

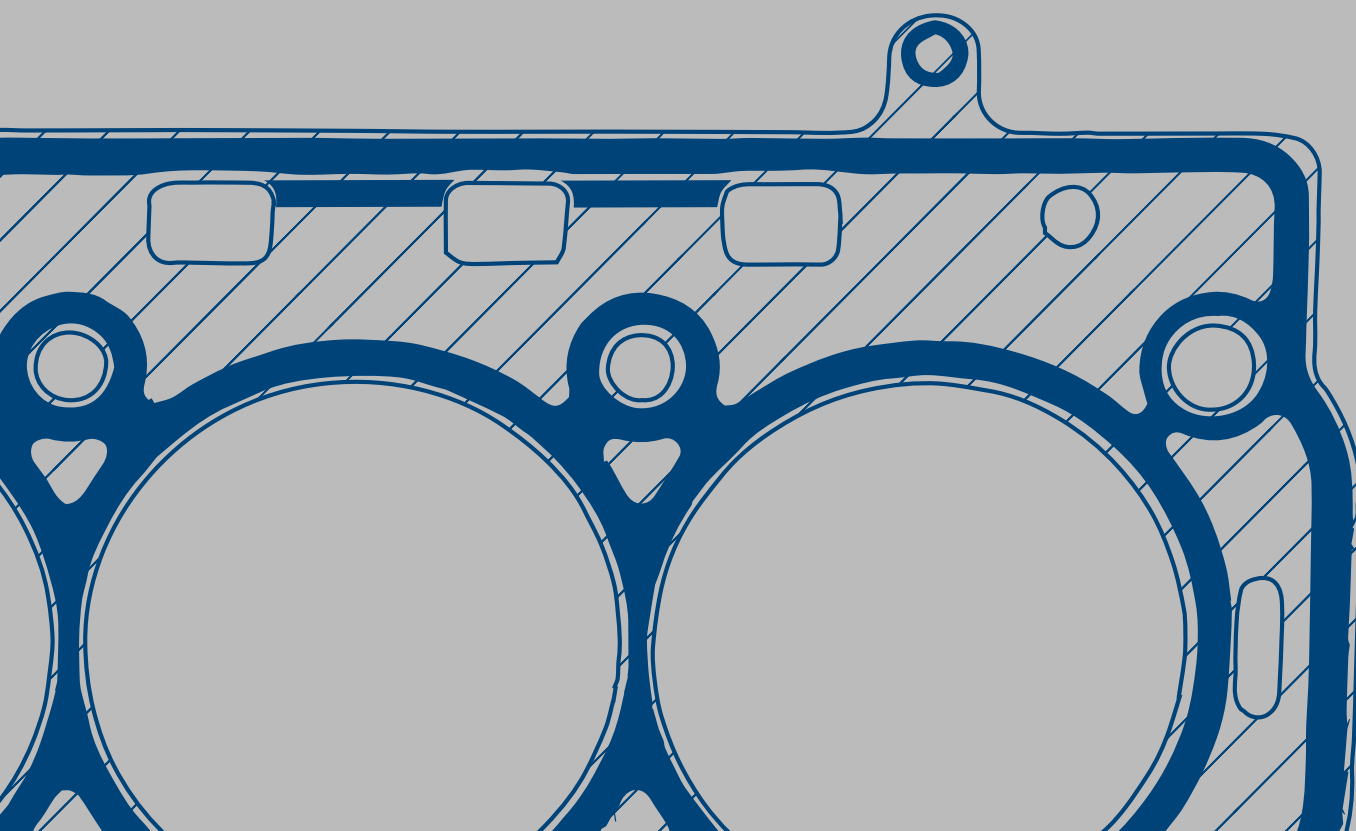

guarnitauto

Italian Excellence - since 1954



CAR CATALOGUE 2022 CATALOGO AUTO 2022

www.guarnitauto.com

 **TecAlliance**
Data Supplier

INDEX

P/N	MAKE	DISPLACEMENT	PAGE
102266-5250	BMW	1.6 - 2.0 16V	6
102268-5250	BMW	1.6 - 2.0 16V	7
102270-5250	BMW	1.6 - 2.0 16V	8
102267-5250	BMW	2.5 - 2.8 - 3.0 24V	9
102274-5251	BMW - MINI - TOYOTA	1.6 DI 16V	10
042275-1000	BMW	2.0 D 16V	11
102275-5251	BMW - MINI - TOYOTA	2.0 Tdi 16V	12
042248-1000	BMW	2.0 16V	13
102248-5251	BMW - LAND ROVER - ROVER	2.0 16V	14
102276-5251	BMW	3.0 DS 24V	15
102277-5251	BMW	2.5 DS 24V - 3.0 DS 24V	16
033311-1000	CHEVROLET - DAEWOO	0.8 6V	17
033314-1000	CHEVROLET - DAEWOO	1.0 8V - 1.2 8V	18
053314-1000	CHEVROLET - DAEWOO	1.0 - 1.2 8V	19
053321-1000	CHEVROLET	1.2 -1.2 LPG 16V	20
053323-1000	CHEVROLET - DAEWOO	1.4 16V - 1.6 16V	21
051113-1072	FIAT GROUP	1.0 8V - 1.1 8V - 1.2 8V	22
051113-7072	FIAT GROUP	1.0 8V - 1.1 8V - 1.2 8V	23
051070-1072	FIAT GROUP	1.2 8V	24
051070-7072	FIAT GROUP	1.2 8V	25
051139-1072	FIAT GROUP	1.2 GASOLINE / GAS BIFUEL 8V	26
051139-7072	FIAT GROUP	1.2 GASOLINE / GAS BIFUEL 8V	27
051140-1072	FIAT GROUP	1.0 8V - 1.1 8V - 1.2 8V	28
051140-7072	FIAT GROUP	1.0 8V - 1.1 8V - 1.2 8V	29
051099-1000	FIAT GROUP - FORD - TATA	1.2 8V - 1.4 8V 1.2-1.4-1.4 LPG 8V 1.2-1.4-NAT.POWER 8V	30
051099-1052	FIAT GROUP - FORD - TATA	1.2 8V - 1.4 8V 1.2-1.4-1.4 LPG 8V 1.2-1.4-NAT.POWER 8V	31
101099-5275	FIAT GROUP - FORD - TATA	1.2-1.4 8V	32
051124-1000	FIAT GROUP	1.2 8V - 1.2 LPG 8V	33
051124-1052	FIAT GROUP	1.2 8V - 1.2 LPG 8V	34
053696-1019	FIAT PROFESSIONAL	1.4 8V	35
051126-1000	FIAT GROUP	1.4 16V	36
051115-1000	FIAT GROUP - OPEL	1.4 TB-BIFUEL 16V 1.4 TB 16V 1.4 T-JET 16V - 1.4 16V	37
051127-1000	FIAT GROUP	1.4 TB 16V	38
051128-1000	FIAT GROUP	1.4 16V	39

P/N	MAKE	DISPLACEMENT	PAGE
051132-1000	FIAT GROUP	1.4 TB 16V	40
051130-1000	FIAT GROUP - SUBARU SUZUKI	1.3 - 1.5 - 1.6 16V	41
NEW 051135-1052	FIAT GROUP	1.4 16V	42
NEW 051136-1000	FCA GROUP	1.4 16V	43
051131-1000	FIAT GROUP	1.6 16V	44
050254-1000	FIAT GROUP	1.9 - 2.2 JTS 16V	45
041081-1000	FIAT GROUP - OPEL - SUZUKI	1.3 MULTIJET 16V	46
041121-1000	CHEVROLET - PSA GROUP - FIAT GROUP - FORD - OPEL - SUZUKI	1.3 MULTIJET 16V	47
041081-1051	CHEVROLET - PSA GROUP - FIAT GROUP - FORD - OPEL - SUZUKI	1.3 MULTIJET 16V	48
081081-1051	FIAT GROUP - CHEVROLET - CITROEN OPEL - SUZUKI - TATA	1.3 D 16V (MULTIJET)	49
101081-5251	FIAT GROUP - OPEL PSA GROUP - SUZUKI	1.3 JTD - MULTIJET	50
041116-1000	FIAT GROUP - OPEL	1.6-2.0 JTDM 16V 1.6-2.0 MULTIJET 16V 1.6 D - 1.6 CDTI 16V 2.0 JTD	51
081117-1051	FIAT GROUP - OPEL	1.6 -2.0 JTDM - MULTIJET - CDTI 16V	52
101116-5251	FIAT GROUP - OPEL - SUZUKI	1598 - 1956 CC JTDM 16V	53
101074-5251	FIAT GROUP	1.9 DS	54
101075-5251	FIAT GROUP - OPEL - SAAB SUZUKI	1.9 JTD 8V	55
081118-1051	FIAT GROUP - OPEL	1.9 MULTIJET 8V - 16V	56
051524-1000	FORD	1.0 12V ECOBOOST	57
081524-9970	FORD	1.0 12V	58
NEW 051538-1052	FORD	1.0 12V	59
052582-1000	FORD - MAZDA	1.25 16V	60
051521-1000	FORD	1.25 16V	61
051515-1051	FORD	1.4 16V	62
051522-1000	FORD	1.4 16V	63
052590-1000	FORD	1.6i 16V	64
052599-1000	FORD	1.6i 16V	65
051512-1000	FORD - MAZDA - VOLVO	1.6 16V	66
051514-1000	FORD	1.6 Ti 16V	67
051523-1000	FORD	1.6 Ti-Flexifuel 16V	68
102566-5250	FORD	1.6 8V	69
051525-1000	FORD	1.6 16V	70
101525-5250	FORD - VOLVO	1.6 16V ECOBOOST	71
042588-1051	FORD	1.8 DI - TDCI - TDDI 8V	72
082588-1000	FORD	1.8 TDCI 8V - 1.8 TD DI 8V 1.8 TD 8V - 1.8 DI 8V	73

P/N	MAKE	DISPLACEMENT	PAGE
042564-1051	FORD	2.0 TDCI - TDDI - DI 16V	74
042565-1051	FORD	2.0 TDCI - TDDI - DI 16V	75
041530-1099	FORD	2.0 TDDI 16V - 2.0 TDCI 16V 2.2 TDCI 16V	76
041529-1099	FORD	2.2 TDCI 16V	77
102564-5251	FORD	2.0 TDDI 16V - 2.0 TDCI 16V 2.0 DI 16V - 2.2 TDCI 16V	78
041519-9951	FIAT PROFESSIONAL - PSA GROUP	2.2 HDI 16V - 2.2 MJTD 16V	79
081519-1000	FIAT PROFESSIONAL - FORD - PSA GROUP	2.2 HDI 16V - 2.2 MJTD 16V 2.0 TDDI 16V - 2.0 TDCI 16V 2.2 TDCI 16V	80
101519-5251	FIAT PROFESSIONAL - FORD - PSA GROUP	2.2 HDI 16V - 2.2 MJTD 16V 2.0 TDDI 16V - 2.0 TDCI 16V 2.2 TDCI 16V	81
041534-1099	FORD - LAND ROVER	2.2 TDCI 16V	82
101534-5251	FORD - LAND ROVER	2.2 TDCI 16V	83
011520-1099	FORD - LAND ROVER	2.4 TDCI	84
041520-1099	FORD - LAND ROVER	2.4 DI - TDCI - TDE - TD4 4X4 16V	85
102565-5251	FORD - LAND ROVER	2.4 DI 16V - 2.4 TDE 16V 2.4 TDCI 16V - 2.4 TD4 4X4 16V	86
052027-1000	HYUNDAI	1.112V	87
NEW 032011-1000	HYUNDAI	1.0 12V	88
032027-1000	HYUNDAI	1.112V	89
052037-1000	HYUNDAI - KIA	1.0 12V - 1.112V	90
102040-5250	HYUNDAI	1.112V	91
052040-1000	HYUNDAI	1.112V	92
052035-1000	HYUNDAI	1.3 12V	93
052038-1000	HYUNDAI - KIA	1.4 16V	94
051626-1000	HYUNDAI - KIA	1.4 16V - 1.6 16V - 1.6 CVVT 16V	95
102044-5251	HYUNDAI - KIA	2.0 CRDI 16V	96
042039-1000	HYUNDAI	1.5 CRDI	97
102042-5251	HYUNDAI - KIA	2.2 CRDI 16V	98
012044-1099	HYUNDAI - KIA	2.0 - 2.2 CRDI 16V	99
041623-1000	KIA	2.5 CRDI 16V	100
101623-5251	KIA	2.5 CRDI 16V	101
043826-1099	JAGUAR - LAND ROVER - PSA GROUP	2.7 DS 24V - 3.0 DS 24V	102
032920-1000	MAZDA	2.2 DS 16V	103
053037-1052	MERCEDES BENZ	2.2 CDI 16V	104
083037-1051	MERCEDES BENZ	2.2 CDI 16V	105
053071-1052	DODGE - JEEP - MERCEDES BENZ	2.2 CDI - CRD 16V MODEL YEAR TO / FINO A 12-2011	106
053072-1052	INFINITI - MERCEDES BENZ	2.2 CDI 16V MODEL YEAR FROM / ANNO DA 12-2011	107

P/N	MAKE	DISPLACEMENT	PAGE
051911-1052	MINI	1.4 16V - 1.6 16V	108
053123-1000	MITSUBISHI	1.3 12V	109
NEW 033123-1000	MITSUBISHI	1.3L - 1.5L	110
053113-1000	MITSUBISHI	1.6i 16V	111
NEW 013124-1099	MITSUBISHI	2.5 DS 16V	112
013114-1000	HYUNDAI - KIA - MITSUBISHI	2.5	113
103114-5251	HYUNDAI - KIA - MITSUBISHI	2.5 TD - TDI	114
052450-1000	NISSAN	1.4i 16V	115
052455-1000	NISSAN	1.6 16V	116
052451-1000	NISSAN	1.6 16V	117
042454-1000	NISSAN	2.5 DCI 16V	118
102454-5253	NISSAN	2.5 DCI 16V	119
042456-1000	NISSAN	2.5 dCi - dCi 16V	120
102456-5251	NISSAN	2.5 dCi - dCi 16V	121
042453-1000	NISSAN	3.0 DTI 16V - 3.0 DI 4WD 16V	122
102453-5251	NISSAN - OPEL - RENAULT	3.0 DTI 16V - 3.0 DI 4WD 16V 3.0 DCI 16V	123
042457-1099	NISSAN - RENAULT TRUCKS	3.0 DCI - DTI - DXI 16V	124
102457-5251	NISSAN - RENAULT TRUCKS	3.0 DCI - DTI - DXI 16V	125
053590-1000	OPEL - SUZUKI	1.0 12V	126
053590-1052	OPEL - SUZUKI	1.0 12V	127
053597-1052	OPEL	1.0 12V	128
058411-1000	NISSAN - OPEL - SUZUKI	1.0 12V - 1.0 LPG 16V - 1.0 16V	129
053596-1000	OPEL - SUZUKI	1.2 - 1.2 LPG 16V 1.2 - 1.2 VVT 16V	130
053589-1000	OPEL - SUZUKI	1.2-1.4 16V	131
053589-1052	OPEL - SUZUKI	1.2-1.4 16V	132
053589-5251	OPEL - SUZUKI	1.2-1.4 16V	133
053599-1000	CHEVROLET - DAEWOO - OPEL	1.2-1.2 LPG-1.4 16V	134
053599-1052	CHEVROLET - DAEWOO - OPEL	1.2-1.2 LPG-1.4 16V	135
058412-1000	CHEVROLET - DAEWOO - OPEL	1.4T 16V - 1.4 16V - 1.4 AWD 16V 1.4-T LPG 16V	136
058412-1052	CHEVROLET - DAEWOO - OPEL	1.4T 16V - 1.4 16V - 1.4 AWD 16V 1.4-T LPG 16V	137
058416-5242	CHEVROLET - OPEL	1.2 - 1.4 16V	138
058417-5242	CHEVROLET - OPEL	1.4 16V	139
053570-1052	OPEL	1.4 16V	140
053571-1052	OPEL	1.6 16V	141

INDEX

P/N	MAKE	DISPLACEMENT	PAGE
053586-1052	OPEL - FIAT GROUP	1.6 16V	142
053591-1052	OPEL	1.6 TURBO 16V	143
053592-1000	FIAT GROUP - CHEVROLET - OPEL	1.8 MPI 16V - 1.8-LPG 16V 1.8 AWD 16V - 1.8-GH.G. 16V	144
053592-1052	FIAT GROUP - CHEVROLET - OPEL	1.8 MPI 16V - 1.8-LPG 16V 1.8 AWD 16V - 1.8-GH.G. 16V	145
043587-1000	HONDA - OPEL	1.7 DTI-CDTI 16V	146
103588-5251	CHEVROLET - HONDA - OPEL	1.7 DTI 16V - 1.7 CDTI 16V	147
043594-1000	OPEL	1.7 CDTI 16V	148
103594-5251	CHEVROLET - OPEL	1.7 CDTI 16V	149
048413-1099	OPEL - CHEVROLET	2.0 DT 16V	150
043567-1000	OPEL - SAAB	2.0 DS - 2.2 DS 16V	151
103567-5251	OPEL - SAAB	2.0 DS - 2.2 DS 16V	152
048414-1099	OPEL	1.9 CDTI 16V	153
053689-1000	DAIHATSU - PSA GROUP - SUBARU - TOYOTA	1.0i 12V	154
053609-1019	PSA GROUP	1.18V - 1.3 8V - 1.4 8V	155
052332-1019	PSA GROUP	1.18V - 1.3 8V - 1.4 8V	156
043609-1099	PSA GROUP	1.0 8V - 1.18V - 1.3 8V - 1.4 8V	157
103642-1915	PSA GROUP	1.18V - 1.3 8V - 1.4 8V	158
102332-1915	PSA GROUP	1.18V - 1.3 8V - 1.4 8V	159
053673-1051	PSA GROUP	1.1i 8V	160
053698-1019	PSA GROUP	1.4i 8V	161
033699-1019	PSA GROUP	1.4i 8V	162
053686-1000	PSA GROUP	1.4 16V	163
NEW 052333-1052	PSA GROUP	1.2 12V	164
053693-1000	PSA GROUP	1.6i 16V	165
053695-1000	MINI - PSA GROUP	1.6 16V - 1.4 16V	166
053695-1052	MINI - PSA GROUP	1.6 16V - 1.4 16V	167
053695-5251	MINI - PSA GROUP	1.6 16V - 1.4 16V	168
053694-1000	MINI - PSA GROUP	1.6 16V	169
053694-1052	MINI - PSA GROUP	1.6 16V	170
053694-5251	MINI - PSA GROUP	1.6 16V	171
083674-1000	PSA GROUP	1.6 16V	172
043678-1000	FORD - MAZDA - TOYOTA	1.4 HDI 8V - 1.4 TDCI 8V	173
083678-1051	FIAT GROUP - FORD - MAZDA - PSA - SUZUKI - TOYOTA - VOLVO	1.4 TD 8V - 1.6 TD 16V	174
103678-5251	PSA GROUP - FORD - MAZDA - TOYOTA	1.4 HDI 8V - 1.4 TDCI 8V	175
043688-1000	PSA GROUP - FIAT - FORD - MAZDA - MINI - SUZUKI - VOLVO	1.6 HDI 16V - 1.6 D MULTIJET 1.6 TDCI 16V - 1.6 16V - 1.6 D 16V	176

P/N	MAKE	DISPLACEMENT	PAGE
103688-5251	PSA GROUP - FIAT - FORD - MAZDA - MINI SUZUKI - VOLVO	1.6 HDI 16V - 1.6 TDCI 16V	177
041526-1099	PSA GROUP - FORD MAZDA - VOLVO	1.5 - 1.6 HDI 8V	178
041533-1099	PSA GROUP - FIAT MAZDA MITSUBISHI - TOYOTA	1.4 - 1.6 HDI 8V	179
101535-5251	FORD - MAZDA - PSA GROUP VOLVO	1.6 HDI - TDCi 8V	180
101536-5251	FIAT GROUP - OPEL PSA GROUP - TOYOTA	1.6 HDI - TDCi 8V	181
101537-5251	FORD - PSA GROUP	1.4 HDI - 1.5 TDCi	182
103658-5251	PSA GROUP - FIAT - SUZUKI	1.9 TD 8V	183
043670-1000	PSA GROUP FIAT - TOYOTA	1.9 D 8V	184
103670-5251	PSA GROUP - FIAT - TOYOTA	1.9 D 8V	185
043671-1000	PSA GROUP FIAT GROUP - SUZUKI	2.0-2.2 HDI 8V - 2.0 JTD 8V	186
103671-5252	PSA GROUP - FIAT SUZUKI	2.0 - JTD 8V	187
043690-1099	FIAT GROUP - FORD PSA GROUP - VOLVO	2.0 HDI - TDCI 16V	188
053752-1051	NISSAN - RENAULT	1.2 8V	189
053752-1052	NISSAN - RENAULT	1.2 8V	190
053763-1000	NISSAN - RENAULT	1.2 16V	191
053770-1000	DACIA - RENAULT	1.2 16V	192
053781-1000	RENAULT	1.2 16V	193
053780-1000	RENAULT	1.4 16V	194
053784-1000	DACIA - RENAULT	1.4-1.6 8V - 1.4-MPI 8V 1.6-BIFUEL 8V - 1.6-LPG 8V	195
053769-1000	DACIA - RENAULT	1.6 16V	196
053766-1052	NISSAN - RENAULT	1.5 DCI 8V	197
053776-1000	NISSAN - RENAULT	1.5 DS 8V	198
053783-1000	DACIA - NISSAN - RENAULT	1.5 DCI 8V	199
043776-1051	DACIA - NISSAN - RENAULT	1.5 DCI 8V	200
103776-5210	NISSAN - RENAULT	1.5 DS 8V	201
103793-5210	DACIA - NISSAN - RENAULT	1.5 DS 8V	202
053793-1000	NISSAN - RENAULT	1.5 DS 8V	203
053794-1000	DACIA - NISSAN - RENAULT	1.5 DS 8V	204
053775-1000	DACIA - MERCEDES - RENAULT - NISSAN	1.5 DCI 8V - CDI 1.5 D 8V	205
103790-5250	FIAT GROUP - MERCEDES BENZ - NISSAN - OPEL - RENAULT	1.6 DCI 16V	206
043758-1000	MITSUBISHI - NISSAN - OPEL - RENAULT - VOLVO	1.9 DiD - 1.9 DTI - 1.9 DCI - 1.9 TD	207
043785-1000	NISSAN - OPEL - RENAULT	2.0 DCI - CDTI 16V	208
NEW 053785-1000	NISSAN - RENAULT - MITSUBISHI - OPEL	2.0L 16V	209
NEW 053786-1000	NISSAN - RENAULT - MITSUBISHI - OPEL	2.0L 16V	210

P/N	MAKE	DISPLACEMENT	PAGE
103785-5250	NISSAN - RENAULT	2.0 DCI 16V	211
103786-5250	NISSAN - OPEL - RENAULT	2.0 DCI 16V	212
053772-1000	NISSAN - OPEL - RENAULT	2.5 DCI 16V - 2.5 DTI 16V	213
053789-1000	NISSAN - OPEL - RENAULT	2.3 dCi 16V	214
103792-5250	MERCEDES - NISSAN - OPEL - RENAULT	2.3 DS 16V	215
083785-9970	MERCEDES BENZ - NISSAN - OPEL - RENAULT	2.0 - 2.3 DCI 16V	216
054517-1052	SMAR - MCC	1.0	217
053923-1000	SUZUKI	1.3 - 1.6 16V	218
054416-1000	TOYOTA	1.0 16V	219
054417-1000	TOYOTA	1.3 - 1.5 16V	220
054459-1000	DAIHATSU - TOYOTA	1.3 16V	221
054420-1000	TOYOTA	1.4 - 1.6 - 1.8 16V	222
044431-1000	MINI - TOYOTA	1.4 D 8V	223
044447-1000	TOYOTA	2.0 TD 16V	224
044462-1000	TOYOTA	2.0 - 2.2 D 16V	225
044465-1099	TOYOTA	3.0 D ID 16V	226
104465-5251	TOYOTA	3.0 D ID 16V	227
NEW 054786-1052	VW GROUP	1.2 12V	228
054788-5251	VW GROUP	1.2 6V	229
054773-1052	VW GROUP	1.4i 16V	230
084773-1000	VW GROUP	1.4i - 1.6i 16V	231
054217-1000	VW GROUP	1.4 TSI-TFSI 16V	232
054227-1000/52	VW GROUP	1.4 TSI - TFSI-TSI MULTIFUEL 16V	233
084227-1000	VW GROUP	1.4 TSI - TFSI 16V	234
054783-1000	VW GROUP	1.4 - 1.6 FSI 16V	235
084232-1000	VW GROUP	1.6 FSI 16V	236
054763-1052	VW GROUP	1.6i 8V	237
054777-1052	VW GROUP	1.6i 8V	238
054778-1052	VW GROUP	1.6i 8V	239
054795-1052	VW GROUP	1.6i 8V	240
054799-1052	VW GROUP	1.6i 8V	241
084763-1000	VW GROUP	1.6i 8V	242
104763-5250	VW GROUP	1.6i 8V	243
054115-1000	VW GROUP	1.6 8V	244
054769-1052	VW GROUP	1.6 - 1.8i 8V	245
054767-1052	VW GROUP	1.8i 20V	246

P/N	MAKE	DISPLACEMENT	PAGE
054792-1052	VW GROUP	2.0i 8V	247
NEW 054221-1052	VW GROUP	2.0 16V	248
054230-1052	VW GROUP	1.8 - 2.0 TSI - TFSI 16V	249
044218-1099	VW GROUP	1.6 TDI 16V	250
104224-5250	VW GROUP	2.8 30V	251
044233-1099	VW GROUP	1.6 Tdi 16V	252
084218-1000	VW GROUP	1.6 - 2.0 TDI 16V	253
104218-5251	VW GROUP	1.6 TDI 16V	254
104742-5251	VW GROUP	1.9 D-TD	255
104745-5251	VW GROUP - FORD	1.9 SDI-Tdi	256
104768-5251	VW GROUP - FORD	1.9 SDI-Tdi	257
114768-8000	VW GROUP	1.9 SDI - TDI 8V	258
084768-1000	VW GROUP - FORD	1.9 - 2.0 TDI	259
104791-5251	VW GROUP - FORD	1.9 Tdi	260
044797-1051	MITSUBISHI - VW GROUP	2.0 TDI 16V - 2.0 DI-D 16V	261
104797-5251	VW GROUP - MITSUBISHI	2.0 Tdi 16V	262
044226-1099	VW GROUP	1.9 - 2.0 Tdi 8V	263
044220-1099	VW GROUP	2.0 TDI 16V	264
104220-5252	VW GROUP	2.0 TDI 16V	265
044752-1000	VW GROUP	2.4 DS 10V	266
104751-5251	VW GROUP - VOLVO	2.5 D. 10V	267
104752-5251	VW GROUP	2.4 DS 10V	268
044231-1099	VW GROUP	2.0 Tdi 16V	269
NEW 104231-5252	VW GROUP	2.0 TDI 16V	270
094772-1000	VW GROUP	1.2 TDI - 1.4 TDI - 1.9 TDI	271
094797-1000	VW GROUP	1.9 TDI	272
094228-1000	VW GROUP	1.9 TDI - 2.0 TDI	273

102266-5250

BMW

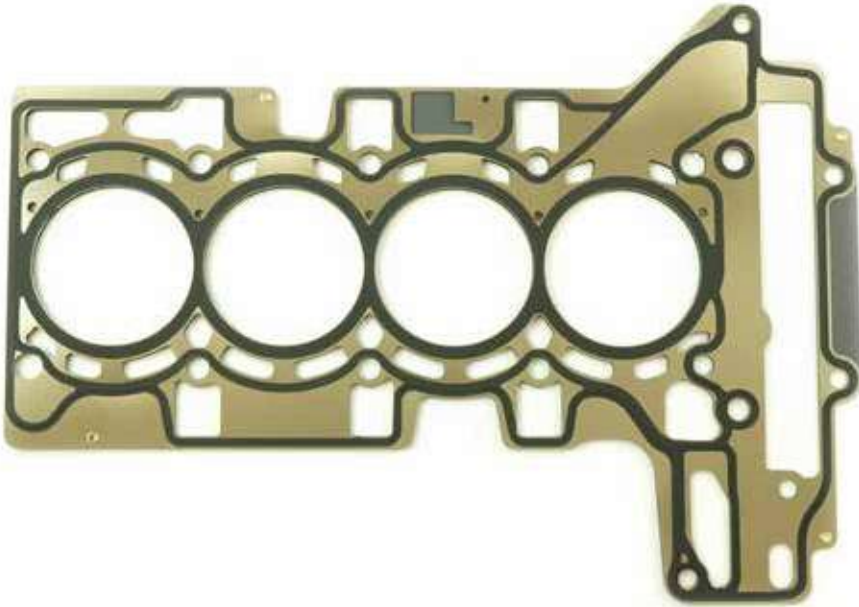

ENGINES* | MOTORI*

DISPLACEMENT
1.6 - 2.0 16V

N20B16 - N20B20A - B - D - N26B20A

MODELS* | MODELLI*

BMW

SERIE 1 125i - SERIE 2 220i - 228i - SERIE 3 320i - 328i 2.0 16V - SERIE 4 420i - 428i - SERIE 5 520i - 528i 2.0 16V - X1-16i - X318i 1.6 16V - X1 20i - 28i - X3 20i - 28i - X4 20i-28i - X5 40E - Z418i - 20i-28i 2.0 16V

DESCRIPTION	P/N	CROSS REFERENCES				
		OE	RNZ	EK	AJ	PY
MLS HEAD GASKET 0,70 MM	102266-5250	11127620697	61-10019-00	364.525		

102268-5250

BMW



ENGINES* | MOTORI*

DISPLACEMENT
1.6 -2.0 16V

N40 B16A - N42 B18A - N42 B20A-B - N45 B16 TU2 - N46 B18A - N45 B16-A - N46 B20A-B20B-B20C (Until/Fino al 2007)

MODELS* | MODELLI*

BMW

SERIE 1 116i 1.6 16V - 116i - 118i - 120i 2.0 16V - SERIE 3 316i 1.6 16V - 318i - 320i 2.0 16V - X3 20i - Z4 20i 2.0 16V

DESCRIPTION	P/N	CROSS REFERENCES				
		OE	RNZ	EK	AJ	PY
MLS HEAD GASKET 0,40 MM	102268-5250	11127509710	61-36255-00	746.902	10137400	AC5440

*Find out our complete range: www.athena.eu | *Per ulteriori informazioni consultate il catalogo online nel nostro sito: www.athena.eu

102270-5250

BMW

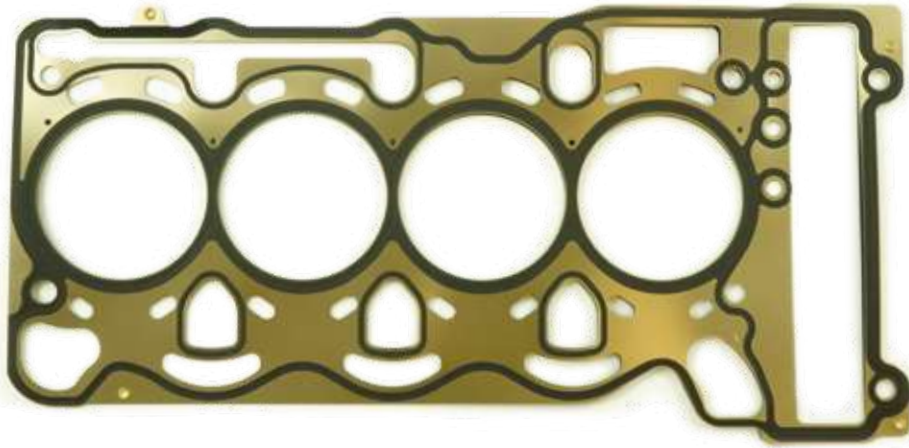

ENGINES* | MOTORI*

DISPLACEMENT
1.6 -2.0 16V

N40 B16A - N42 B18A - N42 B20A-B - N43 B20A - N45 B16 TU2 - N46 B18A - N45 B16-A
- N46 B20A-B20B-B20BD-B20C (From/Dal 2007)

MODELS* | MODELLI*

BMW

SERIE 1 116i 1.6 16V - 116i - 118i - 120i 2.0 16V - SERIE 3 316i 1.6 16V - 318i - 320i 2.0 16V - SERIE
5 520i 2.0 16V - X118i - X3 20i - Z4 20i 2.0 16V

DESCRIPTION	P/N	CROSS REFERENCES				
		OE	RNZ	EK	AJ	PY
MLS HEAD GASKET 0,50 MM	102270-5250	11127563412	61-37625-00	353.264	10189200	

*Find out our complete range: www.athena.eu | *Per ulteriori informazioni consultate il catalogo online nel nostro sito: www.athena.eu

102267-5250

BMW



ENGINES* | MOTORI*

DISPLACEMENT
2.5 - 2.8 - 3.0 24V

—
M52 B25-B28-B28GG-B28TU (From/Dal 1998) - M54 256S5-306S3-B25-B30

MODELS* | MODELLI*

BMW

—
SERIE 3 323i - TI-CI - 325i-XI-TI-CI - 523i - 525i - X3 - Z4 2.5i 24V - SERIE 3 328i-CI - 330i-XI - 528i - 728i-IL - Z3 2.8i 24V - SERIE 3 330i-XI-CI - 530i - 730i-IL - X3 - X5 - Z3 3.0 24V

DESCRIPTION	P/N	CROSS REFERENCES				
		OE	RNZ	EK	AJ	PY
MLS HEAD GASKET 0,70 MM	102267-5250	11127501304	61-33070-00	361.473	10127200	AC5900

*Find out our complete range: www.athena.eu | *Per ulteriori informazioni consultate il catalogo online nel nostro sito: www.athena.eu

102274-5251

BMW - MINI - TOYOTA



ENGINES* | MOTORI*

DISPLACEMENT
1.6 DI 16V
—
N47C16A - N47D16A

MODELS* | MODELLI*

BMW
—
SERIE 1 114d - 116d (F20-21) 1.6 DI 16V

MINI
—
ONE D - COOPER D - COUNTRYMAN - CLUBMAN - PACEMAN 1.6 DI 16V

TOYOTA
—
AURIS (E18) - AVENSIS (T27) - VERSO (R2) 1.6 D4-DI 16V

DESCRIPTION	P/N	CROSS REFERENCES				
		OE	RNZ	EK	AJ	PY
MLS HEAD GASKET 0,95 MM - 1 HOLE	102274-5251	11128509149	61-10049-00	138.111		
MLS HEAD GASKET 1,05 MM - 2 HOLES	102274-5252	11128509150	61-10049-10	138.121		
MLS HEAD GASKET 1,15 MM - 3 HOLES	102274-5253	11128509151	61-10049-20	138.131		

*Find out our complete range: www.athena.eu | *Per ulteriori informazioni consultate il catalogo online nel nostro sito: www.athena.eu

042275-1000

CYLINDER HEAD GASKET SET - KIT GUARNIZIONI TESTATA BMW



112275-0000

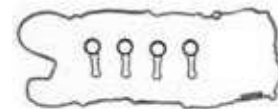

ENGINES* | MOTORI*

DISPLACEMENT | CILINDRATA

2.0 D 16V

CODE | CODICE

N47 D20A - N47 D20C

MODELS* | MODELLI*

BMW

SERIES 1 116D - 118D - 120D (E81-E87) 2.0 D 16V
 SERIES 1 118D - 120D (E82-E88) 2.0 D 16V
 SERIES 3 316D - 318D - 320D - 320D XDRIVE (E90) 2.0 D 16V
 SERIES 3 TOURING 318D - 320D - 320D XDRIVE (E91) 2.0 D 16V
 SERIES 3 TOURING 320D (E92-E93) - 320D XDRIVE (E92) 2.0 D 16V
 SERIES 5 520D (E60-E61) 2.0 D 16V
 X1 SDRIVE 16D - 18D - XDRIVE 18D - SDRIVE - XDRIVE 20D (E84) 2.0 D 16V
 X3 XDRIVE 18D - 20D (E83) 2.0 D 16V

DESCRIPTION DESCRIZIONE	P/N		CROSS REFERENCES CORRISPONDENZE			
	GA	OE	RNZ	EK	AJ	PY
CYLINDER HEAD GASKET SET, WITHOUT H.G. KIT GUARNIZIONI TESTATA, SENZA T.C.	042275-1000	11127807293	02-39346-01	537.540	53030600	CC5410
CYLINDER HEAD COVER GASKET SET KIT GUARNIZIONI COPRITESTATA	112275-0000	11127807017	15-39346-01	530.060	56044500	HM5387

*Find out our complete range: www.athena.eu | *Per ulteriori informazioni consultate il catalogo online nel nostro sito: www.athena.eu

102275-5251

BMW - MINI - TOYOTA



ENGINES* | MOTORI*

DISPLACEMENT
2.0 Tdi 16V

N47D20C - N47D20D (BMW) - N47C20A (MINI) - 2WW (TOYOTA)

MODELS* | MODELLI*

BMW

116-118-120d (F20-1) - 218-220-225d (F22) 2.0 Tdi 16V
316-318-320 (E90-1-F31) - 420-425 (F82-3) - 518-520-525 (F10-1) 2.0 Tdi 16V
X1 18d-20d-25d (E84) - X3 18d-20d-25d (F25) 2.0Tdi 16V

MINI

COUNTRYMAN - CLUBMAN - PACEMAN Cooper 2.0 Tdi 16V

TOYOTA

AVENSIS 2.0D-4D - RAV 4 IV 2.0D Tdi 16V

DESCRIPTION	P/N	CROSS REFERENCES				
		OE	RNZ	EK	AJ	PY
MLS HEAD GASKET TH. 1,45 MM - 1 NOTCH	102275-5251	11128509146	61-38110-00	575.051	10194600	
MLS HEAD GASKET TH. 1,55 MM - 2 NOTCHES	102275-5252	11128509147	61-38110-10	019.321	10194610	
MLS HEAD GASKET TH. 1,65 MM - 3 NOTCHES	102275-5253	11128509148	61-38110-20	019.331	10194620	

042248-1000

BMW



ENGINES* | MOTORI*

DISPLACEMENT
2.0 16V

—
M47 D20 (204D4) - D20TU
M47N 204 D4-D5

MODELS* | MODELLI*

BMW

—
SERIE 1 118 D 16V (E87) - SERIE 1 120 D 16V (E87) - SERIE 3 318 D 16V (E46 - E90)
- SERIE 3 318 D COMPACT-TOURING 16V (E46) - SERIE 3 318 D TOURING 16V
(E91) - SERIE 3 320 D 16V (E46 - E90) - SERIE 3 320 D COMPACT-TOURING 16V
(E46) - SERIE 3 320 CD COUPÉ-CABRIO 16V (E46) - SERIE 3 320 D TOURING 16V
(E91) - SERIE 5 520 D 16V (E60) - SERIE 5 520 D TOURING 16V (E61)
- X3 2.0 D 16V (E83)

DESCRIPTION	P/N	CROSS REFERENCES				
		OE	RNZ	EK	AJ	PY
HEAD SET WITHOUT H.G.	042248-1000	11 12 7 788 072	02-36878-01	123.740	53016500	CC5410
CYLINDER HEAD COVER	112248-8000	11 12 7 794 495	71-36878-00	123.590	11109300	JM5167

*Find out our complete range: www.athena.eu | *Per ulteriori informazioni consultate il catalogo online nel nostro sito: www.athena.eu

102248-5251

CYLINDER HEAD GASKET - GUARNIZIONE TESTATA
BMW - LAND ROVER - ROVER



ENGINES* | MOTORI*

DISPLACEMENT | CILINDRATA

—
2.0 D 16V

CODE | CODICE

—
M47D20 (204D4) - 204D3 - M47 - M47R

MODELS* | MODELLI*

BMW

—
SERIES 1 118D - 120D (E87) 2.0 D 16V
SERIES 3 318D-TD - 320D -TD-CD (E46) 2.0 D 16V
SERIES 3 318D - 320D (E90-E91) 2.0 D 16V
SERIES 5 520D (E60-E61) 2.0 D 16V
X3 (E83) 2.0 D 16V

LAND ROVER

—
FREELANDER (L314) 2.0 TD4 4X4 16V

ROVER

—
75 (RJ) 2.0 CDT 16V

DESCRIPTION DESCRIZIONE	P/N		CROSS REFERENCES CORRISPONDENZE			
	GA	OE	RNZ	EK	AJ	PY
CYLINDER HEAD GASKET, MLS TH. 1,45 mm 1 NOTCH GUARNIZIONE TESTATA, MLS SP. 1,45 mm 1 TACCA	102248-5251	11127790052 LVB101820L	61-36455-00	268.340	10152100	AC5411
CYLINDER HEAD GASKET, MLS TH. 1,55 mm 2 NOTCHES GUARNIZIONE TESTATA, MLS SP. 1,55 mm 2 TACCHE	102248-5252	11127790053 LVB101830L	61-36455-10	268.350	10152110	AC5420
CYLINDER HEAD GASKET, MLS TH. 1,65 mm 3 NOTCHES GUARNIZIONE TESTATA, MLS SP. 1,65 mm 3 TACCHE	102248-5253	11127790054 LVB000100L	61-36455-20	268.360	10152120	AC5431

*Find out our complete range: www.athena.eu | *Per ulteriori informazioni consultate il catalogo online nel nostro sito: www.athena.eu

102276-5251

CYLINDER HEAD GASKET - GUARNIZIONE TESTATA BMW



ENGINES* | MOTORI*

DISPLACEMENT | CILINDRATA

—
3.0 DS 24V

CODE | CODICE

—
M57 D30 (306D1)

MODELS* | MODELLI*

BMW

—
SERIES 5 (E39) 530D 3.0 D 24V
SERIES 7 (E38) 730D 3.0 D 24V
X5 (E53) 30D 3.0 D 24V

DESCRIPTION DESCRIZIONE	P/N		CROSS REFERENCES CORRISPONDENZE			
	GA	OE	RNZ	EK	AJ	PY
CYLINDER HEAD GASKET, MLS 1,45 mm, 1 NOTCH GUARNIZIONE, TESTATA, MLS 1,45 mm, 1 TACCA	102276-5251	11122248982	61-35000-00	157.410	10126400	BZ661
CYLINDER HEAD GASKET, MLS 1,55 mm, 2 NOTCHES GUARNIZIONE, TESTATA, MLS 1,55 mm, 2 TACCHE	102276-5252	11122248983	61-35000-10	157.420	10126410	BZ671
CYLINDER HEAD GASKET, MLS 1,65 mm, 3 NOTCHES GUARNIZIONE, TESTATA, MLS 1,65 mm, 3 TACCHE	102276-5253	11122248984	61-35000-20	157.430	10126420	BZ681

*Find out our complete range: www.athena.eu | *Per ulteriori informazioni consultate il catalogo online nel nostro sito: www.athena.eu

102277-5251

CYLINDER HEAD GASKET - GUARNIZIONE TESTATA BMW



ENGINES* | MOTORI*

DISPLACEMENT | CILINDRATA

—

2.5 DS 24V - 3.0 DS 24V

CODE | CODICE

—

M57 D25 (256D2) - M57 D30 (306D2) - M57 D30 (306D4) - N57 306 D2

MODELS* | MODELLI*

BMW

—

SERIES 5 (E60-E61) 525D 2.5 D 24V
 SERIES 5 (E60-E61) 530D - 535D 3.0 D 24V
 SERIES 7 (E65-E66-E67) 730D 3.0 D 24V
 X3 (E83) 3.0 D 24V
 X5 (E53) 3.0 D 24V

DESCRIPTION DESCRIZIONE	CROSS REFERENCES CORRISPONDENZE					
	P/N	GA	OE	RNZ	EK	AJ
CYLINDER HEAD GASKET, MLS 1,45 mm, 1 NOTCH GUARNIZIONE, TESTATA, MLS 1,45 mm, 1 TACCA	102277-5251	11127788587	61-36620-00	428.440	10152400	AG9000
CYLINDER HEAD GASKET, MLS 1,55 mm, 2 NOTCHES GUARNIZIONE, TESTATA, MLS 1,55 mm, 2 TACCHE	102277-5252	11127788588	61-36620-10	428.450	10152410	AG9010
CYLINDER HEAD GASKET, MLS 1,65 mm, 3 NOTCHES GUARNIZIONE, TESTATA, MLS 1,65 mm, 3 TACCHE	102277-5253	11127788589	61-36620-20	428.460	10152420	AG9020

*Find out our complete range: www.athena.eu | *Per ulteriori informazioni consultate il catalogo online nel nostro sito: www.athena.eu

033311-1000

FULL GASKET SET - KIT GUARNIZIONI MOTORE CHEVROLET - DAEWOO

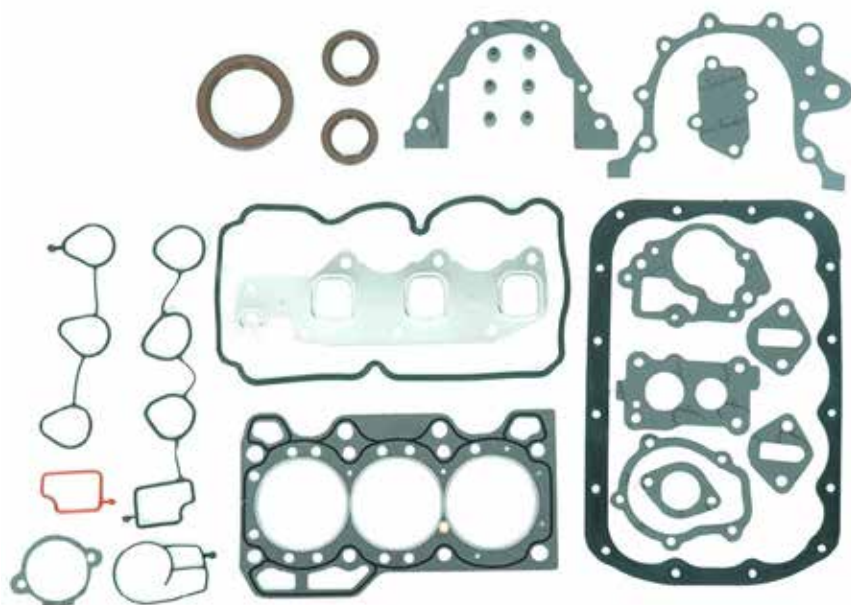

ENGINES* | MOTORI*

DISPLACEMENT | CILINDRATA

—
0.8 6V

CODE | CODICE

—
F8CV - LBF - LQ2

MODELS* | MODELLI*

CHEVROLET

—
MATIZ (M200-M250) 0.8 BZ / 0.8 LPG 6V
SPARK 0.8 6V

DAEWOO

—
MATIZ (M100-M150) 0.8 6V
TICO (KLY3) 0.8 6V

DESCRIPTION DESCRIZIONE	P/N		CROSS REFERENCES CORRISPONDENZE			
	GA	OE	RNZ	EK	AJ	PY
FULL GASKET SET, WITH H.G., WITH OIL SEALS KIT GUARNIZIONI MOTORE, CON T.C., CON PARAOLI	033311-1000	93740053 + 94535484(6X) S1140007	01-53175-02		50225500 50172800	FD5960

*Find out our complete range: www.athena.eu | *Per ulteriori informazioni consultate il catalogo online nel nostro sito: www.athena.eu

033314-1000

FULL GASKET SET - KIT GUARNIZIONI MOTORE CHEVROLET - DAEWOO

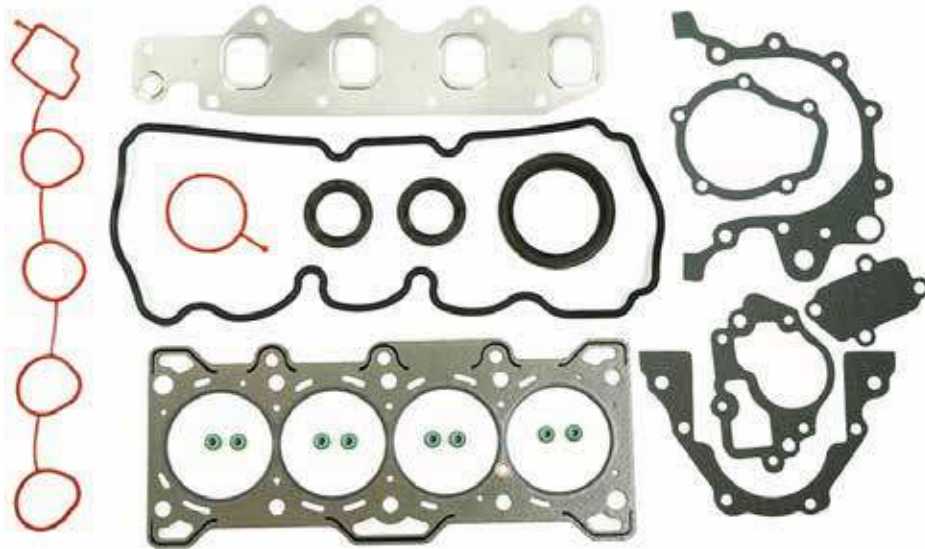

ENGINES* | MOTORI*

DISPLACEMENT | CILINDRATA

1.0 8V - 1.2 8V

CODE | CODICE

B10S - B10S1 - B12S1 - F12S3 - G10CV - L11 - LA2 - LQ4 - LQ5

MODELS* | MODELLI*

CHEVROLET

AVEO (T250-255) 1.2 8V - KALOS 1.2 8V - MATIZ (M200-250) 1.0 LPG 8V
SPARK SX - LPG 1.0 8V

DAEWOO

KALOS (KLAS) 1.2 8V - MATIZ 1.0 8V

DESCRIPTION DESCRIZIONE	P/N		CROSS REFERENCES CORRISPONDENZE			
	GA	OE	RNZ	EK	AJ	PY
FULL GASKET SET, WITH H.G., WITH OIL SEALS KIT GUARNIZIONI MOTORE, CON T.C., CON PARAOLI	033314-1000	93740055 93740056	01-53950-01		50225600	FG7990

053314-1000

CHEVROLET - DAEWOO

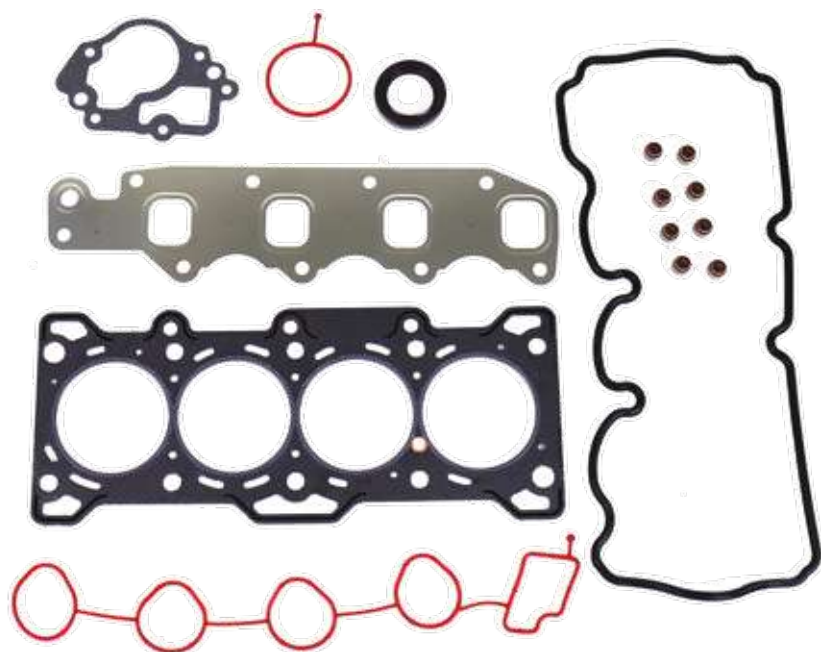

ENGINES* | MOTORI*

DISPLACEMENT
1.0 - 1.2 8V

—
B10S - B10S1 - B12S1 - F12S3 - LA2

MODELS* | MODELLI*

CHEVROLET

—
AVEO 1.2 (T250-255) - KALOS 1.2 - MATIZ 1.0-LPG (M200-250) - SPARK 1.0 SX-LPG

DAEWOO

—
KALOS 1.2 (KLAS) - MATIZ 1.0 8V

DESCRIPTION	P/N	CROSS REFERENCES				
		OE	RNZ	EK	AJ	PY
HEAD SET WITH H.G. AND OIL SEALS	053314-1000				52210600	CG7990

*Find out our complete range: www.athena.eu | *Per ulteriori informazioni consultate il catalogo online nel nostro sito: www.athena.eu

053321-1000
CHEVROLET



ENGINES* | MOTORI*

DISPLACEMENT
1.2 -1.2 LPG 16V
—
B12D1

MODELS* | MODELLI*

CHEVROLET
—
AVEO 1.2 -1.2 LPG 16V - AVEO COOL 1.2 16V - SPARK 1.2 -
1.2 LPG 16V

DESCRIPTION	P/N	CROSS REFERENCES				
		OE	RNZ	EK	AJ	PY
HEAD SET WITH MLS H.G	053321-1000		02-54140-01		52289700	

*Find out our complete range: www.athena.eu | *Per ulteriori informazioni consultate il catalogo online nel nostro sito: www.athena.eu

053323-1000 CHEVROLET - DAEWOO



103323-5250

ENGINES* | MOTORI*

DISPLACEMENT
1.4 16V
1.6 16V
—
F14D3 - F16D3

MODELS* | MODELLI*

CHEVROLET - DAEWOO
—
AVEO 1.4 16V - AVEO 1.6 16V - KALOS 1.4 16V - LACETTI 1.4 16V - LACETTI 1.6 16V -
NUBIRA 1.4 16V - NUBIRA 1.6 16V - OPTRA 1.6 16V

DESCRIPTION	P/N	CROSS REFERENCES				
		OE	RNZ	EK	AJ	PY
HEAD SET WITH MLS H.G AND OIL SEALS	053323-1000		02-54115-01		52261100	
MLS HEAD GASKET	103323-5250	96473400	61-54115-00	471.740	10179200	

*Find out our complete range: www.athena.eu | *Per ulteriori informazioni consultate il catalogo online nel nostro sito: www.athena.eu

051113-1072

CYLINDER HEAD GASKET SET - KIT GUARNIZIONI TESTATA FIAT GROUP



101025-1918



110584-8100



EXPERT'S NOTE - NOTA DELL'ESPERTO

The two intake manifold gaskets allow the set to be used on several engines.
Le due guarnizioni collettore di aspirazione permettono l'applicazione della serie su più motori.

ENGINES* | MOTORI*

DISPLACEMENT | CILINDRATA

1.0 8V - 1.1 8V - 1.2 8V

CODE | CODICE

141C2.000 - 146C3.000
156A2.000 - 156A2.100 - 156A3.000 - 156A2.048 - 156A2.146 - 156A2.246 - 156A4.048
156C.046 - 156C.000 - 160A3.000
176A6.000 - 176A7.000 - 176A8.000 - 176B1.000 - 176B2.000 - 176B4.000
178B5.000 - 178E2.000
"FIRE" Engines Until 1999 / Motori "FIRE" fino al 1999

MODELS* | MODELLI*

AUTOBIANCHI

Y10 1.0 - 1.1 - 1.2 8V

FIAT

CINQUECENTO 1.1 8V - PALIO 1.2 8V - PANDA / VAN / 4X4 1.0 - 1.1 8V
PUNTO 55 - 65 - 75 1.2 8V - SEICENTO 1.1 8V - SIENA 1.2 MPI 8V - TIPO 1.1 8V
PUNTO 1.1 8V - UNO 45 1.0 8V

LANCIA

Y 1.1 - 1.2 8V

Cylinder head gasket's fire rings with molybdenum sulfide treatment.
Anelli parafiamma della guarnizione testata con trattamento al solfuro di molibdeno.



DESCRIPTION DESCRIZIONE	P/N		CROSS REFERENCES CORRISPONDENZE			
	GA	OE	RNZ	EK	AJ	PY
CYLINDER HEAD GASKET SET, WITH H.G., WITH OIL SEALS KIT GUARNIZIONI TESTATA, CON T.C., CON PARAOLI	051113-1072 ^{^A}	5889375 5892383 5893659 5893661 5893663	02-31790-02 02-31790-04 02-31790-07 02-31790-08	144.552 529.471 710.271 710.301	52061100 52089300 52103600 52187900	DV675
CYLINDER HEAD GASKET, COMPOSITE MATERIAL GUARNIZIONE TESTATA IN MATERIALE COMPOSITO	101025-1918	46434102	61-31790-10	710.280	10076500	BV670
CYLINDER HEAD COVER GASKET GUARNIZIONE COPRITESTATA	110584-8100	7688450	71-31734-00	591.076	11008600	JM7156

^{^A} **Unified set with centering dowels** - Kit unificato con boccole di centraggio
Cancels and supercedes 051113-1000 - Annulla e sostituisce 051113-1000

051113-7072

CYLINDER HEAD GASKET SET - KIT GUARNIZIONI TESTATA FIAT GROUP



101025-1918



110584-8100



EXPERT'S NOTE - NOTA DELL'ESPERTO

The two intake manifold gaskets allow the set to be used on several engines.
Le due guarnizioni collettore di aspirazione permettono l'applicazione della serie su più motori.

ENGINES* | MOTORI*

DISPLACEMENT | CILINDRATA

1.0 8V - 1.1 8V - 1.2 8V

CODE | CODICE

141C2.000 - 146C3.000
156A2.000 - 156A2.100 - 156A3.000 - 156A2.048 - 156A2.146 - 156A2.246 - 156A4.048
156C.046 - 156C.000 - 160A3.000
176A6.000 - 176A7.000 - 176A8.000 - 176B1.000 - 176B2.000 - 176B4.000
178B5.000 - 178E2.000

"FIRE" Engines Until 1999 / Motori "FIRE" fino al 1999

MODELS* | MODELLI*

AUTOBIANCHI

Y10 1.0 - 1.1 - 1.2 8V

FIAT

CINQUECENTO 1.1 8V - PALIO 1.2 8V - PANDA - VAN - 4X4 1.0 - 1.1 8V
PUNTO 55 - 65 - 75 1.2 8V - SEICENTO 1.1 8V - SIENA 1.2 MPI 8V - TIPO 1.1 8V
PUNTO 1.1 8V - UNO 45 1.0 8V

LANCIA

Y 1.1 - 1.2 8V

Cylinder head gasket's fire rings with molybdenum sulfide treatment.

Anelli parafiamma della guarnizione testata con trattamento al solfuro di molibdeno.



DESCRIPTION DESCRIZIONE	P/N		CROSS REFERENCES CORRISPONDENZE			
	GA	OE	RNZ	EK	AJ	PY
CYLINDER HEAD GASKET SET, WITH H.G., WITH OIL SEALS KIT GUARNIZIONI TESTATA, CON T.C., CON PARAOLI	051113-7072 ^{^A}	5889375 5892383 5893659 5893661 5893663 + 7696197 (10X)	02-31790-02 02-31790-04 02-31790-07 02-31790-08 + 14-32093-01	144.552 529.471 710.271 710.301 + 760.720	52061100 52089300 52103600 52187900 + 81007600	DV675 + HBS052
CYLINDER HEAD GASKET, COMPOSITE MATERIAL GUARNIZIONE TESTATA IN MATERIALE COMPOSITO	101025-1918	46434102	61-31790-10	710.280	10076500	BV670
CYLINDER HEAD COVER GASKET GUARNIZIONE COPRITESTATA	110584-8100	7688450	71-31734-00	591.076	11008600	JM7156

^{^A} **Unified set with centering dowels and cylinder head bolts - Kit unificato con boccole di centraggio e bulloni testata cilindro**
Cancels and supercedes 051113-1070 - Annulla e sostituisce 051113-1070

051070-1072

CYLINDER HEAD GASKET SET - KIT GUARNIZIONI TESTATA FIAT GROUP



101025-1918



110584-8100

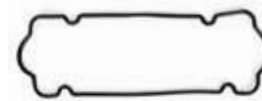

111069-8000

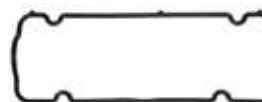

EXPERT'S NOTE - NOTA DELL'ESPERTO

The set contains both items 110584-8100 and 111069-8000
Nel set sono inclusi i codici 110584-8100 e 111069-8000

ENGINES* | MOTORI*

DISPLACEMENT | CILINDRATA

1.2 8V

CODE | CODICE

188A4.000 - 223A5.000

Up to engine / Fino motore : 1890665 - Up to / Fino al 2003

MODELS* | MODELLI*

FIAT
DOBLO* 1.2 8V - NUOVA PANDA VAN 1.2 8V - NUOVA PUNTO 60 1.2 8V
PALIO 1.2 MPI 8V - SIENA 1.2 MPI 8V

LANCIA
Y 1.2 8V

DESCRIPTION DESCRIZIONE	P/N		CROSS REFERENCES CORRISPONDENZE			
	GA	OE	RNZ	EK	AJ	PY
CYLINDER HEAD GASKET SET, WITH H.G., WITH OIL SEALS KIT GUARNIZIONI TESTATA, CON T.C., CON PARAOLI	051070-1072 ^A	71716868	02-31790-05 ^D	180.260	52187700	DV672
CYLINDER HEAD GASKET, COMPOSITE MATERIAL GUARNIZIONE TESTATA IN MATERIALE COMPOSITO	101025-1918	46434102	61-31790-10	710.280	10076500	BV670
CYLINDER HEAD COVER GASKET GUARNIZIONE COPRITESTATA	110584-8100 ^B	7688450	71-31734-00	591.076	11008600	JM7156
CYLINDER HEAD COVER GASKET GUARNIZIONE COPRITESTATA	111069-8000 ^C	46759989	71-35622-00	199.000		JM7159

^A **Set with centering dowels** - Kit con boccole di centraggio

Cancels and supercedes 051070-1000 - Annulla e sostituisce 051070-1000

^B **Until 1999** - Fino al 1999

^C **From 1999** - Dal 1999

^D **With only one valve cover gasket** - Con una sola guarnizione coperchio valvole

051070-7072

CYLINDER HEAD GASKET SET - KIT GUARNIZIONI TESTATA FIAT GROUP

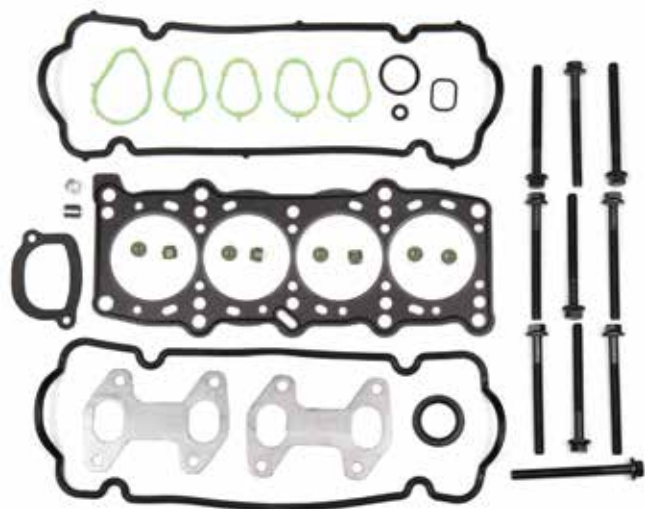

101025-1918



110584-8100

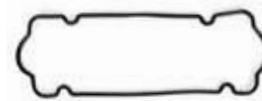

111069-8000

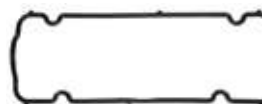

EXPERT'S NOTE - NOTA DELL'ESPERTO

The set contains both items 110584-8100 and 111069-8000
Nel set sono inclusi i codici 110584-8100 e 111069-8000

ENGINES* | MOTORI*

DISPLACEMENT | CILINDRATA

1.2 8V

CODE | CODICE

188A4.000 - 223A5.000

Up to engine / Fino motore: 1890665 - Up to / Fino al 2003

MODELS* | MODELLI*

FIAT

DOBLO' 1.2 8V - NUOVA PANDA - VAN 1.2 8V - NUOVA PUNTO 60 1.2 8V
PALIO 1.2 MPI 8V - SIENA 1.2 MPI 8V -

LANCIA

Y 1.2 8V

DESCRIPTION DESCRIZIONE	P/N	CROSS REFERENCES CORRISPONDENZE				
		GA	OE	RNZ	EK	AJ
CYLINDER HEAD GASKET SET, WITH H.G., WITH OIL SEALS KIT GUARNIZIONI TESTATA, CON T.C., CON PARAOLI	051070-7072 ^A	71716868 + 7696197 (10X)	02-31790-05 ^B + 14-32093-01	180.260 + 760.720	52187700 + 81007600	DV672 + HBS052
CYLINDER HEAD GASKET, COMPOSITE MATERIAL GUARNIZIONE TESTATA IN MATERIALE COMPOSITO	101025-1918	46434102	61-31790-10	710.280	10076500	BV670
CYLINDER HEAD COVER GASKET GUARNIZIONE COPRITESTATA	110584-8100	7688450	71-31734-00	591.076	11008600	JM7156
CYLINDER HEAD COVER GASKET GUARNIZIONE COPRITESTATA	111069-8000	46759989	71-35622-00	199.000		JM7159

^A **Set with centering dowels and cylinder headbolts** - Kit con boccole di centraggio e bulloni testata cilindri
Cancels and supercedes 051070-1070 - Annulla e sostituisce 051070-1070

^B **With only one valve cover gasket** - Con una sola guarnizione coperchio valvole

051139-1072

CYLINDER HEAD GASKET SET - KIT GUARNIZIONI TESTATA FIAT GROUP

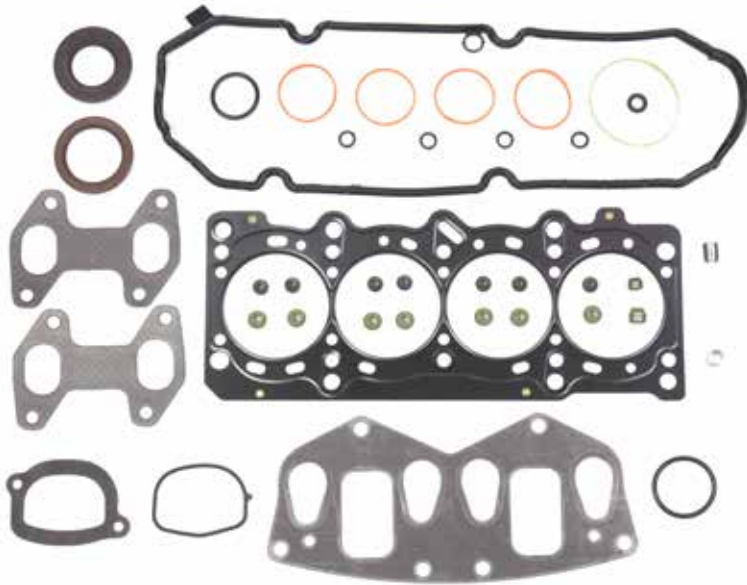

101099-5250



111099-0000



ENGINES* | MOTORI*

DISPLACEMENT | CILINDRATA

1.2 GASOLINE / GAS BIFUEL 8V

CODE | CODICE

188A4.000

MODELS* | MODELLI*

FIAT

NUOVA PANDA (2Q) 1.2 GPL / METANO 8V FROM / DAL 2003 TO / AL 2009
PANDA MY 2009 (3V) 1.2 BZ / METANO 8V FROM / DAL 2009 TO / AL 2010
PUNTO FL'03 (2V) 1.2 BZ / METANO 8V FROM / DAL 2003 TO / AL 2010

DESCRIPTION DESCRIZIONE	P/N		CROSS REFERENCES CORRISPONDENZE			
	GA	OE	RNZ	EK	AJ	PY
CYLINDER HEAD GASKET SET, WITH H.G., WITH OIL SEALS KIT GUARNIZIONI TESTATA, CON T.C., CON PARAOLI	051139-1072 ^A	71745117				
CYLINDER HEAD GASKET, MLS GUARNIZIONE TESTATA, MLS	101099-5250	55183371	61-36900-00	040.554	10175600	AG7380
CYLINDER HEAD COVER GASKET SET KIT GUARNIZIONI COPRITESTATA	111099-0000	71740678	15-37544-01	724.280	56060900	JM7099

^A **Unified set with centering dowels, can be used instead of the current P/N's: 051099-1000 , 051099-1052, 051124-1000, 051124-1052 -**
Kit unificato con boccole di centraggio, puo' essere utilizzato al posto dei correnti codici: 051099-1000 , 051099-1052, 051124-1000, 051124-1052

051139-7072

CYLINDER HEAD GASKET SET - KIT GUARNIZIONI TESTATA FIAT GROUP

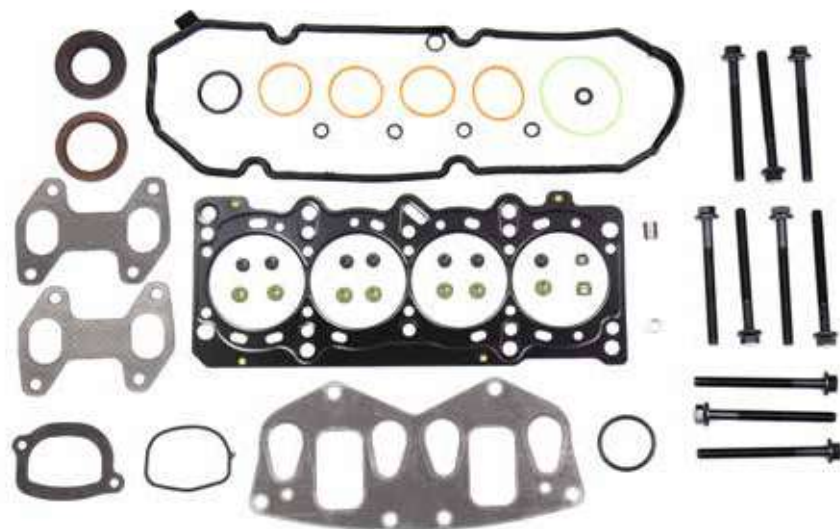

101099-5250



111099-0000



ENGINES* | MOTORI*

DISPLACEMENT | CILINDRATA

1.2 GASOLINE / GAS BIFUEL 8V

CODE | CODICE

188A4.000

MODELS* | MODELLI*

FIAT

NUOVA PANDA (2Q) 1.2 GPL / METANO 8V FROM 2003 TO 2009
PANDA MY 2009 (3V) 1.2 BZ / METANO 8V FROM 2009 TO 2010
PUNTO FL'03 (2V) 1.2 BZ / METANO 8V FROM 2003 TO 2010

DESCRIPTION DESCRIZIONE	P/N		CROSS REFERENCES CORRISPONDENZE			
	GA	OE	RNZ	EK	AJ	PY
CYLINDER HEAD GASKET SET, WITH H.G., WITH OIL SEALS KIT GUARNIZIONI TESTATA, CON T.C., CON PARAOLI	051139-7072 ^A	71745117 + 7696197 (10X)				
CYLINDER HEAD GASKET, MLS GUARNIZIONE TESTATA, MLS	101099-5250	55183371	61-36900-00	040.554	10175600	AG7380
CYLINDER HEAD COVER GASKET SET KIT GUARNIZIONI COPRITESTATA	111099-0000	71740678	15-37544-01	724.280	56060900	JM7099

^A **Unified set with centering dowels and cylinder headbolts, can be used instead of the current P/N's: 051099-1000 , 051099-1052, 051124-1000, 051124-1052** - Kit unificato con boccole di centraggio e bulloni testata cilindro, puo' essere utilizzato al posto dei correnti codici: 051099-1000 , 051099-1052, 051124-1000, 051124-1052

051140-1072

CYLINDER HEAD GASKET SET - KIT GUARNIZIONI TESTATA FIAT GROUP

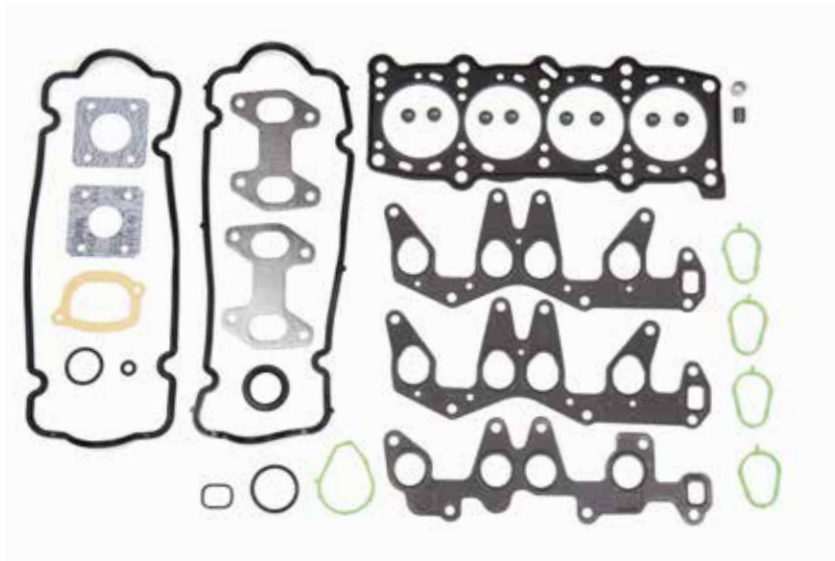

101025-1918



110584-8100



111069-8000



EXPERT'S NOTE - NOTA DELL'ESPERTO

The set contains both items 110584-8100 and 111069-8000
Nel set sono inclusi i codici 110584-8100 e 111069-8000

ENGINES* | MOTORI*

DISPLACEMENT | CILINDRATA

1.0 8V - 1.1 8V - 1.2 8V

CODE | CODICE

141C2.000 - 146C3.000
156A2.000 - 156A2.100 - 156A3.000 - 156A2.048 - 156A2.146 - 156A2.246 - 156A4.048
156C.046 - 156C.000 - 160A3.000
176A6.000 - 176A7.000 - 176A8.000 - 176B1.000 - 176B2.000 - 176B4.000
178B5.000 - 178E2.000
"FIRE" engines until 1999 / Motori "FIRE" Fino al 1999
188A4.000 - 223A5.000
Up to engine / Fino motore : 1890665 - Up to / Fino al 2003

MODELS* | MODELLI*

AUTOBIANCHI

Y10 1.0 - 1.1 - 1.2 8V

FIAT

CINQUECENTO 1.1 8V - DOBLO' 1.2 8V - PALIO 1.2 8V - PALIO 1.2 MPI 8V
PANDA - VAN - 4X4 1.0 - 1.1 8V - NUOVA PANDA - VAN 1.2 8V
PUNTO 1.1 8V - PUNTO 55 - 65 - 75 1.2 8V - NUOVA PUNTO 60 1.2 8V
SEICENTO 1.1 8V - SIENA 1.2 MPI 8V - TIPO 1.1 8V - UNO 45 1.0 8V

LANCIA

Y 1.1 - 1.2 8V

DESCRIPTION DESCRIZIONE	P/N	CROSS REFERENCES CORRISPONDENZE				
		GA	OE	RNZ	EK	AJ
CYLINDER HEAD GASKET SET, WITH H.G., WITH OIL SEALS KIT GUARNIZIONI TESTATA, CON T.C., CON PARAOLI	051140-1072 ^A	5889375 5892383 5893659 5893661 5893663 71716868	02-31790-02 02-31790-04 02-31790-05 02-31790-07 02-31790-08	144.552 180.260 529.471 710.271 710.301	52061100 52089300 52103600 52187700 52187900	DV672 DV675
CYLINDER HEAD GASKET, COMPOSITE MATERIAL GUARNIZIONE TESTATA IN MATERIALE COMPOSITO	101025-1918	46434102	61-31790-10	710.280	10076500	BV670
CYLINDER HEAD COVER GASKET GUARNIZIONE COPRITESTATA	110584-8100 ^B	7688450	71-31734-00	591.076	11008600	JM7156
CYLINDER HEAD COVER GASKET GUARNIZIONE COPRITESTATA	111069-8000 ^C	46759989	71-35622-00	199.000		JM7159

^A **Unified set with centering dowels** - Kit unificato con boccole di centraggio

^B **Until 1999** - Fino al 1999

^C **From 1999** - Dal 1999

051140-7072

CYLINDER HEAD GASKET SET - KIT GUARNIZIONI TESTATA FIAT GROUP

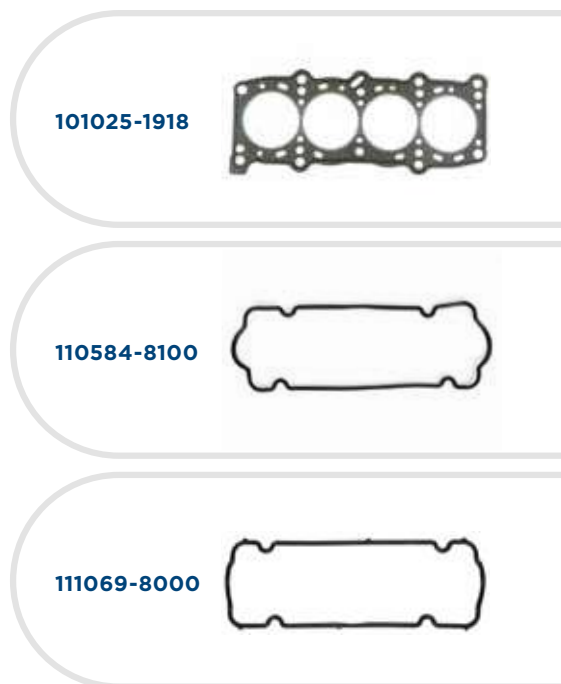

EXPERT'S NOTE - NOTA DELL'ESPERTO
The set contains both items 110584-8100 and 111069-8000
Nel set sono inclusi i codici 110584-8100 e 111069-8000

ENGINES* | MOTORI*

DISPLACEMENT | CILINDRATA

1.0 8V - 1.1 8V - 1.2 8V

CODE | CODICE

141C2.000 - 146C3.000
156A2.000 - 156A2.100 - 156A3.000 - 156A2.048 - 156A2.146 - 156A2.246 - 156A4.048
156C.046 - 156C.000 - 160A3.000
176A6.000 - 176A7.000 - 176A8.000 - 176B1.000 - 176B2.000 - 176B4.000
178B5.000 - 178E2.000
"FIRE" engines until 1999 / Motori "FIRE" fino al 1999
188A4.000 - 223A5.000
Up to engine / Fino motore : 1890665 - Up to / Fino al 2003

MODELS* | MODELLI*

AUTOBIANCHI

Y10 1.0 - 1.1 - 1.2 8V

FIAT

CINQUECENTO 1.1 8V - DOBLO' 1.2 8V - PALIO 1.2 8V - PALIO 1.2 MPI 8V
PANDA - VAN - 4X4 1.0 - 1.1 8V - NUOVA PANDA - VAN 1.2 8V
PUNTO 1.1 8V - PUNTO 55 - 65 - 75 1.2 8V - NUOVA PUNTO 60 1.2 8V
SEICENTO 1.1 8V - SIENA 1.2 MPI 8V - TIPO 1.1 8V - UNO 45 1.0 8V

LANCIA

Y 1.1 - 1.2 8V

DESCRIPTION DESCRIZIONE	P/N		CROSS REFERENCES CORRISPONDENZE			
	GA	OE	RNZ	EK	AJ	PY
CYLINDER HEAD GASKET SET, WITH H.G., WITH OIL SEALS KIT GUARNIZIONI TESTATA, CON T.C., CON PARAOLI	051140-7072 ^A	5889375 5892383 5893659 5893661 5893663 71716868 + 7696197 (10X)	02-31790-02 02-31790-04 02-31790-05 02-31790-07 02-31790-08 + 14-32093-01	144.552 180.260 529.471 710.271 710.301 + 760.720	52061100 52089300 52103600 52187700 52187900 + 81007600	DV672 DV675 + HBS052
CYLINDER HEAD GASKET, COMPOSITE MATERIAL GUARNIZIONE TESTATA IN MATERIALE COMPOSITO	101025-1918	46434102	61-31790-10	710.280	10076500	BV670
CYLINDER HEAD COVER GASKET GUARNIZIONE COPRITESTATA	110584-8100 ^B	7688450	71-31734-00	591.076	11008600	JM7156
CYLINDER HEAD COVER GASKET GUARNIZIONE COPRITESTATA	111069-8000 ^C	46759989	71-35622-00	199.000		JM7159

^A **Unified set with centering dowels and cylinder headbolts** - Kit unificato con boccole di centraggio e bulloni testata cilindro

^B **Until 1999** - Fino al 1999

^C **From 1999** - Dal 1999

051099-1000

FIAT GROUP - FORD - TATA



101099-3850



111099-0000



ENGINES* | MOTORI*

DISPLACEMENT

1.2 8V

1.4 8V

1.2-1.4-1.4 LPG 8V

1.2-1.4-NAT.POWER 8V

—

169A4.000-199A7.000

350A1.000-955A9.000-FP4

ENGINES ECOCF5 - CF6

MODELS* | MODELLI*

ALFA ROMEO

—

MITO 1.4 8V

FIAT

—

DOBLO 1.4 8V - GRANDE PUNTO 1.2-1.4-1.4 LPG 8V - IDEA - LINEA 1.4 8V - N. PANDA 1.2-LPG-1.4 BIPOWER 8V - NUOVA 500 1.2-LPG-N. 500C 1.2 8V - NUOVA PUNTO 1.2 8V - PUNTO EVO 1.2-1.4-NAT.POWER 8V - QUBO 1.4 NATURAL POWER 8V - DOBLO 1.4 8V - FIORINO 1.4 8V

FORD

—

KA 1.2 8V

LANCIA

—

MUSA 1.4-LPG 8V - NUOVA YPSILON 1.2-1.4-LPG 8V

TATA

—

INDICA VISTA-MANZA 1.4 8V

DESCRIPTION	P/N	CROSS REFERENCES				
		OE	RNZ	EK	AJ	PY
HEAD SET WITH MLS H.G. (ORIGINAL PROD.) WITH OIL SEALS	051099-1000	71740655	02-36900-01	037.461	52255600	CG7380
MLS HEAD GASKET (ORIGINAL PROD.)	101099-3850	55183371	61-36900-00	040.554	10175600	AG7380
CYLINDER HEAD COVER WITH 4 RUBBER SEALS	111099-0000	71740678	15-37544-01	724.280	56060900	JM7099

051099-1052

FIAT GROUP - FORD - TATA

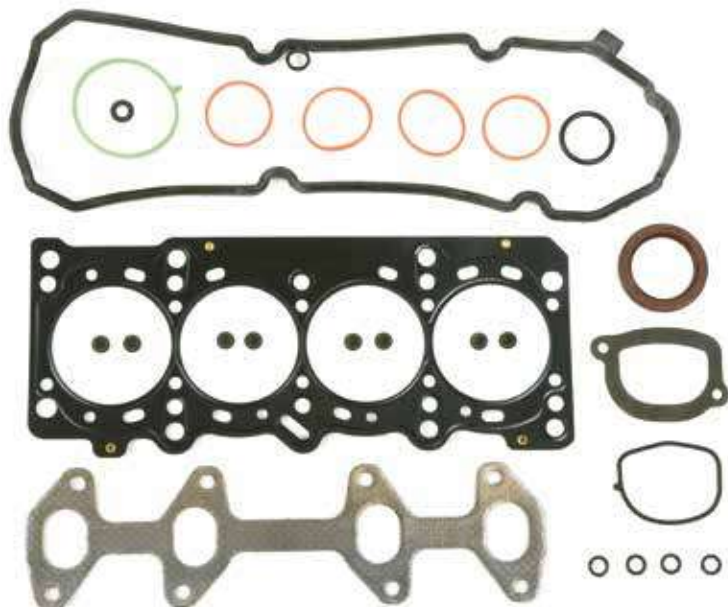

101099-5250



101099-5275



111099-0000



ENGINES* | MOTORI*

DISPLACEMENT
1.2 8V
1.4 8V
1.2-1.4-1.4 LPG 8V
1.2-1.4-NAT.POWER 8V

169A4.000-199A7.000
 350A1.000-955A9.000-FP4
 Engines ECOCF5 - CF6

MODELS* | MODELLI*

ALFA ROMEO
 -
 MITO 1.4 8V

FIAT
 -
 DOBLO 1.4 8V - GRANDE PUNTO 1.2-1.4-1.4 LPG 8V - IDEA - LINEA 1.4 8V - N. PANDA 1.2-LPG-1.4 BIPOWER 8V - NUOVA 500 1.2-LPG-N. 500C 1.2 8V - NUOVA PUNTO 1.2 8V - PUNTO EVO 1.2-1.4-NAT.POWER 8V - QUBO 1.4 NATURAL POWER 8V - DOBLO 1.4 8V - FIORINO 1.4 8V

FORD
 -
 KA 1.2 8V

LANCIA
 -
 MUSA 1.4-LPG 8V - NUOVA YPSILON 1.2-1.4-LPG 8V

TATA
 -
 INDICA VISTA-MANZA 1.4 8V

DESCRIPTION	P/N	CROSS REFERENCES				
		OE	RNZ	EK	AJ	PY
HEAD SET WITH MLS H.G WITH OIL SEALS	051099-1052	71740655	02-36900-01	037.461	52255600	CG7380
MLS HEAD GASKET OUR PRODUCTION	101099-5250	55183371	61-36900-00	040.554	10175600	AG7380
MLS HEAD GASKET OVERSIZED + 0,25 - OUR PRODUCTION	101099-5275 ^					
CYLINDER HEAD COVER WITH 4 RUBBER SEALS	111099-0000	71740678	15-37544-01	724.280	56060900	JM7099

^ Not included in the kit

*Find out our complete range: www.athena.eu | *Per ulteriori informazioni consultate il catalogo online nel nostro sito: www.athena.eu

101099-5275

FIAT GROUP - FORD - TATA



ENGINES* | MOTORI*

DISPLACEMENT
1.2-1.4 8V

169A4.000 - 188A4.000
199A4.000 - 199A7.000
350A1.000-955A9.000-FP4
ENGINES 1.2-1.4 8V FIRE
ECOFC4 - CF5 - CF6

MODELS* | MODELLI*

ALFA ROMEO

MITO

FIAT

GRANDE PUNTO BZ-LPG - IDEA-LINEA-SIENA - N. PANDA BZ-LPG-BIPOWER -
NUOVA 500 BZ-LPG-N. 500C - NUOVA PUNTO - PUNTO EVO BZ-NAT.POWER
- QUBO NPW - DOBLO - FIORINO

FORD

KA

LANCIA

MUSA BZ-LPG - YPSILON - NUOVA YPSILON BZ-LPG

TATA

INDICA VISTA-MANZA

DESCRIPTION	P/N	CROSS REFERENCES				
		OE	RNZ	EK	AJ	PY
MLS HEAD GASKET 0,75 MM. - OUR PRODUCTION	101099-5275 ^A					

^A Increased by 0.25 mm compared to the standard one (0,50 mm), not included in the kit

051124-1000 FIAT GROUP

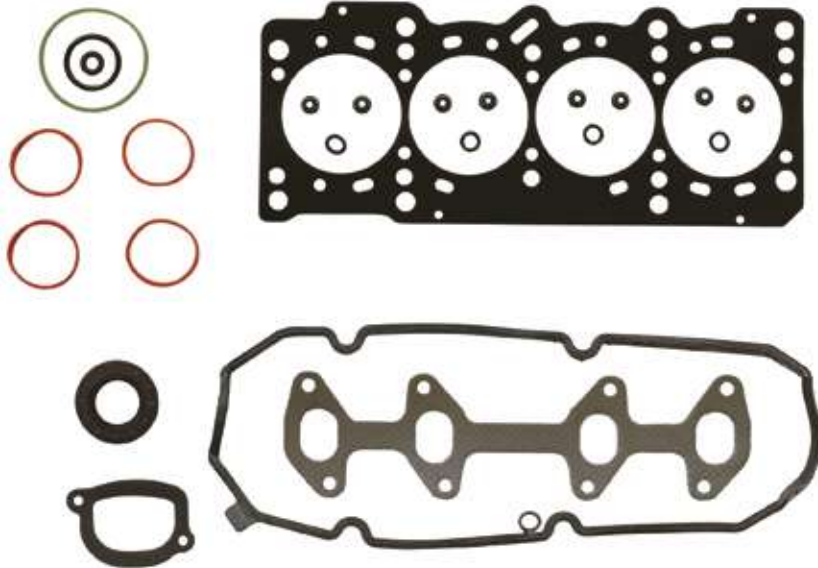

101099-3850



111099-0000



ENGINES* | MOTORI*

DISPLACEMENT

1.2 8V

1.2 LPG 8V

—

188A4.000 DA 2935744

199A4.000

Engines ECOCF4

MODELS* | MODELLI*

FIAT

—

GRANDE PUNTO 2005-2008 1.2 8V - GRANDE PUNTO 2008-2009 1.2 8V -
GRANDE PUNTO ACTUAL 2009-2013 1.2 8V - PUNTO FL'03 2003-2009 1.2-1.2
LPG - NUOVA PUNTO MY2012 1.2 8V - PUNTO MY2013 1.2 8V - PUNTO EVO 2009-
2011 1.2 8V - NUOVA PANDA 2003-2009 1.2 8V - PANDA MY2009 1.2 8V-1.2 LPG
- PANDA MY2011 1.2 8V

LANCIA

—

Y 2003-2011 1.2 8V

DESCRIPTION	P/N	CROSS REFERENCES				
		OE	RNZ	EK	AJ	PY
HEAD SET WITH MLS H.G. (ORIGINAL PROD.) AND OIL SEALS	051124-1000	71741374	02-36330-05	724.330	52255500	CE5242
MLS HEAD GASKET ORIGINAL PROD.	101099-3850	55183371	61-36900-00	040.554	10175600	AG7380
CYLINDER HEAD COVER WITH 4 RUBBER SEALS	111099-0000	71740678	15-37544-01	724.280	56060900	JM7099

*Find out our complete range: www.athena.eu | *Per ulteriori informazioni consultate il catalogo online nel nostro sito: www.athena.eu

051124-1052 FIAT GROUP

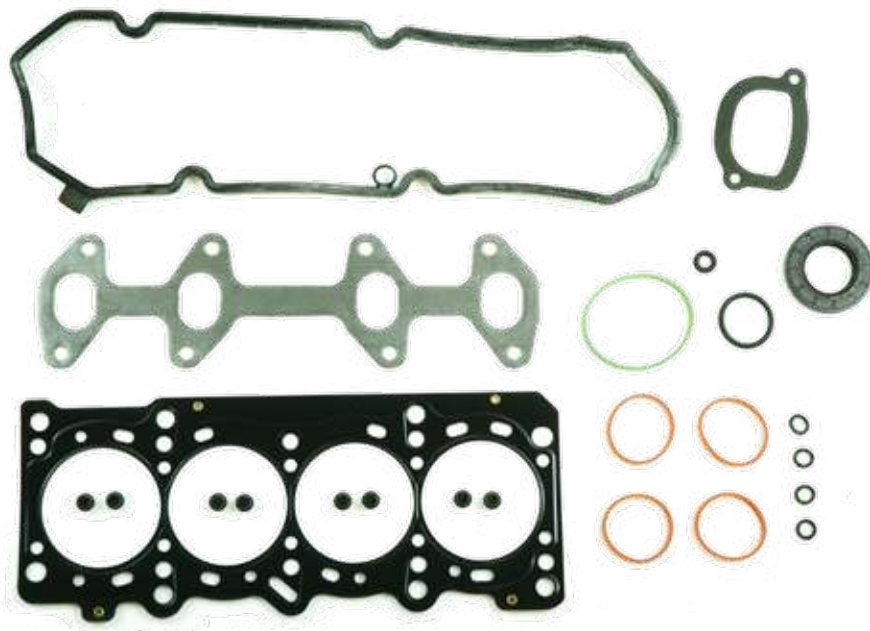

101099-5250



101099-5275



111099-0000



ENGINES* | MOTORI*

DISPLACEMENT

1.2 8V
1.2 LPG 8V

188A4.000 DA 2935744
199A4.000
ENGINES ECOCF4

MODELS* | MODELLI*

FIAT

GRANDE PUNTO 2005-2008 1.2 8V - GRANDE PUNTO 2008-2009 1.2 8V -
GRANDE PUNTO ACTUAL 2009-2013 1.2 8V - PUNTO FL'03 2003-2009 1.2-1.2
LPG - NUOVA PUNTO MY2012 1.2 8V - PUNTO MY2013 1.2 8V - PUNTO EVO 2009-
2011 1.2 8V - NUOVA PANDA 2003-2009 1.2 8V - PANDA MY2009 1.2 8V-1.2 LPG
- PANDA MY2011 1.2 8V

LANCIA

Y 2003-2011 1.2 8V

DESCRIPTION	P/N	CROSS REFERENCES				
		OE	RNZ	EK	AJ	PY
HEAD SET WITH MLS H.G AND OIL SEALS	051124-1052	71741374	02-36330-05	724.330	52255500	CE5242
MLS HEAD GASKET (OUR PRODUCTION)	101099-5250	55183371	61-36900-00	040.554	10175600	AG7380
MLS HEAD GASKET OVERSIZED + 0,25 - OUR PRODUCTION	101099-5275 ^					
CYLINDER HEAD COVER WITH 4 RUBBER SEALS	111099-0000	71740678	15-37544-01	724.280	56060900	JM7099

^ Not included in the kit

053696-1019

FIAT PROFESSIONAL



ENGINES* | MOTORI*

DISPLACEMENT
1.4 8V

—
KFT - KFV
PSA ENGINES
From/Dal 2007 to/al 2010

MODELS* | MODELLI*

FIAT
—
FIORINO 1.4 8V - QUBO 1.4 8V

DESCRIPTION	P/N	CROSS REFERENCES				
		OE	RNZ	EK	AJ	PY
HEAD SET WITH H.G. AND OIL SEALS	053696-1019		02-33715-01		52269700	

*Find out our complete range: www.athena.eu | *Per ulteriori informazioni consultate il catalogo online nel nostro sito: www.athena.eu

051126-1000
FIAT GROUP

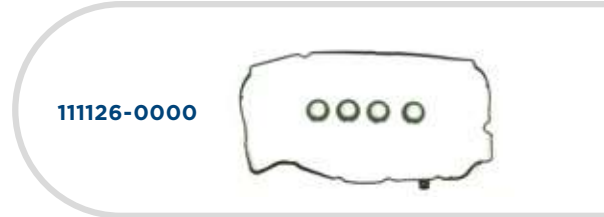
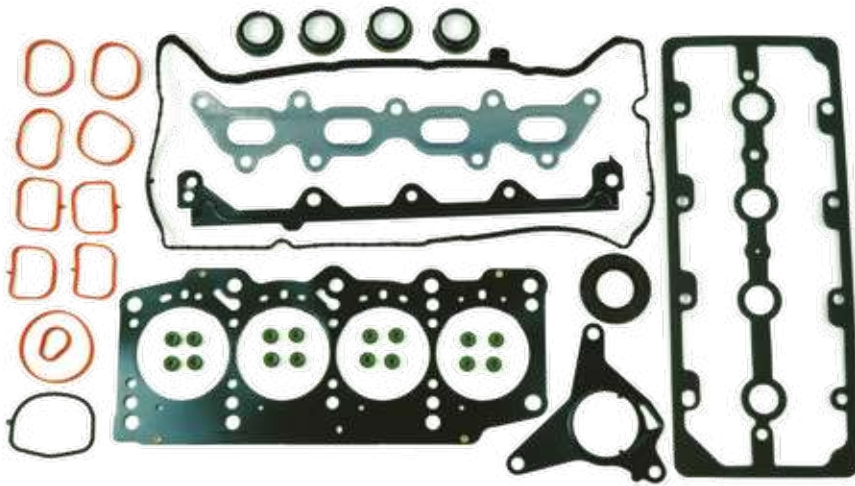

ENGINES* | MOTORI*

DISPLACEMENT
1.4 16V
—
955A6.000
MULTIAIR NATURALLY ASPIRATED
105 HP / 77 KW

MODELS* | MODELLI*

ALFA ROMEO
—
MITO 1.4 16V

FIAT
—
PUNTO EVO 1.4 16V - NUOVA PUNTO MY 2012 1.4 16V - PUNTO MY 2013 1.4 16V

DESCRIPTION	P/N	CROSS REFERENCES				
		OE	RNZ	EK	AJ	PY
HEAD SET WITH MLS H.G. (ORIGINAL PROD.) AND OIL SEALS	051126-1000		02-37110-04		52286100 ^A	
CYLINDER HEAD COVER SET 5 PIECES	111126-0000	55233643 + 55233644	15-42128-01			

^A Without intake manifold kit 71739944

051115-1000

FIAT GROUP - OPEL

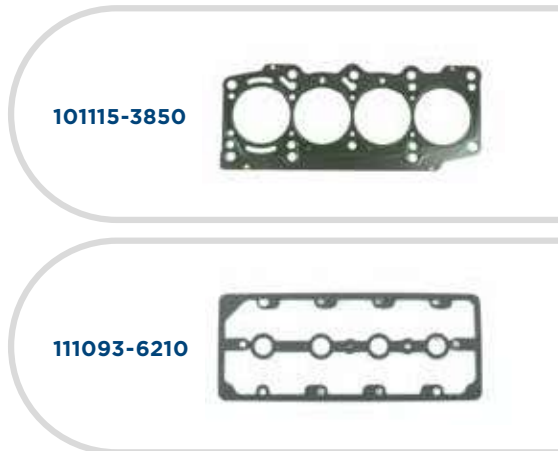

ENGINES* | MOTORI*

DISPLACEMENT
1.4 TB-BIFUEL 16V
1.4 TB 16V
1.4 T-JET 16V
1.4 16V

198A1-A4-A7-A8.000
 199A8.000-940B1-955A8.000
 312A1-A3.000
 A14FC

MODELS* | MODELLI*

ALFA ROMEO

MITO 1.4 TB-BIFUEL 16V - NUOVA GIULIETTA 1.4 TB 16V

FIAT

BRAVO II 1.4 T-JET 16V - DOBLO 1.4 NATURAL POWER 16V - GRANDE PUNTO 1.4 T-JET-ABARTH 16V - LINEA 1.4 T-JET 16V - NUOVA PUNTO 1.4 T-JET 16V - NUOVA 500-C 1.4 ABARTH 16V

LANCIA

DELTA III 1.4 TB-BIFUEL 16V

OPEL

COMBO VAN-TOUR 1.4 16V

DESCRIPTION	P/N	CROSS REFERENCES				
		OE	RNZ	EK	AJ	PY
HEAD SET WITH MLS H.G. (ORIGINAL PROD.). WITH OIL SEALS	051115-1000	71749165	02-38835-01	344.690	52286200	
MLS HEAD GASKET ORIGINAL PROD.	101115-3850	55206232	61-38835-00	344.671	10184500	AH6510
CYLINDER HEAD COVER	111093-6210	55194045	71-35621-10	199.010	11103400	JM5176

*Find out our complete range: www.athena.eu | *Per ulteriori informazioni consultate il catalogo online nel nostro sito: www.athena.eu

051127-1000
FIAT GROUP



ENGINES* | MOTORI*

DISPLACEMENT
1.4 TB 16V

—
198 A7.000 - 199 A8.000 - 955 A2/A7/A8.000

MODELS* | MODELLI*

ALFA ROMEO

—
MITO 1.4 TB MULTIAIR 16V

FIAT

—
PUNTO (MY2012) 1.4 TB MULTIAIR 16V /
PUNTO EVO 1.4 TB / 1.4 ABARTH TB MULTIAIR 16V

LANCIA

—
DELTA III 1.4 TB MULTIAIR 16V

DESCRIPTION	P/N	CROSS REFERENCES				
		OE	RNZ	EK	AJ	PY
HEAD SET WITH MLS H.G. (ORIGINAL PROD.) AND OIL SEALS	051127-1000		02-38835-02		52286400	

051128-1000 FIAT GROUP



101093-3850



111093-6210



ENGINES* | MOTORI*

DISPLACEMENT
1.4 16V
—
192B2.000
843A1.000
From / Dal 05-2006

MODELS* | MODELLI*

FIAT
—
BRAVO II 1.4-1.4 LPG 16V - DOBLO 1.4 16V - IDEA 1.4 16V - NUOVA PUNTO 1.4 16V
- STILO 1.4 16V

LANCIA
—
MUSA 1.4 16V

DESCRIPTION	P/N	CROSS REFERENCES				
		OE	RNZ	EK	AJ	PY
HEAD SET WITH MLS H.G. (ORIGINAL PROD.) AND OIL SEALS	051128-1000	71747638	02-37110-02		52255800	
MLS HEAD GASKET ORIGINAL PROD.	101093-3850	55202800	61-37110-00	344.661	10175800	AG7310
CYLINDER HEAD COVER	111093-6210	55194045	71-35621-10	199.010	11103400	JM5176

*Find out our complete range: www.athena.eu | *Per ulteriori informazioni consultate il catalogo online nel nostro sito: www.athena.eu

051132-1000
FIAT GROUP



ENGINES* | MOTORI*

DISPLACEMENT
1.4 TB 16V

940A2.000 - 940C2.000 - 955A2.000 - EAM

MODELS* | MODELLI*

ALFA ROMEO

GIULIETTA 1.4 TB 16V

FIAT

500 X 1.4 TB 16V

JEEP

RENEGADE 1.4 TB 16V

DESCRIPTION	P/N	CROSS REFERENCES				
		OE	RNZ	EK	AJ	PY
HEAD SET WITH MLS H.G AND OIL SEALS	051132-1000		02-38835-03		52458100	

*Find out our complete range: www.athena.eu | *Per ulteriori informazioni consultate il catalogo online nel nostro sito: www.athena.eu

051130-1000

FIAT GROUP - SUBARU SUZUKI

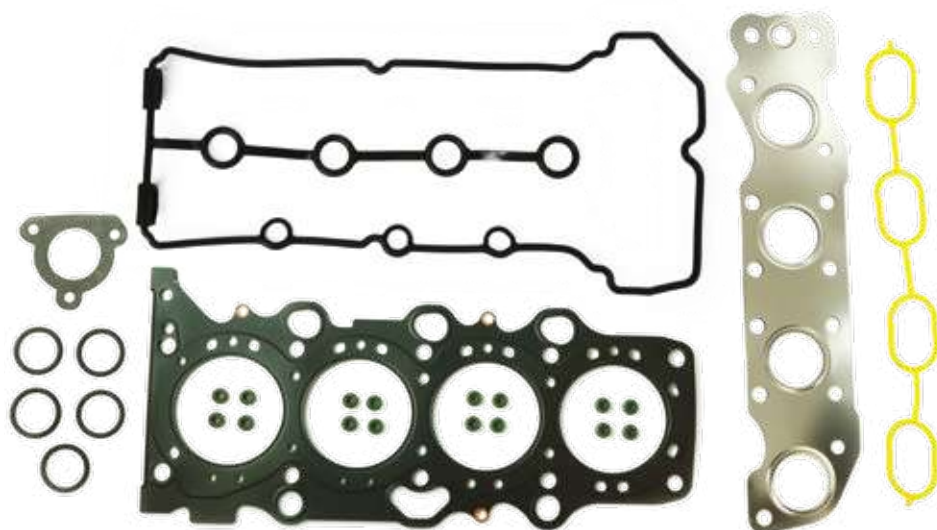

ENGINES* | MOTORI*

DISPLACEMENT
1.3 - 1.5 - 1.6 16V

—
M16A.000 Until / Fino al 2009 (FIAT)
M13A - M13A VVT - M15A

MODELS* | MODELLI*

FIAT

—
SEDICI 1.6 4X4 16V

SUBARU

—
JUSTY II 1.3-1.5 AWD 16V

SUZUKI

—
IGNIS II - JIMNY - WAGON R+2 1.3 4WD

DESCRIPTION	P/N	CROSS REFERENCES				
		OE	RNZ	EK	AJ	PY
HEAD SET WITH MLS H.G	051130-1000	71768054 (FIAT) 11400-86875 (SUZUKI)	02-53640-03	747.340		

*Find out our complete range: www.athena.eu | *Per ulteriori informazioni consultate il catalogo online nel nostro sito: www.athena.eu

051135-1052 **NEW**

CYLINDER HEAD GASKET SET - KIT GUARNIZIONI TESTATA FCA GROUP

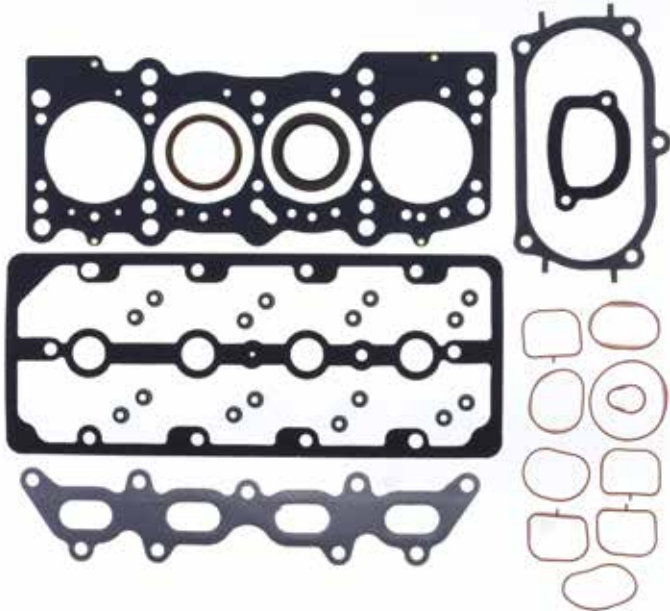

101135-5250



ENGINES* | MOTORI*

DISPLACEMENT | CILINDRATA

1.4 16V

CODE | CODICE

169A3.000 - 192B2.000 - 843A1.000
Up to 2006 / Fino al 2006

MODELS* | MODELLI*

FIAT

IDEA (350) 1.4 16V
PUNTO (188) 1.4 16V
STILO - STILO MULTIWAGON (192) 1.4 16V

LANCIA

MUSA (350) 1.4 16V
YPSILON (843) 1.4 16V

DESCRIPTION DESCRIZIONE	P/N		CROSS REFERENCES CORRISPONDENZE			
	GA	OE	RNZ	EK	AJ	PY
CYLINDER HEAD GASKET SET, WITH H.G., WITH OIL SEALS KIT GUARNIZIONI TESTATA, CON T.C., CON PARAOLI	051135-1052	71771911 EX. 71739945 EX. 71738337 EX. 71732702	02-34940-01		52255700	CG6220
CYLINDER HEAD GASKET, MLS GUARNIZIONE TESTATA, MLS	101135-5250*	55184024 55197283	61-34940-00		10175700	AG6220

***The cylinder head gasket 101135-5250 replaces the previous 101072-5250** - La guarnizione testata 101135-5250 sostituisce la precedente 101072-5250

051136-1000 **NEW**

CYLINDER HEAD GASKET SET - KIT GUARNIZIONI TESTATA FCA GROUP

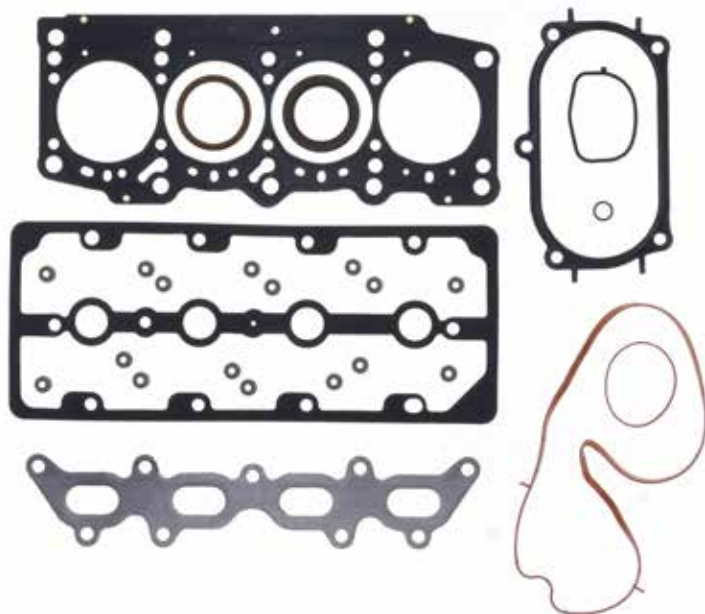

101135-5250



ENGINES* | MOTORI*

DISPLACEMENT | CILINDRATA

1.4 16V

CODE | CODICE

199A6.000 - 955A1.000

MODELS* | MODELLI*

ALFA ROMEO

MITO (955) 1.4 16V (78HP)

FIAT

GRANDE PUNTO (199) 1.4 16V

DESCRIPTION DESCRIZIONE	P/N CROSS REFERENCES CORRISPONDENZE					
	GA	OE	RNZ	EK	AJ	PY
CYLINDER HEAD GASKET SET, WITH H.G., WITH OIL SEALS KIT GUARNIZIONI TESTATA, CON T.C., CON PARAOLI	051136-1000*	71745446	02-37110-06	735.230	52255900	
CYLINDER HEAD GASKET, MLS TH. 0,49 mm GUARNIZIONE TESTATA, MLS SP. 0,49mm	101093-3850	55 202 800	61-37110-00	344.661	10175800	AG7310

*The cylinder head gasket 101135-5250 replaces the previous 101072-5250 - La guarnizione testata 101135-5250 sostituisce la precedente 101072-5250

*Find out our complete range: www.athena.eu | *Per ulteriori informazioni consultate il catalogo online nel nostro sito: www.athena.eu

051131-1000
FIAT GROUP

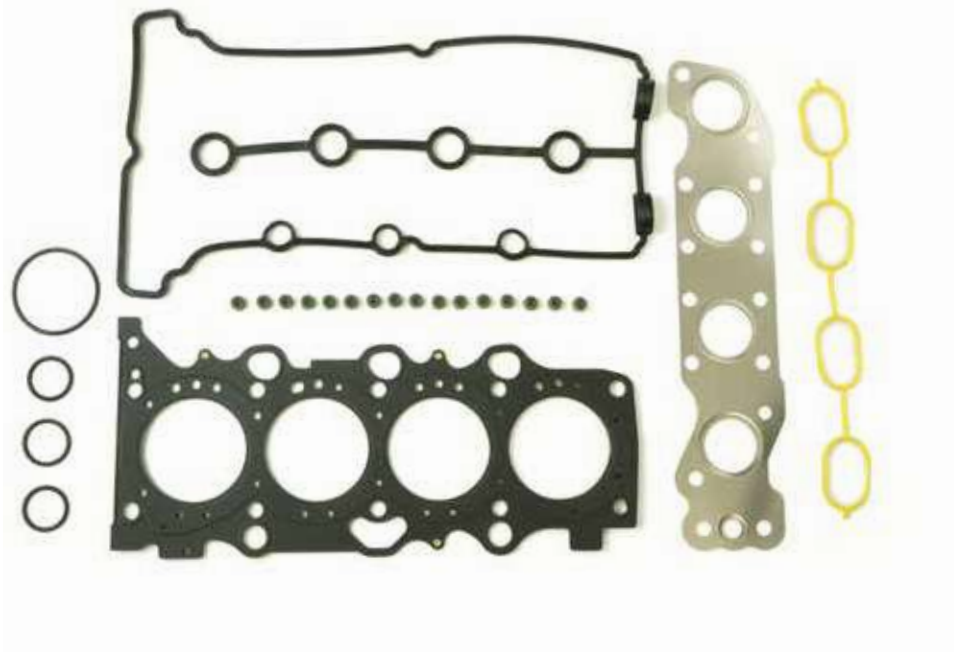

ENGINES* | MOTORI*

DISPLACEMENT
1.6 16V
 —
 M16A.000 From 2009

MODELS* | MODELLI*

FIAT
 —
 SEDICI 1.6 4X4 16V

DESCRIPTION	P/N	CROSS REFERENCES				
		OE	RNZ	EK	AJ	PY
HEAD SET WITH MLS H.G	051131 - 1000	71768119 (FIAT) 11401-54831 (SUZUKI)	02-38245-01			

*Find out our complete range: www.athena.eu | *Per ulteriori informazioni consultate il catalogo online nel nostro sito: www.athena.eu

050254-1000

FIAT GROUP



ENGINES* | MOTORI*

DISPLACEMENT
1.9 - 2.2 JTS 16V

—
939A5.000 - 939A6.000

MODELS* | MODELLI*

ALFA ROMEO

—
159 1.9 JTS 16V - 159 2.2 JTS 16V
BRERA - SPIDER 2.2 JTS 16V

DESCRIPTION	P/N	CROSS REFERENCES				
		OE	RNZ	EK	AJ	PY
HEAD SET WITH MLS H.G. (ORIGINAL PROD.)	050254-1000	71741258	02-38830-01			

*Find out our complete range: www.athena.eu | *Per ulteriori informazioni consultate il catalogo online nel nostro sito: www.athena.eu

041081-1000

FIAT GROUP - OPEL - SUZUKI

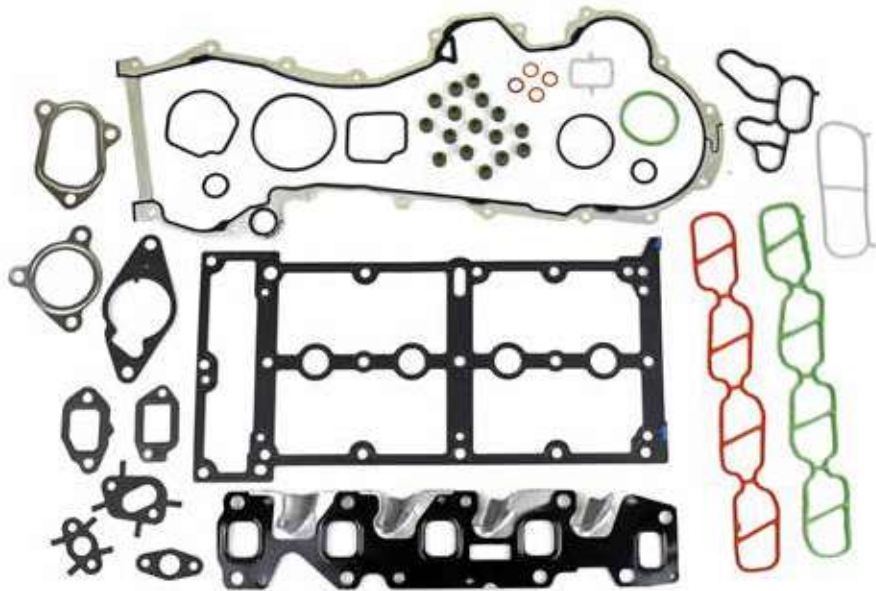

111081-5304

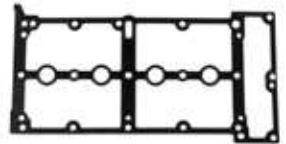

361081-8500

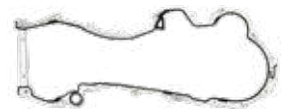

ENGINES* | MOTORI*

**DISPLACEMENT
1.3 MULTIJET 16V**

169A1.000 - 188A9.000 - 199A2/A3.000 - 233A9.000
Z13DT - DTH - DTJ - Y13DT

MODELS* | MODELLI*

FIAT

DOBLO - DOBLO CARGO - IDEA - IDEA CARGO - 1.3 MJTD 16V - GRANDE PUNTO - N. PUNTO - N. PANDA- N. PANDA VAN 1.3 MJTD 16V

LANCIA

MUSA - YPSILON 1.3 MJTD 16V

OPEL

AGILA - ASTRA H - CORSA C - MERIVA - TIGRA 1.3 CDTI 16V - COMBO VAN - CORSA C VAN 1.3 CDTI 16V

SUZUKI

IGNIS II - SWIFT III - WAGON R 1.3 DDiS 16V

DESCRIPTION	P/N	CROSS REFERENCES				
		OE	RNZ	EK	AJ	PY
HEAD SET WITHOUT H.G. AND OIL SEALS	041081-1000	71729499 / 1606458	02-36259-01 / 02-36259-02	431.401 / 655.321	53023500 / 53023600	CD5810
CYLINDER HEAD COVER	111081-5304	73500063 / 5607842	71-36259-00	074.173	11103500	JM5259
TIMING CASE GASKET	361081-8500	55186663 / 646143	71-36261-00	151.550 / 317.170	01096300	KK5646

*Find out our complete range: www.athena.eu | *Per ulteriori informazioni consultate il catalogo online nel nostro sito: www.athena.eu

041121-1000

**CHEVROLET - PSA GROUP
FIAT GROUP - FORD - OPEL
SUZUKI**

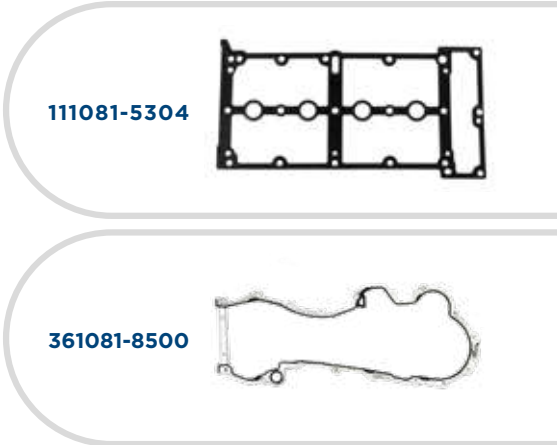
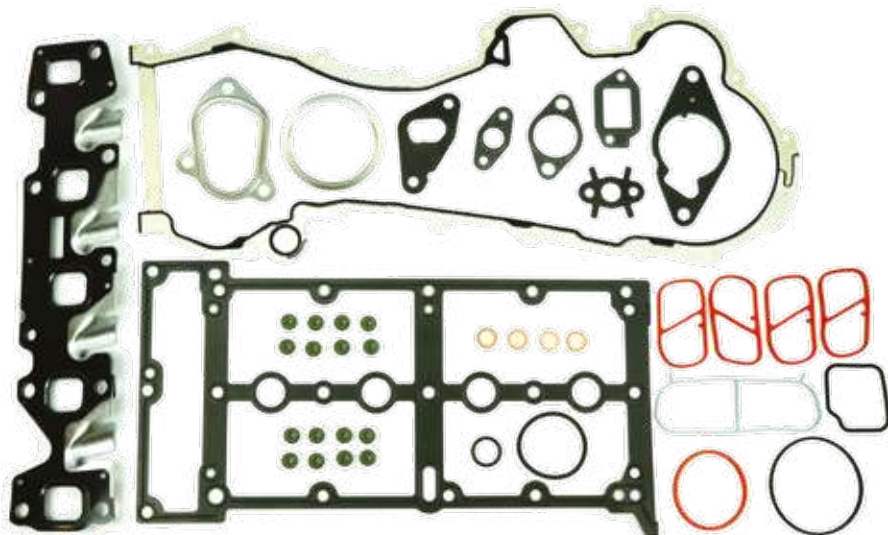

ENGINES* | MOTORI*

**DISPLACEMENT
1.3 MULTIJET 16V**

169A1.000 - 188.A8/A9.000 - 199A2/A3.000 - 199B1/B2.000 - 233A9.000 - A13DH.G. - Z13DT - DTH - DTE - DTJ - Y13DT - D13A - FD4 - FHZ

MODELS* | MODELLI*

ALFA ROMEO

MITO 1.3 JTDM 16V

CHEVROLET

AVEO 1.3 D ID 16V

PSA GROUP

CITROEN NEMO - PEUGEOT BIPPER TEPEE 1.3 HDI 75 16V

FIAT

DOBLO - GRANDE PUNTO - NUOVA 500 - 500C - 500L - 500X 1.3 MJTD 16V - N. PANDA - N. PUNTO - QUBO - SIENA - FIORINO 1.3 MJTD 16V

FORD

KA 1.3 TDCI 16V

LANCIA

MUSA - NEW YPSILON 1.3 MJTD 16V

OPEL

AGILA B - ASTRA J - CORSA D - MERIVA B 1.3 CDTI 16V

SUZUKI

SPLASH - SWIFT IV 1.3 DDiS 16V

DESCRIPTION	P/N	CROSS REFERENCES				
		OE	RNZ	EK	AJ	PY
HEAD SET WITHOUT H.G. AND OIL SEALS	041121-1000	71753908	02-36259-04	789.900	53038900	CD5820
CYLINDER HEAD COVER	111081-5304	73500063 / 5607842	71-36259-00	074.173	11103500	JM5259
TIMING CASE GASKET	361081-8500	55186663 / 646143	71-36261-00	151.550 / 317.170	01096300	KK5646

*Find out our complete range: www.athena.eu | *Per ulteriori informazioni consultate il catalogo online nel nostro sito: www.athena.eu

041081-1051

**CHEVROLET - PSA GROUP
FIAT GROUP - FORD - OPEL
SUZUKI**

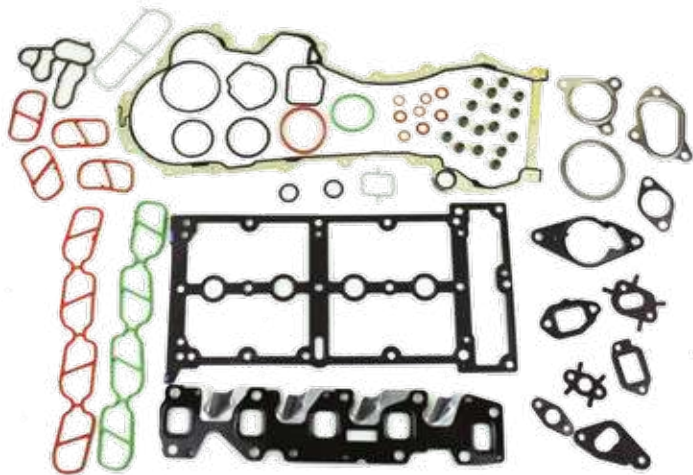

111081-5304

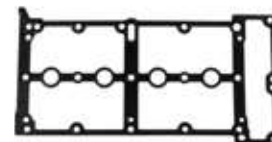

361081-8500



EXPERT'S NOTE - NOTA DELL'ESPERTO

Unified kit, covers all the head sets for Multijet 1.3 engines from 2003 onwards
Kit Unificato, raggruppa tutti i kit smeriglio per motori 1.3 Multijet dal 2003 in poi

ENGINES* | MOTORI*

**DISPLACEMENT
1.3 MULTIJET 16V**

FCA:
169A1.000 - 169A5.000 - 188A8.000 - 188A9.000 - 199A1.000 - 199A2.000 - 199A3.000 -
199A9.000 - 199B1.000 - 199B2.000 - 199B4.000 - 199AB8.000 - 223A9.000 - 263A2.000 -
263A6.000

FORD:
169A1000 - BAAA - FD4

OPEL - CHEVROLET:
A13FD - Z13DTH - LDV - Z13DT

PSA:
FHY - FHZ

MODELS* | MODELLI*

ALFA ROMEO

MITO 1.3 JTDM 16V

CHEVROLET

AVEO 1.3 D ID 16V

PSA GROUP

CITROEN NEMO - PEUGEOT BIPPER TEPEE 1.3 HDI 75 16V

FIAT

DOBLO - GRANDE PUNTO - NUOVA 500 - 500C - 500L - 500X 1.3 MJTD 16V - N. PANDA - N.
PUNTO - QUBO - SIENA - FIORINO 1.3 MJTD 16V

FORD

KA 1.3 TDCI 16V

LANCIA

MUSA - NEW YPSILON 1.3 MJTD 16V

OPEL

AGILA B - ASTRA H- J - CORSA C-D - MERIVA B - TIGRA 1.3 CDTI 16V

SUZUKI

IGNIS II - SPLASH - SWIFT III-IV - WAGON R 1.3 DDiS 16V

DESCRIPTION	P/N	CROSS REFERENCES				
		OE	RNZ	EK	AJ	PY
HEAD SET WITHOUT H.G. AND OIL SEALS (UNIFIED)	041081-1051^A	71744285 / 71738455 / 71744188 / 71753908 / 71729499	02-36259-01 / 02-36259-02 / 02-36259-04 / 02-36259-05	431.401 / 655.321 / 789.900	53023500 / 53023600 / 53038900	CD5810 / CD5820
CYLINDER HEAD COVER	111081-5304	73500063 / 5607842	71-36259-00	074.173	11103500	JM5259
TIMING CASE GASKET	361081-8500	55186663 / 646143	71-36261-00	151.550 / 317.170	01096300	KK5646

^A Unified kit, assembles all the head sets for engines 1.3 multijet from 2003. Can be used instead of p/n 041081-1000 e 041121-1000.

081081-1051

**FIAT GROUP - CHEVROLET - CITROEN
OPEL - SUZUKI - TATA**



ENGINES* | MOTORI*

**DISPLACEMENT
1.3 D 16V (MULTIJET)**

—
188A9.000 - 199A3.000 - 199B1.000 - 233A9.000
A13 DTE - Z13DTH - Z13DTJ

MODELS* | MODELLI*

ALFA ROMEO

—
MITO 1.3 JTDM 16V

FIAT

—
DOBLÒ - GRANDE PUNTO - N.PANDA - N.500 - PUNTO EVO - QUBO 1.3 MJTD 16V

LANCIA

—
Y 1.3 MJTD 16V

OPEL

—
AGILA - ASTRA - CORSA 1.3 CDTI 16V

SUZUKI

—
SWIFT 1.3 DDIS 16V

TATA

—
INDIGO 1.3 ID 16V

DESCRIPTION	P/N	CROSS REFERENCES				
		OE	RNZ	EK	AJ	PY
CRANKCASE GASKET SET - UNIFIED	081081-1051	71736913 71744286 (FIAT) 1606260 (OPEL)	08-36261-01	452.150	54152300	ED5800

*Find out our complete range: www.athena.eu | *Per ulteriori informazioni consultate il catalogo online nel nostro sito: www.athena.eu

101081-5251

**FIAT GROUP - OPEL
PSA GROUP - SUZUKI**



ENGINES* | MOTORI*

**DISPLACEMENT
1.3 JTD - MULTIJET**

169A1.000 - 188A9.000 - 199A3.000 - 199B1.000 etc.
A13DH.G. - DTE - DTH - Y13 DT - Z13 DT-DTJ etc.
FHZ - F13DTE

MODELS* | MODELLI*

ALFA ROMEO

MITO 1.3 JTD

FIAT

N. PANDA - N.PUNTO - GRANDE PUNTO - NUOVA 500 DOBLO - FIORINO 1.3 JTD 16V

OPEL

AGILA - ASTRA H-J - CORSA C-D - MERIVA 1.3 CDTI

CITROEN

NEMO 1.3 HDI

PEUGEOT

BIPPER 1.3 HDI

SUZUKI

IGNIS - SPLASH - SWIFT - WAGON R 1.3 DDiS

DESCRIPTION	P/N	CROSS REFERENCES				
		OE	RNZ	EK	AJ	PY
MLS HEAD GASKET TH. 0,72 MM - 0 NOTCHES	101081-5251^A	55278854	61-36210-00	076.346	10179100	AD5800
MLS HEAD GASKET TH. 0,82 MM - 1 NOTCH	101081-5252^B	55278855	61-36210-10	076.356	10179110	AD5810
MLS HEAD GASKET TH. 0,92 MM - 2 NOTCHES	101081-5253^C	55278856	61-36210-20	076.406	10179120	AD5820

^A Interchangeable with p/n 101081-3851
^B Interchangeable with p/n 101081-3852
^C Interchangeable with p/n 101081-3853

041116-1000

FIAT GROUP - OPEL

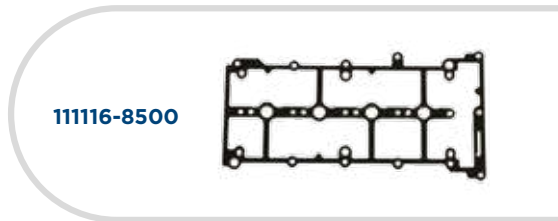
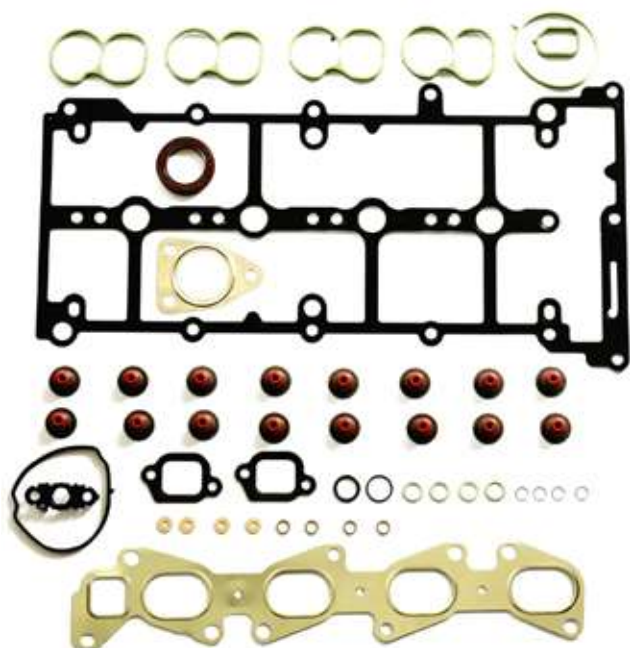

111116-8500

ENGINES* | MOTORI*

DISPLACEMENT
1.6-2.0 JTDM 16V
1.6-2.0 MULTIJET 16V
1.6 D
1.6 CDTI 16V
2.0 JTD
 —
 198A2-A3-A5-A8.000
 939B3-B4-B5.000 - 940A3-A4-A5.000
 944A3.000-955A3-A4.000 etc.

MODELS* | MODELLI*

ALFA ROMEO
 —
 159 - BRERA - SPIDER 2.0 JTDM 16V - MITO 1.6 JTDM 16V
 NUOVA GIULIETTA 1.6-2.0 JTDM 16V

FIAT
 —
 BRAVO II 1.6-2.0 MULTIJET 16V - DOBLO 1.6-2.0 MULTIJET 16V - FREEMONT 2.0
 JTD 4X4 16V - GRANDE PUNTO 1.6 MULTIJET 16V - IDEA - LINEA 1.6 MULTIJET
 16V - NUOVA 500L 1.6 MULTIJET 16V - PUNTO EVO 1.6 MULTIJET 16V - SEDICI
 2.0- 2.0 4X4 MULTIJET 16V

LANCIA
 —
 DELTA III 1.6-2.0 - MUSA 1.6 D

OPEL
 —
 COMBO 1.6 CDTI 16V

DESCRIPTION	P/N	CROSS REFERENCES				
		OE	RNZ	EK	AJ	PY
HEAD SET WITHOUT H.G. WITH OIL SEALS	041116-1000	71753438 71754668 71769851	02-42061-02	399.900	53028300	
CYLINDER HEAD COVER	111116-8500	55205111	71-42061-00	748.591		

*Find out our complete range: www.athena.eu | *Per ulteriori informazioni consultate il catalogo online nel nostro sito: www.athena.eu

081117-1051

FIAT GROUP - OPEL



ENGINES* | MOTORI*

DISPLACEMENT

1.6 -2.0 JTDM - MULTIJET - CDTI 16V

198A2.000 - A3.000 - A5.000 - A6.000 - A8.000 - 263A3.000-A4.000
 350A2.000 - A3.000 - 844A2.000 - A3.000 - 939B3.000 - B4.000
 940A3.000 - C1.000 - C5.000 - 944A3.000 - 955A4.000
 A16FDL - A16FDH - A20FD

MODELS* | MODELLI*

ALFA ROMEO

159 - BRERA 2.0 JTDM 16V- GIULIETTA 1.6 JTDM 16V

FIAT

BRAVO II - DOBLO 1.6-2.0 MULTIJET 16V

LANCIA

DELTA III 1.6-2.0 MULTIJET 16V - MUSA 1.6 MULTIJET 16V

OPEL

COMBO 1.6-2.0 CDTI 16V

DESCRIPTION	P/N	CROSS REFERENCES				
		OE	RNZ	EK	AJ	PY
CRANKCASE GASKET SET	081117-1051	71749743 (FIAT) 95512439 (OPEL)	08-36278-03		54161800	

With rear integrated crankshaft oil seal p/n 997001-8300

*Find out our complete range: www.athena.eu | *Per ulteriori informazioni consultate il catalogo online nel nostro sito: www.athena.eu

101116-5251

FIAT GROUP - OPEL - SUZUKI



ENGINES* | MOTORI*

DISPLACEMENT
1598 - 1956 CC JTDM 16V

198A2-A3-A6.000 - 199B5.000 - 263A3-A4-A5-A7000 - 350A2-A3.000 - 55260384
- 844A3.000 - 940A3-C1-C5.000 - 944A3.000 - 955A3-A4.000 - EJJ - EJK - A16FDM -
FDL - D16AA

MODELS* | MODELLI*

ALFA ROMEO

MITO - NUOVA GIULIETTA 1.6 JTDM 16V

FIAT

BRAVO II - DOBLO' 1.6-2.0 D MULTIJET 16V - GRANDE PUNTO - LINEA 1.6 D MULTIJET
16V - 500L - 500X - PUNTO EVO 1.6 D MULTIJET 16V

JEEP

COMPASS - RENEGADE 1.6 CRD 16V

LANCIA

DELTA III - MUSA 1.6 D 16V

OPEL

COMBO 1.6 CDTI 16V

SUZUKI

SX4 S-CROSS - VITARA 1.6 DDIS 16V

DESCRIPTION	P/N	CROSS REFERENCES				
		OE	RNZ	EK	AJ	PY
MLS HEAD GASKET 0,82 MM 0 HOLES	101116-5251 ^A	55221093	61-38200-00	789.180	10184600	AH6880
MLS HEAD GASKET 0,92 MM 1 HOLE	101116-5252 ^B	55221094	61-38200-10	789.190	10184610	AH6890
MLS HEAD GASKET 1,02 MM 2 HOLES	101116-5253 ^C	55221095	61-38200-20	789.200	10184620	AH6900

^A Interchangeable with p/n 101116-3851

^B Interchangeable with p/n 101116-3852

^C Interchangeable with p/n 101116-3853

101074-5251

FIAT GROUP



ENGINES* | MOTORI*

DISPLACEMENT
1.9 DS

188A3.000 - 223A6.000 From/Dal 1999 to/al 2003

MODELS* | MODELLI*

FIAT

DOBLO' 1.9 DS CF3 - NUOVA PUNTO 60 1.9 DS CF2-CF3 - PALIO W.E. 1.9 DS CF3 - PROFESSIONAL DOBLO' CARGO 1.9 DS CF3 - STRADA 1.9 DS CF3

DESCRIPTION	P/N	CROSS REFERENCES				
		OE	RNZ	EK	AJ	PY
MLS HEAD GASKET TH. 0,8 MM - 0 NOTCHES	101074-5251 ^A	46529117	61-35630-00	028.020	10123800	BZ791
MLS HEAD GASKET TH. 0,9 MM - 1 NOTCH	101074-5252 ^B	46529118	61-35630-10	028.030	10123810	BZ801
MLS HEAD GASKET TH. 1 MM - 2 NOTCHES	101074-5253 ^C	46529119	61-35630-20	028.040	10123820	BZ811

^A Cancels and supercedes p/n 101074-3851

^B Cancels and supercedes p/n 101074-3852

^C Cancels and supercedes p/n 101074-3853

101075-5251

FIAT GROUP - OPEL - SAAB SUZUKI

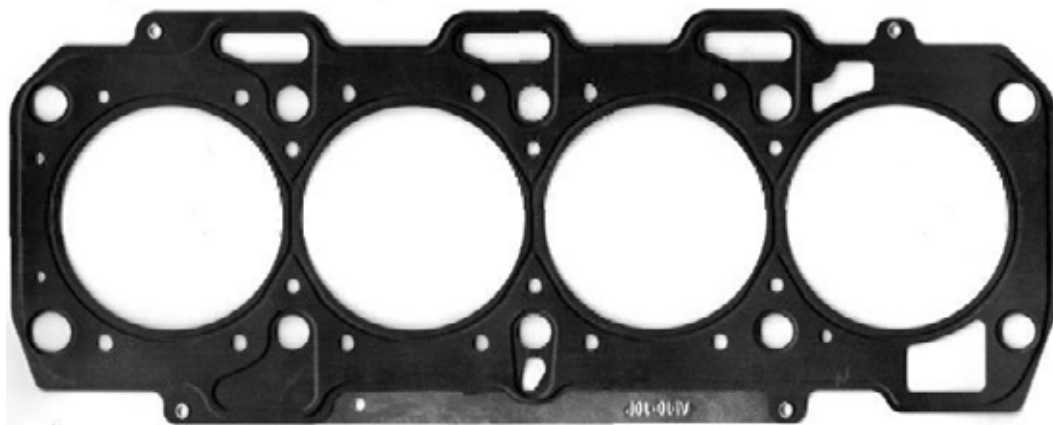

ENGINES* | MOTORI*

DISPLACEMENT
1.9 JTD 8V

AR 37101 - 182B9.000 - 186A6-A8-A9.000 - 188A2-A7-B2.000 ETC. - 192A1-A3.B4.000-199A5.000-223A7-B1-B2.000-939A1-A5.000 ETC. - D19AA - Z19DT - DTL

MODELS* | MODELLI*

ALFA ROMEO

147 - 156 - 159 1.9 JTD 8V CF2

FIAT

BRAVA - BRAVO - DOBLO - GRANDE PUNTO - IDEA 1.9 JTD 8V CF3 - MAREA - MULTIPLA - N.PUNTO - N.CROMA - PALIO 1.9 JTD 8V CF3 - SEDICI - STILO - MARENGO - STRADA

LANCIA

MUSA 1.9 JTD 8V CF3

OPEL

ASTRA H - SIGNUM - VECTRA C - ZAFIRA B 1.9 CDTI 8V

SAAB

9-3 1.9 TID 8V

SUZUKI

SX4 (RW419D) 1.9 DDIS 8V

DESCRIPTION	P/N	CROSS REFERENCES				
		OE	RNZ	EK	AJ	PY
MLS HEAD GASKET 0,82 MM	101075-5251 ^A	46749904 / 55190356 / 5607632	61-35580-00	217.001	10123900	AG7390
MLS HEAD GASKET 0,92 MM 1 NOTCH	101075-5252 ^B	55202010 / 5607845 / 93189405	61-35580-10	217.021	10123910	AG7400
MLS HEAD GASKET 1,02 MM 2 NOTCHES	101075-5253 ^C	55202011 - 5607847	61-35580-20	217.031	10123920	AG7440

^A Interchangeable with p/n 101075-3851

^B Interchangeable with p/n 101075-3852

^C Interchangeable with p/n 101075-3853

081118-1051

FIAT GROUP - OPEL



ENGINES* | MOTORI*

DISPLACEMENT
1.9 MULTIJET 8V - 16V

199A5.000 - 937A8.000 - 939A1.000 - A2.000 - A7.000 - A8.000
D19AA - Z19DT - DTL

MODELS* | MODELLI*

ALFA ROMEO

159 1.9 JTDM 8V - 1.9 JTDM 16V

FIAT

GRANDE PUNTO - N. CROMA - SEDICI 1.9 MULTIJET 8V -
N. CROMA 1.9 MULTIJET 16V

OPEL

ASTRA H 1.9 CDTI 8V

DESCRIPTION	P/N	CROSS REFERENCES				
		OE	RNZ	EK	AJ	PY
CRANKCASE GASKET SET	081118-1051	71740083-4 (FIAT) 1606336 (OPEL)	08-36278-01 - 08-38308-01			

With rear integrated crankshaft oil seal p/n 997001-8300

051524-1000

FORD

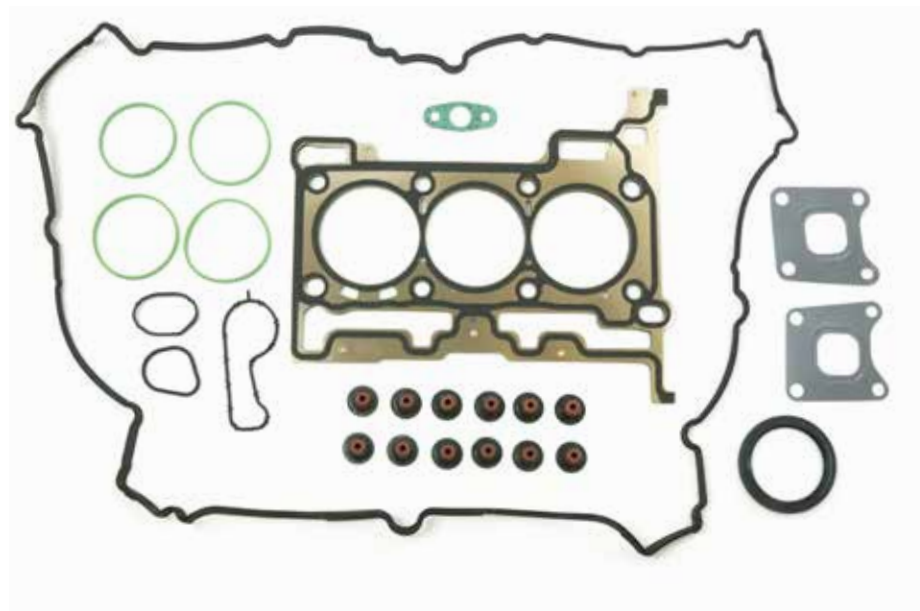

ENGINES* | MOTORI*

DISPLACEMENT
1.0 12V ECOBOOST

MICA - CB - DA - DC - ETC. - M2DA - DB - DC ETC. - P4JA - JB - JC - JD - SFCA - CB - CC ETC. - XMJA - JB - JC - JD

MODELS* | MODELLI*

FORD

B-MAX (JK) - C-MAX II - GRAND C-MAX (DXA/CB7) 1.0 ECOBOOST 12V - ECOSPORT - FIESTA VI 1.0 ST 12V - FOCUS III 1.0 ECOBOOST 12V - MONDEO V (BA7) 1.6 ECOBOOST 12V - TRANSIT - TOURNEO COURIER 1.0 ECOBOOST 12V - TOURNEO - GRAND TOURNEO CONNECT 1.0 ECOBOOST 12V

DESCRIPTION	P/N	CROSS REFERENCES				
		OE	RNZ	EK	AJ	PY
HEAD SET WITH H.G.	051524-1000		02-43170-01		50333700	
MLS HEAD GASKET TH. 0,7 MM	101524-5250	1771609	61-43170-00	650.420	10207200	
CYLINDER HEAD COVER	111524-8000	1761118 / 1799829	71-42373-00		11131800	

*Find out our complete range: www.athena.eu | *Per ulteriori informazioni consultate il catalogo online nel nostro sito: www.athena.eu

081524-9970

CRANKCASE GASKET SET - KIT GUARNIZIONI MONOBLOCCO FORD



ENGINES* | MOTORI*

DISPLACEMENT | CILINDRATA

1.0 12V

CODE | CODICE

MICA - M1CB - M1DA - M1DC - M1DD - M1JA - M1JC - M1JE - M1JH - M1JJ - M1JL - M1JM
- M1JP - M1JU - M2DA - M2DB - M2DC - M2GA - M2GB - P4JA - P4JB - P4JC - P4JD
- SFCA - SFCB - SFCC - SFCD - SFDA - SFDB - SFJA - SFJB - SFJC - SFJD - SFJE -
SFJF - SFJH - SFJJ - SFJK - SFJL - SFJN - SFJP - XMJA - XMJB - XMJC - XMJD - YYJA
- YYJB - YYJC - YYJD - YYJE

MODELS* | MODELLI*

FORD

B-MAX - B-MAX VAN 1.0 12V ECOBOOST
C-MAX II - C-MAX II VAN 1.0 12V ECOBOOST
GRAND C-MAX - GRAND C-MAX VAN 1.0 12V ECOBOOST
ECOSPORT 1.0 12V ECOBOOST
FIESTA VI 1.0 12V ECOBOOST - FIESTA VII 1.0 12V VAN ECOBOOST
FOCUS III 1.0 12V ECOBOOST
MONDEO V - MONDEO V TURNIER 1.0 12V ECOBOOST
TRANSIT CONNECT 1.0 12V ECOBOOST
TRANSIT COURIER 1.0 12V ECOBOOST
TOURNEO CONNECT - GRAND TOURNEO CONNECT 1.0 12V ECOBOOST

DESCRIPTION DESCRIZIONE	P/N		CROSS REFERENCES CORRISPONDENZE			
	GA	OE	RNZ	EK	AJ	PY
CRANKCASE GASKET SET KIT GUARNIZIONI MONOBLOCCO	081524-9970		08-42892-01		54192200	

051538-1052

NEW

CYLINDER HEAD GASKET SET - KIT GUARNIZIONI TESTATA FORD

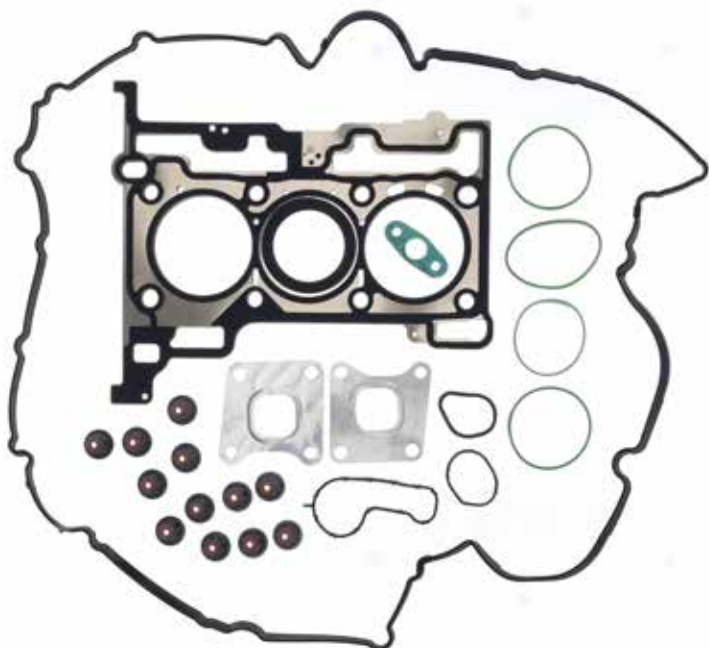

101538-5250



111524-8000

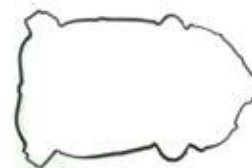

ENGINES* | MOTORI*

DISPLACEMENT | CILINDRATA

1.0 12V

CODE | CODICE

YYJA - YYJB - YYJC - YYJD - YYJE

MODELS* | MODELLI*

FORD

B-MAX (JK) 1.0 ECOBOOST 12V (02.2016-)
ECOSPORT 1.0 ECOBOOST 12V (03.2016-)
FIESTA VI (CBI-CCN) 1.0 SPORT 12V
FIESTA VII 1.0 ECOBOOST 12V

DESCRIPTION DESCRIZIONE	P/N		CROSS REFERENCES CORRISPONDENZE			
	GA	OE	RNZ	EK	AJ	PY
CYLINDER HEAD GASKET SET, WITH H.G., WITH OIL SEALS KIT GUARNIZIONI TESTATA, CON T.C., CON PARAOLI	051538-1052		02-10224-01		52447100	
CYLINDER HEAD GASKET, MLS GUARNIZIONE TESTATA, MLS	101538-5250	1857022 CM5G6051LA	61-10224-00		10222900	
CYLINDER HEAD COVER GASKET GUARNIZIONE COPRITESTATA	111524-8000*	1761118 1799829 CM5G 6K260 EB CM5G 6K260 EA	71-42373-00	696.080	11131800	

*The cylinder head cover gasket covers all 1.0 EcoBoost engines from 2012 onwards. All the applications are available on TecDoc - La guarnizione copritestata monta tutti i motori 1.0 EcoBoost dal 2012 in poi. Tutte le applicazioni sono disponibili su TecDoc

*Find out our complete range: www.athena.eu | *Per ulteriori informazioni consultate il catalogo online nel nostro sito: www.athena.eu

052582-1000
FORD - MAZDA

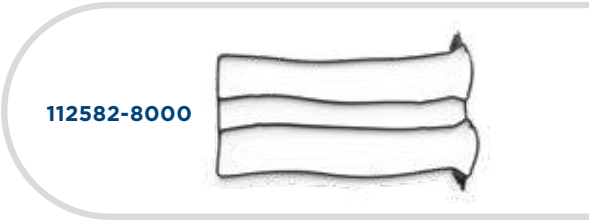
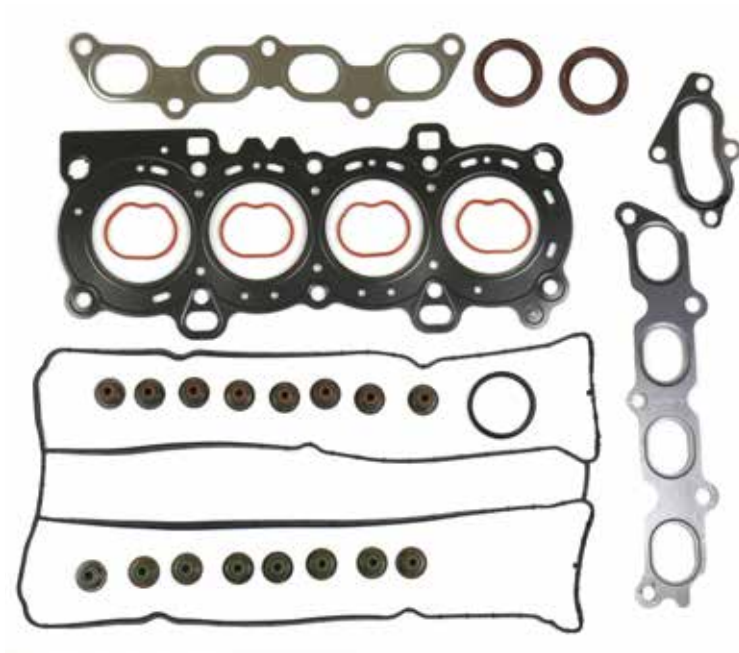

ENGINES* | MOTORI*

DISPLACEMENT
1.25 16V
—
DURATEC 16V SFI
FUJA - FUJB
M7JA - M7JB

MODELS* | MODELLI*

FORD
—
FIESTA V (JH-JD) 1.25 16V - FUSION (JU) 1.25 16V
MAZDA
—
2 (DY) 1.25 16V

DESCRIPTION	P/N	CROSS REFERENCES				
		OE	RNZ	EK	AJ	PY
HEAD SET WITH MLS H.G AND OIL SEALS	052582-1000		02-34295-02 + 71-38086-00	024.961 + 761.031	52217700	
MLS HEAD GASKET	102582-5250	1229474 (FORD) C201-10-271A (MAZDA)	61-34295-00	125.022	10156400	AG8310
CYLINDER HEAD COVER (FOR PLASTIC COVER)	112582-8000	1141575	71-38086-00	761.031	11096200	JM5155

*Find out our complete range: www.athena.eu | *Per ulteriori informazioni consultate il catalogo online nel nostro sito: www.athena.eu

051521-1000

FORD

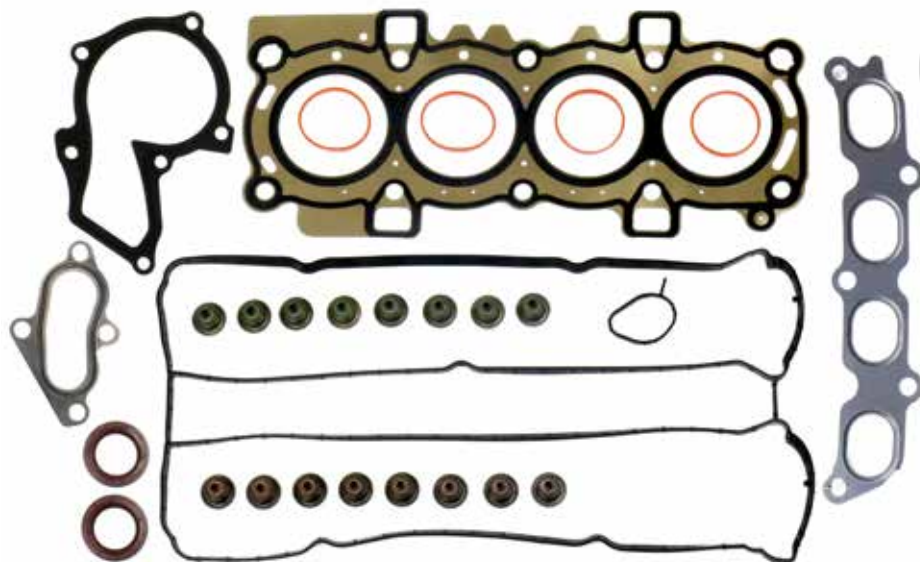

101521-5250



ENGINES* | MOTORI*

DISPLACEMENT
1.25 16V
—
STJA -B - SNJA -B

MODELS* | MODELLI*

FORD
—
FIESTA VI - FIESTA VAN 1.25 16V

DESCRIPTION	P/N	CROSS REFERENCES				
		OE	RNZ	EK	AJ	PY
HEAD SET WITH MLS H.G AND OIL SEALS	051521-1000		02-36930-01	790.620	52368700	
MLS HEAD GASKET	101521-5250	1538349	61-36930-00	457.531	10186100	

*Find out our complete range: www.athena.eu | *Per ulteriori informazioni consultate il catalogo online nel nostro sito: www.athena.eu

051515-1051

FORD



102597-5250



112582-8000

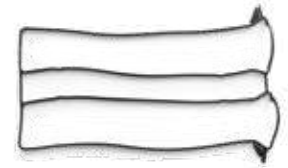

ENGINES* | MOTORI*

DISPLACEMENT
1.4 16V
—
DURATEC 16V SFI
ASDA - ASDB

MODELS* | MODELLI*

FORD
—
FOCUS II 1.4 16V - FOCUS II SW 1.4 16V

DESCRIPTION	P/N	CROSS REFERENCES				
		OE	RNZ	EK	AJ	PY
HEAD SET WITH MLS H.G AND OIL SEALS - UNIFIED	051515-1051		02-36400-02 + 71-38086-00	388.961	52270400	
MLS HEAD GASKET	102597-5250	1253984	61-36400-00	255.040	10156500	
CYLINDER HEAD COVER (FOR PLASTIC COVER)	112582-8000	1141575	71-38086-00	761.031	11096200	JM5155

*Find out our complete range: www.athena.eu | *Per ulteriori informazioni consultate il catalogo online nel nostro sito: www.athena.eu

051522-1000

FORD

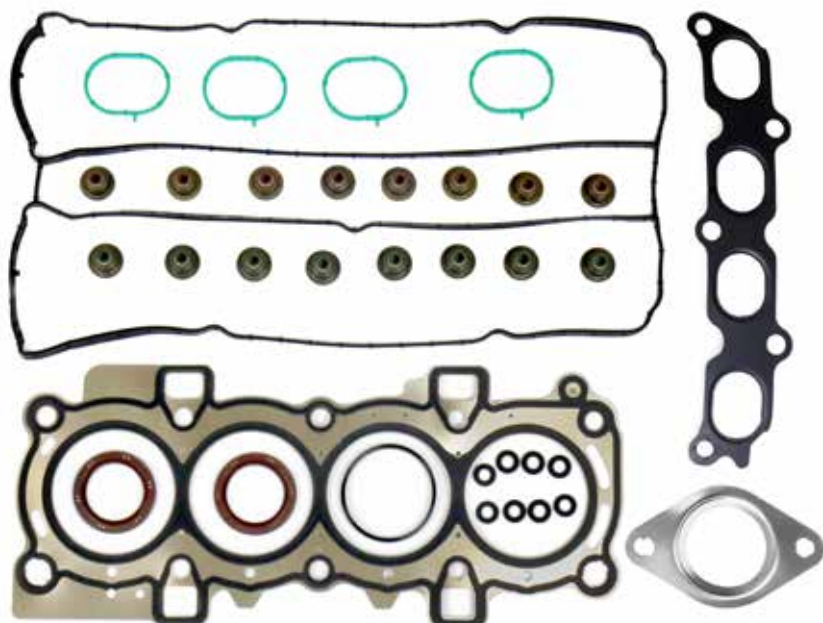

101522-5250



ENGINES* | MOTORI*

DISPLACEMENT
1.4 16V
—
SPJA - C - RTJA -B

MODELS* | MODELLI*

FORD
—
FIESTA VI 1.4 16V - LPG 16V

DESCRIPTION	P/N	CROSS REFERENCES				
		OE	RNZ	EK	AJ	PY
HEAD SET WITH MLS H.G AND OIL SEALS	051522-1000		02-36925-01	191.640	52270300	
MLS HEAD GASKET	101522-5250	1538348	61-36925-00	457.551	10186200	

*Find out our complete range: www.athena.eu | *Per ulteriori informazioni consultate il catalogo online nel nostro sito: www.athena.eu

052590-1000

FORD



102590-5250



112579-8000

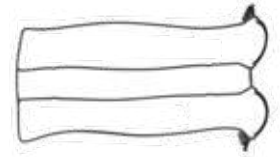

ENGINES* | MOTORI*

DISPLACEMENT
1.6i 16V
—
ZETEC-SE

MODELS* | MODELLI*

FORD
—
FIESTA IV SPORT 1.6i 16V - FOCUS 1.6i 16V

DESCRIPTION	P/N	CROSS REFERENCES				
		OE	RNZ	EK	AJ	PY
HEAD SET WITH MLS H.G AND OIL SEALS	052590-1000		02-31730-04+ 71-33846-00		52158800	
MLS HEAD GASKET	102590-5250	1097083	61-31730-00	013.920	10118600	AC5860
CYLINDER HEAD COVER (FOR ALUMINUM COVER)	112579-8000	1072160	71-33846-00	389.110	11060600	JM7060

*Find out our complete range: www.athena.eu | *Per ulteriori informazioni consultate il catalogo online nel nostro sito: www.athena.eu

052599-1000

FORD



102590-5250



112582-8000



ENGINES* | MOTORI*

DISPLACEMENT
1.6i 16V

ZETEC SE SFI
FYDA - FYDB - FYDC
FYDD - FYDH

MODELS* | MODELLI*

FORD

FOCUS 1.6i 16V (DAW-DBW-DFW) - FOCUS SW 1.6i 16V (DNW)

DESCRIPTION	P/N	CROSS REFERENCES				
		OE	RNZ	EK	AJ	PY
HEAD SET WITH MLS H.G AND OIL SEALS	052599-1000		02-31730-04+ 71-38086-00	434.300+761.031	52218100	CG9560
MLS HEAD GASKET	102590-5250	1097083	61-31730-00	013.920	10118600	AC5860
CYLINDER HEAD COVER (FOR PLASTIC COVER)	112582-8000	1141575	71-38086-00	761.031	11096200	JM5155

*Find out our complete range: www.athena.eu | *Per ulteriori informazioni consultate il catalogo online nel nostro sito: www.athena.eu

051512-1000

FORD - MAZDA - VOLVO

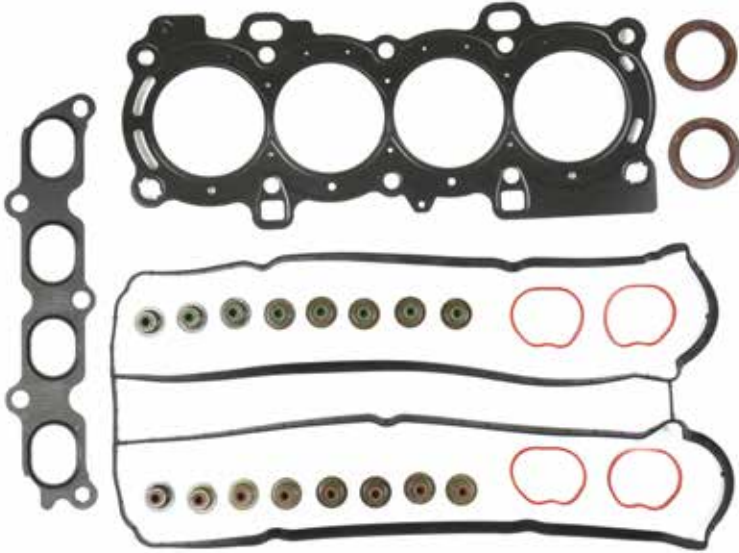

101512-5250



112582-8000



ENGINES* | MOTORI*

**DISPLACEMENT
1.6 16V**

—
ZETEC SE SFI
DURATEC 16V SFI
FYDA-DB-DC-DD-DH - FYJA-FYJB
HWDA-HWDB-SHDA-SHDB-C
B4164S3 (VOLVO)

MODELS* | MODELLI*

FORD

—
FIESTA V 1.6 16V (JD-JH) - FOCUS I 1.6 16V (DAW-DBW) - FOCUS II 1.6 16V (DFW-DNW) - FOCUS SW 1.6 16V (DA) - FOCUS C-MAX 1.6 16V - FUSION 1.6i 16V (JU)

MAZDA

—
2 1.6 16V

VOLVO

—
C30 1.6 16V - S40 II 1.6 16V (MS) - V50 1.6 16V (MW)

DESCRIPTION	P/N	CROSS REFERENCES				
		OE	RNZ	EK	AJ	PY
HEAD SET WITH MLS H.G AND OIL SEALS	051512-1000		02-35930-02+ 71-38086-00	569.871+ 255.050+ 761.031	52264200	
MLS HEAD GASKET	101512-5250	1305949	61-35930-00	255.050	10156600	AG9560
CYLINDER HEAD COVER (FOR PLASTIC COVER)	112582-8000	1141575	71-38086-00	761.031	11096200	JM5155

*Find out our complete range: www.athena.eu | *Per ulteriori informazioni consultate il catalogo online nel nostro sito: www.athena.eu

051514-1000

FORD



101514-5250



111514-8000

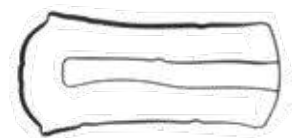

ENGINES* | MOTORI*

DISPLACEMENT
1.6 TI 16V

—
HXDA - HXDB - SIDA
Until/Fino al 2007

MODELS* | MODELLI*

FORD

—
FOCUS C-MAX 1.6 TI 16V (DM2) - FOCUS II 1.6 TI 16V (DA) - FOCUS II SW 1.6 TI (DA)

DESCRIPTION	P/N	CROSS REFERENCES				
		OE	RNZ	EK	AJ	PY
HEAD SET WITH MLS H.G AND OIL SEALS	051514-1000		02-36020-01	569.970 226.400	52270700	CH5680
MLS HEAD GASKET	101514-5250	1319733	61-36020-00	007.820	10181900	AH5680
CYLINDER HEAD COVER	111514-8000	1319177	71-36659-00	010.051	11113900	JM7092

*Find out our complete range: www.athena.eu | *Per ulteriori informazioni consultate il catalogo online nel nostro sito: www.athena.eu

051523-1000

FORD



101523-5250



111514-8000

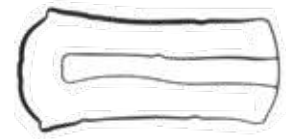

ENGINES* | MOTORI*

DISPLACEMENT
1.6 Ti-Flexifuel 16V

—
HXDA HXDB DAL 2007
HXJA-B-IQDA-B-KGBA-PNBA
PNDA-RHBA-U5JA-XTDA

MODELS* | MODELLI*

FORD

—
C-MAX II 1.6 Ti-Flexifuel 16V - FIESTA VI 1.6 TI 16V - FOCUS III 1.6-1.6Ti 16V -
FOCUS III 1.6-Ti Flexifuel 16V - FOCUS III Turnier 1.6 TI 16V - FOCUS III Turnier 1.6
LPG 16V - GRAND C-MAX 1.6 TI 16V - MONDEO IV 1.6 TI 16V - MONDEO IV 1.6
Turnier 16V

DESCRIPTION	P/N	CROSS REFERENCES				
		OE	RNZ	EK	AJ	PY
HEAD SET WITH MLS H.G AND OIL SEALS	051523-1000		02-37575-01	226.400	52270700	CH6430
MLS HEAD GASKET	101523-5250	1471557	61-37575-00	362.832	10186400	AH6430
CYLINDER HEAD COVER	111514-8000	1319177	71-36659-00	010.051	11113900	JM7092

*Find out our complete range: www.athena.eu | *Per ulteriori informazioni consultate il catalogo online nel nostro sito: www.athena.eu

102566-5250

FORD



ENGINES* | MOTORI*

DISPLACEMENT
1.6 8V

—
CDB - CDC - CDRA - CDRB

MODELS* | MODELLI*

FORD

—
KA - STREET KA 1.6

DESCRIPTION	P/N	CROSS REFERENCES				
		OE	RNZ	EK	AJ	PY
MLS HEAD GASKET	102566-5250	1099084	61-36635-00	024.999	10154200	AC5890

*Find out our complete range: www.athena.eu | *Per ulteriori informazioni consultate il catalogo online nel nostro sito: www.athena.eu

051525-1000

CYLINDER HEAD GASKET SET - KIT GUARNIZIONI TESTATA FORD

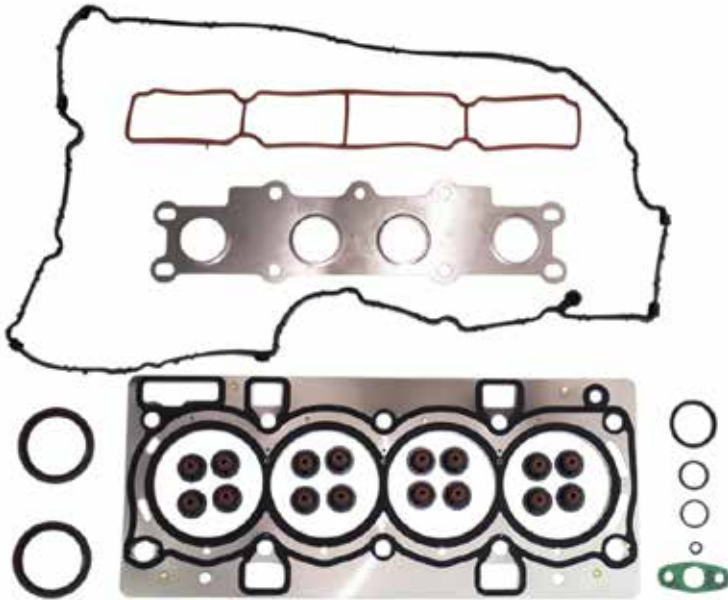

101525-5250



111525-8100



ENGINES* | MOTORI*

DISPLACEMENT | CILINDRATA

1.6 16V

CODE | CODICE

JQDA - JQDB - JQGA - JQMA - JQMB - JTBA - JTBB - JTDA - JTDB - JTJA - JTJB - JTJC - JTMA - JTWA - JTWB - YUDA - B4164 T - B4164 T2 - B4164 T3

MODELS* | MODELLI*

FORD

C-MAX II - GRAND C-MAX 1.6 ECOBOOST 16V
 FIESTA VI 1.6 ST-ST200 16V
 FOCUS III 1.6 ECOBOOST-FLEXIFUEL 16V
 GALAXY - KUGA II 1.6 ECOBOOST 16V
 MONDEO IV - S-MAX 1.6 ECOBOOST 16V
 TRANSIT CONNECT -1.6 ECOBOOST 16V
 TOURNEO - GRAND TOURNEO CONNECT 1.6 ECOBOOST 16V

VOLVO

S60 II T3-T4-T4F - S80 II T4-T4F 1.6 16V
 V40 T3-T4 GTDI - V60 T3-T4-T4F - V70 III T4-T4F 1.6 16V

DESCRIPTION DESCRIZIONE	P/N		CROSS REFERENCES CORRISPONDENZE			
	GA	OE	RNZ	EK	AJ	PY
CYLINDER HEAD GASKET SET, WITH H.G., WITH OIL SEALS KIT GUARNIZIONI TESTATA, CON T.C., CON PARAOLIO	051525-1000		02-37985-01		52415900	
CYLINDER HEAD GASKET MLS GUARNIZIONE TESTATA MLS	101525-5250	1685734 31460680	61-10236-00		10206700	AH7860
CYLINDER HEAD COVER GASKET GUARNIZIONE COPRITESTATA	111525-8100	1704081 31330772	71-37727-00	318.170	11131400	JM7213

*Find out our complete range: www.athena.eu | *Per ulteriori informazioni consultate il catalogo online nel nostro sito: www.athena.eu

101525-5250

FORD - VOLVO



ENGINES* | MOTORI*

DISPLACEMENT
1.6 16V ECOBOOST

—
JQDA - DB - GA - MA - MB - JTBA - BB - DA - DB - JA - JB
B4164T - T2 - T3 - T4

MODELS* | MODELLI*

FORD

—
C-MAX II - GRAND C-MAX (DXA/CB7) 1.6 ECOBOOST 16V - FIESTA VI 1.6 ST 16V
- FOCUS III 1.6 ECOBOOST-FLEXIFUEL 16V - GALAXY 1.6 ECOBOOST 16V - KUGA
II (DM2) - MONDEO IV (BA7) - S-MAX (WA6) 1.6 ECOBOOST 16V - TRANSIT
CONNECT - TOURNEO - GRAND TOURNEO 1.6 ECOBOOST 16V

VOLVO

—
S60 II (134) T3-T4-T4F - S80 II (124) T4-T4F 1.6 16V - V40 (525-6) T2-T3-T4 - V60
(155) T3-T4-T4F - V70 III (135) T4-T4F 1.6 16V

DESCRIPTION	P/N	CROSS REFERENCES				
		OE	RNZ	EK	AJ	PY
MLS HEAD GASKET	101525-5250	1685734 / 1849263 / 31330400	61-10236-00		10206700	AH7860

*Find out our complete range: www.athena.eu | *Per ulteriori informazioni consultate il catalogo online nel nostro sito: www.athena.eu

042588-1051

FORD

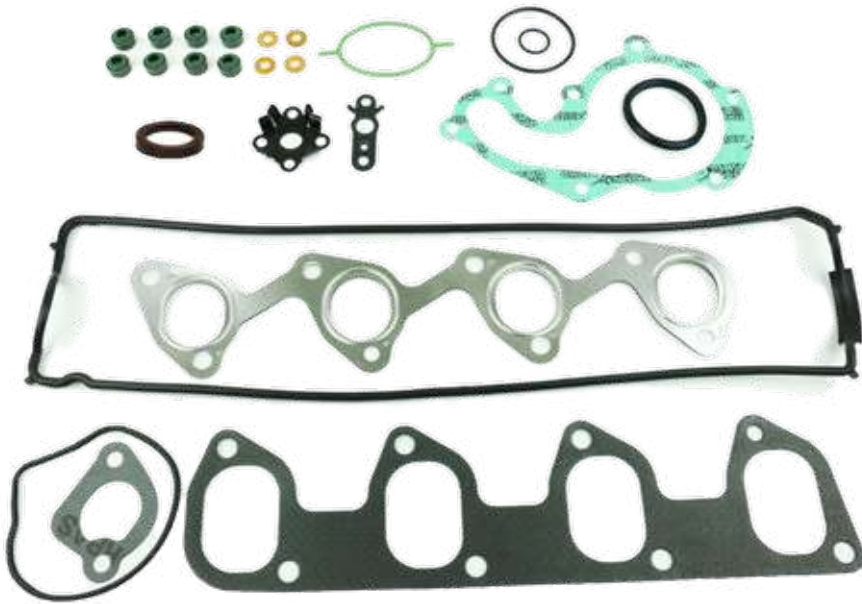

ENGINES* | MOTORI*

DISPLACEMENT
1.8 DI - TDCI- TDDI 8V
 —
 BHDA - BHDB - BHPA
 C9DA - C9DB - C9DC
 F9DA - F9DB - FFDA
 HCPA - HCPB

MODELS* | MODELLI*

FORD
 —
 FIESTA IV 1.8 TDDI 8V - FOCUS 1.8 DI - TDCI- TDDI 8V - MONDEO II 1.8 TD 8V
FORD COMMERCIALI
 —
 TRANSIT CONNECT 1.8 DI-TDCI

DESCRIPTION	P/N	CROSS REFERENCES				
		OE	RNZ	EK	AJ	PY
HEAD SET WITHOUT H.G. WITH OIL SEALS	042588-1051 ^A		02-34112-02	030.492	53010100	DZ720
CYLINDER HEAD COVER	112588-8000	1078524	71-34112-00	027.570	11074500	JM5016

^A Cancels and supercedes p/n 042588-1000

082588-1000

FORD



ENGINES* | MOTORI*

DISPLACEMENT
1.8 TDCI 8V
1.8 TD DI 8V
1.8 TD 8V
1.8 DI 8V

—
 BHDA-BHDB-BHPA
 C9DA-C9DB-C9DC
 F9DA-F9DB-FFBA-FFDA-FFWA
 HCPA-HCPB-KHBA-KKDA-KKDB
 P7PA-B-P9PA-B-C-D
 QYBA-QYWA
 R2-R3PA-RTN-P-Q-RWPA-C-D-E-F

MODELS* | MODELLI*

FORD
 —
 C-MAX 1.8 TDCI 8V - FIESTA IV 1.8 TD DI 8V - FOCUS 1.8 DI - TDCI- TDDI 8V
 - FOCUS C-MAX 1.8 TDCI 8V - FOCUS II 1.8 TDCI 8V - GALAXY 1.8 TDCI 8V -
 MONDEO II 1.8 TD 8V - MONDEO IV 1.8 TDCI 8V - S-MAX 1.8 TDCI 8V

FORD COMMERCIALI
 —
 TOURNEO CONNECT 1.8 DI 8V - TRANSIT CONNECT 1.8 DI-TDCI

DESCRIPTION	P/N	CROSS REFERENCES				
		OE	RNZ	EK	AJ	PY
CRANKCASE GASKET SET UNIFIED	082588-1000		08-34327-01	030.460 030.500 ^A	54158400 54088700 54159100 ^B	EZ720
OIL SUMP	162588-8500	1078498	71-34327-00	027.330	14075000	JH5008

^A IOS 527.410 Oil Seal not included

^B IOS seals not included

042564-1051

FORD

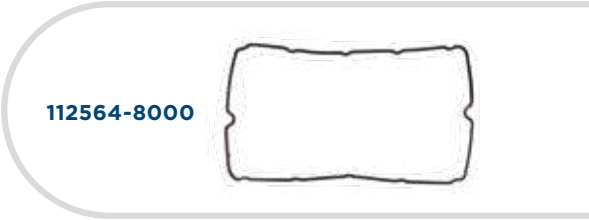
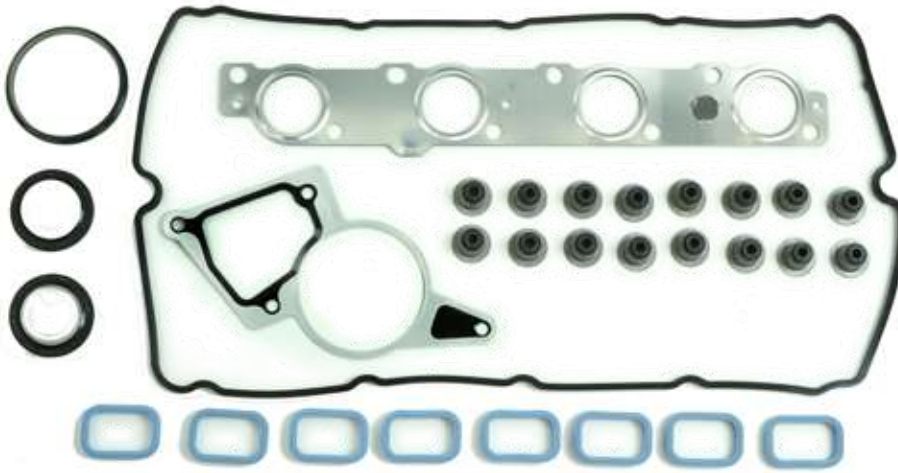

ENGINES* | MOTORI*

DISPLACEMENT
2.0 TDCI - TDDI - DI 16V
 —
 ABFA
 D3FA-D5BA-D6BA
 F3FA-FMBA
 Until/Fino a 05.2002

MODELS* | MODELLI*

FORD
 —
 MONDEO III 2.0 TDDI 16V - MONDEO III 2.0 TDCI 16V - MONDEO III 2.0 DI 16V
FORD COMMERCIALI
 —
 TRANSIT BUS 2.0 DI 16V 75-86-100 CV - TRANSIT 2.0 DI 16V 75-86-100 CV

DESCRIPTION	P/N	CROSS REFERENCES				
		OE	RNZ	EK	AJ	PY
HEAD SET WITHOUT H.G. WITH OIL SEALS	042564-1051 ^A		02-33758-01	030.612	53014600	
CYLINDER HEAD COVER	112564-8000	1198000	71-35115-00	027.720	11088000	

^A Cancels and supercedes p/n 042564-1000, With vacuum pump gaskets

042565-1051

FORD

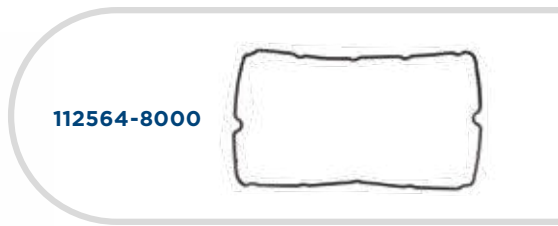

ENGINES* | MOTORI*

DISPLACEMENT
2.0 TDCI - TDDI - DI 16V
 —
 ABFA
 D3FA-D5BA-D6BA
 F3FA
 HJBA-BB-BC
 N7BA
 SDBA
 DAL 2002

MODELS* | MODELLI*

FORD
 —
 MONDEO III 2.0 TDDI 16V - MONDEO III 2.0 TDCI 16V - MONDEO III 2.0 DI 16V
 MANUAL TRANSMISSION
FORD COMMERCIALI
 —
 TRANSIT BUS 2.0 DI 16V 75-86-100 CV - TRANSIT 2.0 DI 16V 75-86-100 CV

DESCRIPTION	P/N	CROSS REFERENCES				
		OE	RNZ	EK	AJ	PY
HEAD SET WITHOUT H.G. WITH OIL SEALS	042565-1051 ^A		02-33758-02 / 02-33758-03	030.652	53018400- 53018600	
CYLINDER HEAD COVER	112564-8000	1198000	71-35115-00	027.720	11088000	

^A Cancels and supercedes p/n 042565-1000, With vacuum pump gaskets and exhaust manifold gasket with heat shield

*Find out our complete range: www.athena.eu | *Per ulteriori informazioni consultate il catalogo online nel nostro sito: www.athena.eu

041530-1099

FORD



112564-8000



ENGINES* | MOTORI*

DISPLACEMENT

2.0 TDDI 16V

2.0 TDCI 16V

2.2 TDCI 16V

—

FIFA-FMBA

HJBA-BB

QJBA-BB-BC-BD (2.2)

MODELS* | MODELLI*

FORD

—

MONDEO III 2.0 TDDI 16V - MONDEO III 2.0 TDCI 16V - MONDEO III 2.2 TDCI 16V -
AUTOMATIC TRANSMISSION

FORD COMMERCIALI

—

TRANSIT BUS 2.0 TDCI 16V 125 CV - TRANSIT 2.0 TDCI 16V 125 CV

DESCRIPTION	P/N	CROSS REFERENCES				
		OE	RNZ	EK	AJ	PY
HEAD SET WITHOUT H.G. WITH OIL SEALS	041530-1099 ^A		02-33758-04	030.602	53029400	
CYLINDER HEAD COVER GASKET	112564-8000	1198000	71-35115-00	027.720	11088000	

^A With vacuum pump gaskets and exhaust manifold gasket with heat shield

041529-1099

FORD



ENGINES* | MOTORI*

DISPLACEMENT
2.2 TDCI 16V
 —
 PBFA-FB-PGFA-FB
 QVFA-QWFA
 SRFA-FB-FC-FD-FE

MODELS* | MODELLI*

FORD
 —
 TRANSIT BUS 2.2 TDCI 16V 85-110 CV
 TRANSIT BUS 2.2 TDCI 16V 115-130 CV
 TRANSIT BUS 2.2 TDCI 16V 140 CV
 TRANSIT 2.2 TDCI 16V 85-110-115 CV
 TRANSIT 2.2 TDCI 16V 130-140 CV
 TRANSIT TOURNEO 2.2 TDCI 16V 110 CV
 TRANSIT TOURNEO 2.2 TDCI 16V 115 CV
 TRANSIT TOURNEO 2.2 TDCI 16V 130 CV
 TRANSIT TOURNEO 2.2 TDCI 16V 140 CV

DESCRIPTION	P/N	CROSS REFERENCES				
		OE	RNZ	EK	AJ	PY
HEAD SET WITHOUT H.G. WITH OIL SEALS	041529-1099 ^A		02-35115-03	052.090	53030300	
CYLINDER HEAD COVER	112564-8000	1198000	71-35115-00	027.720	11088000	

^A With vacuum pump gaskets and exhaust manifold gasket with heat shield

102564-5251

FORD



ENGINES* | MOTORI*

DISPLACEMENT

2.0 TDDI 16V

2.0 TDCI 16V

2.0 DI 16V

2.2 TDCI 16V

—

ABFA-D3FA-D5BA-D6BA

F3FA-FIFA-FMBA

HJBA-BB-BC-N7BA-SDBA

QJBA-BB-BC-BD (2.2)

MODELS* | MODELLI*

FORD

—

MONDEO III 2.0 TDDI 16V - MONDEO III 2.0 TDCI 16V - MONDEO III 2.0 DI 16V -
MANUAL TRANSMISSION -
MONDEO III 2.0 TDDI 16V - MONDEO III 2.0 TDCI 16V - MONDEO III 2.2 TDCI 16V -
AUTOMATIC TRANSMISSION

FORD COMMERCIALI

—

TRANSIT BUS 2.0 DI 16V 75-86-100 CV - TRANSIT 2.0 DI 16V 75-86-100 CV -
TRANSIT BUS 2.0 TDCI 16V 125 CV - TRANSIT 2.0 TDCI 16V 125 CV

DESCRIPTION	P/N	CROSS REFERENCES				
		OE	RNZ	EK	AJ	PY
MLS HEAD GASKET TH. 1,1 MM 1 HOLE	102564-5251 ^A	1120389 1250940 1349880	61-35425-00	265.371	10138300	AA5970
MLS HEAD GASKET TH. 1,15 MM 2 HOLES	102564-5252 ^B	1120390 1250941 1349890	61-35425-10	265.381	10138310	AA5980
MLS HEAD GASKET TH. 1,2 MM 3 HOLES	102564-5253 ^C	1120391 1250942 1349899	61-35425-20	265.391	10138320	AA5990

^A Cancels and supercedes p/n 102564-3851

^B Cancels and supercedes p/n 102564-3852

^C Cancels and supercedes p/n 102564-3853

041519-9951 FIAT PROFESSIONAL PSA GROUP

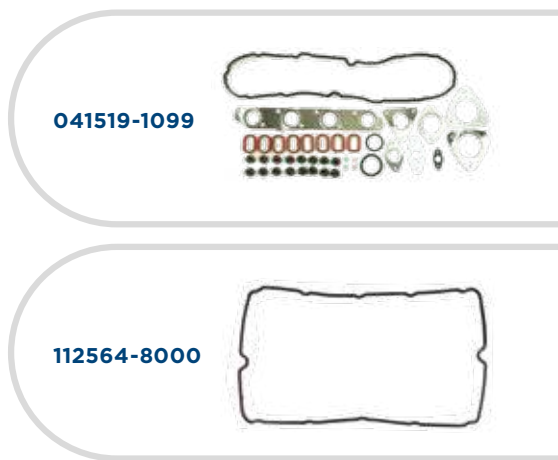

ENGINES* | MOTORI*

DISPLACEMENT
2.2 HDI 16V
2.2 MJTD 16V
—
4HU - 4HV

MODELS* | MODELLI*

CITROEN
—
JUMPER 100-120 2.2 HDI 16V

FIAT PROFESSIONAL
—
DUCATO 100 2.2 MJTD 16V

PEUGEOT
—
BOXER 100-120 2.2 HDI 16V

DESCRIPTION	P/N	CROSS REFERENCES				
		OE	RNZ	EK	AJ	PY
HEAD SET WITHOUT H.G. WITH FRONT CRANKSHAFT OIL SEAL AND VACUUM PUMP GASKET	041519-9951		02-35115-04			
HEAD SET WITHOUT H.G.	041519-1099 ^A				53028600	CH6390
CYLINDER HEAD COVER	112564-8000 ^B	1198000	71-35115-00		027.720	11088000

^A Without vacuum pump gaskets

^B Included in both kits 041519-9951 and 041519-1099

081519-1000

**FIAT PROFESSIONAL - FORD
PSA GROUP**



162564-5304



ENGINES* | MOTORI*

DISPLACEMENT

- 2.2 HDI 16V
- 2.2 MJTD 16V
- 2.0 TDDI 16V
- 2.0 TDCI 16V
- 2.2 TDCI 16V

ABFA-D3FA-D5BA-D6BA-F3FA-FIFA FMBA-HJBA-HJBB-HJBC-N7BA

- 4HU - 4HV
- P8FA-P8FB-PGFA-PGFB
- QJBA-QJBB-QJBC-QJBD
- QVFA-QWFA
- SDBA-SRFA-SRFB-SRFC-SRFD-SRFE

MODELS* | MODELLI*

CITROEN

JUMPER 100-120 2.2 HDI 16V

FIAT PROFESSIONAL

DUCATO 100 2.2 MJTD 16V

FORD

MONDEO III 2.0 TDDi 16V MANUAL & AUTOMATIC TRANSMISSION

FORD COMMERCIALI

TRANSIT BUS 2.0 TDCi 16V - TRANSIT 2.0 TDCi 16V - TRANSIT BUS 2.2 TDCi 16V
- TRANSIT 2.2 TDCi 16V - TRANSIT TOURNEO 2.2 TDCi 16V

PEUGEOT

BOXER 100-120 2.2 HDi 16V

DESCRIPTION	P/N	CROSS REFERENCES				
		OE	RNZ	EK	AJ	PY
CRANKCASE GASKET SET	081519-1000 ^A		08-35536-01	437.370 EX 903.241	54162500+ 71001800 ^B	
OIL SUMP	162564-5304 ^C	1228836	15-35536-01	027.371	59014100	HC5004

^A Cancels and supercedes p/n 082564-1000.

^B IOS oil seals not included

^C 2 piece kit - rubberized steel

101519-5251

FIAT PROFESSIONAL - FORD PSA GROUP



ENGINES* | MOTORI*

DISPLACEMENT

2.2 HDI 16V
2.2 MJTD 16V
2.0 TDDI 16V
2.0 TDCI 16V
2.2 TDCI 16V

—

P8FA-FB-PGFA-FB
QVFA-QWFA
SRFA-FB-FC-FD-FE-UHFA-B-C
4HU-4HV

MODELS* | MODELLI*

CITROEN

—
JUMPER 100-120 2.2 HDI 16V

FIAT PROFESSIONAL

—
DUCATO 100 2.2 MJTD 16V

FORD

—
TRANSIT BUS 2.2 TDCi 16V 85-110 CV - TRANSIT BUS 2.2 TDCi 16V 115-130 CV - TRANSIT BUS 2.2 TDCi 16V 140 CV - TRANSIT 2.2 TDCi 16V 85-110-115 CV - TRANSIT 2.2 TDCi 16V 130-140 CV - TRANSIT TOURNEO 2.2 TDCi 16V 110 CV - TRANSIT TOURNEO 2.2 TDCi 16V 115 CV - TRANSIT TOURNEO 2.2 TDCi 16V 130 CV - TRANSIT TOURNEO 2.2 TDCi 16V 140 CV

PEUGEOT

—
BOXER 100-120 2.2 HDi 16V

DESCRIPTION	P/N	CROSS REFERENCES				
		OE	RNZ	EK	AJ	PY
MLS HEAD GASKET TH. 1,1 MM 1 NOTCH	101519-5251	0209.EH (PSA) 9659197480 (FIAT) 1372282 (FORD)	61-37365-00	156.201	10185300	AH6390
MLS HEAD GASKET TH. 1,15 MM 2 NOTCHES	101519-5252	0209.ES (PSA) 9660534980 (FIAT) 1372297 (FORD)	61-37365-10	156.211	10185310	AH6400
MLS HEAD GASKET TH. 1,2 MM 3 NOTCHES	101519-5253	0209.ET (PSA) 9660535080 (FIAT) 1372299 (FORD)	61-37365-20	156.221	10185320	AH6410

*Find out our complete range: www.athena.eu | *Per ulteriori informazioni consultate il catalogo online nel nostro sito: www.athena.eu

041534-1099

FORD - LAND ROVER



111534-8000



ENGINES* | MOTORI*

DISPLACEMENT
2.2 TDCi 16V

—
CV24 - CVR5 - CVRA-B-C - CY24 - CYR5 - CYRA-B-C
DRR5 - DRRR-B-C - GBVAJPF - GBVAJQJ - GBVAJQW
UHR5 - USR6 - USRA-B - UYR6
DT 224 - ZSD-422

MODELS* | MODELLI*

FORD

—
RANGER (TKE) 2.2 TDCi - 2.2 TDCi 4X4 16V
TRANSIT 2.2 TDCi - 2.2 TDCi 4X4 16V

LAND ROVER

—
DEFENDER 2.2 TD4 4X4

DESCRIPTION	P/N	CROSS REFERENCES				
		OE	RNZ	EK	AJ	PY
HEAD SET WITHOUT H.G. WITH OIL SEALS	041534-1099		02-42374-02	573.370	53044400	
CYLINDER HEAD COVER	111534-8000	1760799-LR058092	71-42374-00	568.860	11131500	

*Find out our complete range: www.athena.eu | *Per ulteriori informazioni consultate il catalogo online nel nostro sito: www.athena.eu

101534-5251

FORD - LAND ROVER**ENGINES* | MOTORI*****DISPLACEMENT**
2.2 TDCi 16V

—
CV24 - CVR5 - CVRA-B-C - CY24 - CYR5 - CYRA-B-C
DRR5 - DRRRA-B-C - GBVAJPF - GBVAJQJ - GBVAJQW
UHR5 - USR6 - USRA-B - UYR6
DT 224 - ZSD-422

MODELS* | MODELLI***FORD**

—
RANGER (TKE) 2.2 TDCi - 2.2 TDCi 4x4 16V
TRANSIT 2.2 TDCi - 2.2 TDCi 4x4 16V

LAND ROVER

—
DEFENDER 2.2 Td4 4x4

DESCRIPTION	P/N	CROSS REFERENCES				
		OE	RNZ	EK	AJ	PY
MLS HEAD GASKET TH. 1,1 MM 1 HOLE	101534-5251	1776498	61-43175-00		10206800	
MLS HEAD GASKET TH. 1,15 MM 2 HOLES	101534-5252	1776501	61-43175-10		10206810	
MLS HEAD GASKET TH. 1,2 MM 3 HOLES	101534-5253	1776502	61-43175-20		10206820	

*Find out our complete range: www.athena.eu | *Per ulteriori informazioni consultate il catalogo online nel nostro sito: www.athena.eu

011520-1099

FORD - LAND ROVER

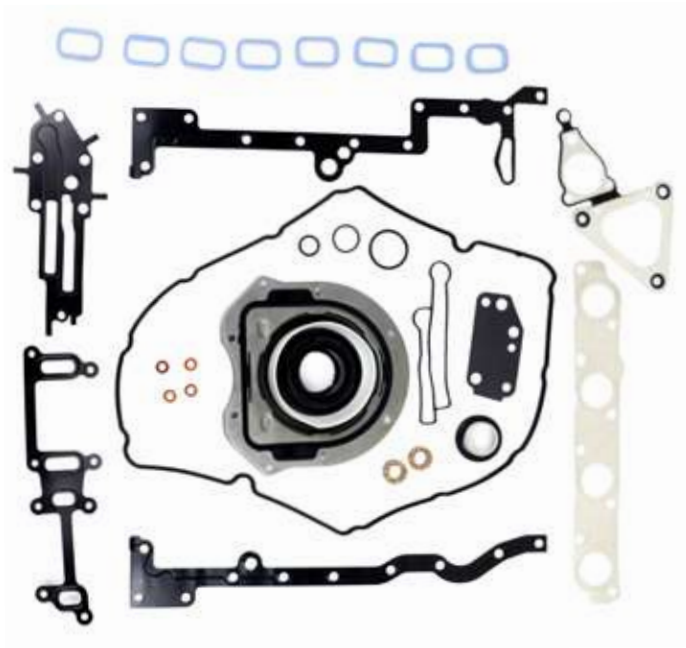

ENGINES* | MOTORI*

DISPLACEMENT
2.4 TDCI

D2FA-FB-FE - D4FA-FB-FE - D4FA - DOFA - F4FA FXFA - H9FA-FB - H9FD - JXFA - JXFC - PHFA PHFC - ZSD-424

MODELS* | MODELLI*

FORD

TRANSIT 2.4 TDCI - 2.4 TDCI 4X4

LAND ROVER

DEFENDER 2.4 TD4 4X4

DESCRIPTION	P/N	CROSS REFERENCES				
		OE	RNZ	EK	AJ	PY
FULL SET WITHOUT H.G. WITH OIL SEALS	011520-1099 ^A		01-33758-01 / 01-35115-01		51036300+ 71001800	

^A With rear integrated crankshaft oil seal p/n 997019-6900

041520-1099

FORD - LAND ROVER

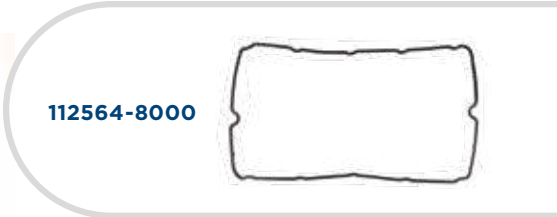
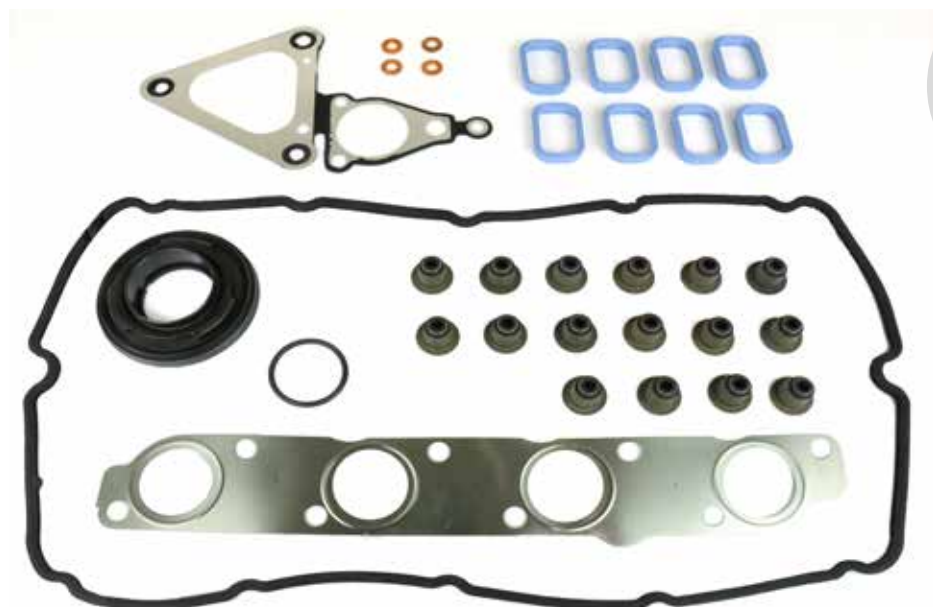

ENGINES* | MOTORI*

DISPLACEMENT
2.4 DI - TDCI - TDE - TD4 4X4 16V
 —
 D2FA-FB-FE-D4FA-DOFA
 F4FA-FXFA - H9FA-FB-FD
 JXFA - JXFC - PHFA - PHFC
 ZSD-424 (LAND ROVER)

MODELS* | MODELLI*

FORD
 —
 TRANSIT - BUS 2.4 DI 16V 75-90-120 CV
 TRANSIT - BUS 2.4 TDE 16V 115-125 CV
 TRANSIT - BUS 2.4 TDCI 16V 100-115 CV
 TRANSIT BUS 2.4 TDCI 16V 137-140 CV
 TRANSIT BUS 2.4 4X4 TDCI 16V 140 CV
 TRANSIT (RWD) 2.4 TDCI 16V 100 -115 CV
 TRANSIT (RWD) 2.4 4X4 TDCI 16V 140 CV

LAND ROVER
 —
 DEFENDER (LD) 2.4 TD4 4X4 16V

DESCRIPTION	P/N	CROSS REFERENCES				
		OE	RNZ	EK	AJ	PY
HEAD SET WITHOUT H.G. WITH OIL SEALS	041520-1099 ^A		02-35115-01 / 02-33758-05	030.652	53030500 / 53014700 / 53018800	
CYLINDER HEAD COVER	112564-8000	1198000	71-35115-00	027.720	11088000	

^A With water pump gasket

102565-5251

FORD - LAND ROVER



ENGINES* | MOTORI*

DISPLACEMENT

2.4 DI 16V

2.4 TDE 16V

2.4 TDCI 16V

2.4 TD4 4X4 16V

—
D2FA-FB-FE-D4FA-D0FA
F4FA-FXFA - H9FA-FB-FD
JXFA - JXFC - PHFA - PHFC

ZSD-424 (LAND ROVER)

MODELS* | MODELLI*

FORD

—
TRANSIT BUS 2.4 DI 16V 75-90-120 CV - TRANSIT BUS 2.4 TDE 16V 115-125 CV -
TRANSIT BUS 2.4 TDCI 16V 100-115 CV - TRANSIT BUS 2.4 TDCI 16V 137-140 CV
- TRANSIT BUS 2.4 4X4 TDCI 16V 140 CV - TRANSIT (RWD) 2.4 TDCI 16V 100 CV
- TRANSIT (RWD) 2.4 TDCI 16V 115 CV - TRANSIT (RWD) 2.4 4X4 TDCI 16V 140 CV
- TRANSIT 2.4 DI 16V 75-90-120 CV - TRANSIT 2.4 TDE 16V 115-125 CV - TRANSIT
2.4 TDCI 16V 137-140 CV

LAND ROVER

—
DEFENDER (LD) 2.4 TD4 4X4 16V

DESCRIPTION	P/N	CROSS REFERENCES				
		OE	RNZ	EK	AJ	PY
MLS HEAD GASKET TH. 1,1 MM - 1 HOLE	102565-5251^A	1349874 1096227 1256146 / LR004418	61-35420-00	265.421	10138400	AA5940
MLS HEAD GASKET TH. 1,15 MM - 2 HOLES	102565-5252^B	1349875 1096228 1256130 / LR004419	61-35420-10	265.441	10138410	AA5950
MLS HEAD GASKET TH. 1,2 MM - 3 HOLES	102565-5253^C	1349876 1096230 1256149 / LR004420	61-35420-20	265.481	10138420	AA5960

^A Cancels and supercedes p/n 102565-3851

^B Cancels and supercedes p/n 102565-3852

^C Cancels and supercedes p/n 102565-3853

052027-1000 HYUNDAI



102027-5250



ENGINES* | MOTORI*

DISPLACEMENT
1.1 12V
—
G4HD
Until/Fino al 2005

MODELS* | MODELLI*

HYUNDAI
—
ATOS 1.1 12V (MX) - ATOS PRIME 1.1 12V (MX) - GETZ 1.1 12V (TB) - SANTRO 1.1 12V (99-EUR)

DESCRIPTION	P/N	CROSS REFERENCES				
		OE	RNZ	EK	AJ	PY
HEAD SET WITH MLS H.G AND OIL SEALS	052027-1000	20920-02F00	02-53360-01	726.870	52218700	CG8060
MLS HEAD GASKET	102027-5250	22311-02800	61-53360-00	726.830	10156700	AG8060

*Find out our complete range: www.athena.eu | *Per ulteriori informazioni consultate il catalogo online nel nostro sito: www.athena.eu

032011-1000 **NEW**

FULL GASKET SET - KIT GUARNIZIONI MOTORE HYUNDAI

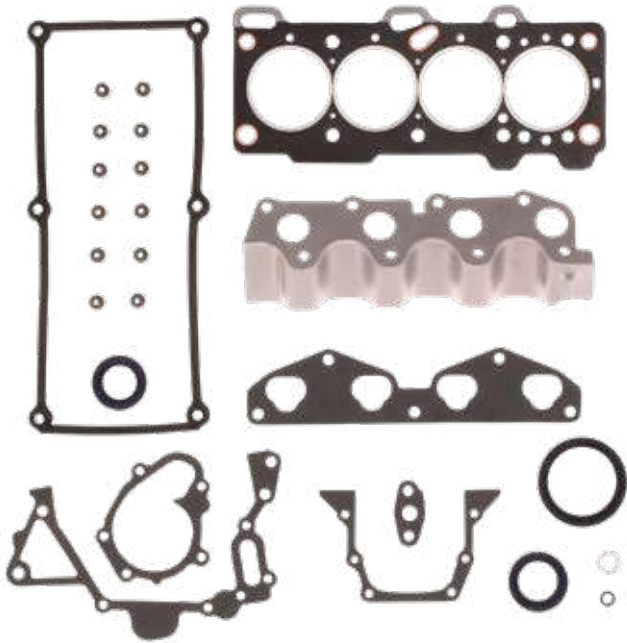

052011-1000



102011-1912



112011-8000

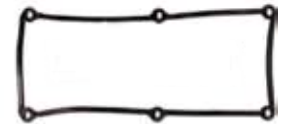

ENGINES* | MOTORI*

DISPLACEMENT | CILINDRATA

1.0 12V

CODE | CODICE

G4HC - G4HC-E

MODELS* | MODELLI*

HYUNDAI

ATOS (MX) 1.0I 12V

DESCRIPTION DESCRIZIONE	P/N		CROSS REFERENCES CORRISPONDENZE			
	GA	OE	RNZ	EK	AJ	PY
FULL GASKET SET, WITH H.G., WITH OIL SEALS KIT GUARNIZIONI MOTORE, CON T.C., CON PARAOLI	032011-1000	20910-02B00	01-53345-01	726.940 + 726.930	50173400	FG8050
CYLINDER HEAD GASKET SET, WITH H.G., WITH OIL SEALS KIT GUARNIZIONI TESTATA, CON T.C., CON PARAOLI	052011-1000	20920-02B00	02-53345-01	726.940	52160200	CG5360
CYLINDER HEAD GASKET, COMPOSITE MATERIAL 1,2 mm GUARNIZIONE TESTATA IN MATERIALE COMPOSITO	102011-1912	22311-02700	61-53345-00	527870	10119900	AG8050
CYLINDER HEAD COVER GASKET GUARNIZIONE COPRITESTATA	112011-8000		71-53419-00		11075200	JM5305

*Find out our complete range: www.athena.eu | *Per ulteriori informazioni consultate il catalogo online nel nostro sito: www.athena.eu

032027-1000

FULL GASKET SET - KIT GUARNIZIONI MOTORE HYUNDAI



052027-1000



102027-5250



112037-8000

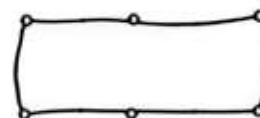

ENGINES* | MOTORI*

DISPLACEMENT | CILINDRATA

1.1 12V

CODE | CODICE

G4HD

Up to 2005 / Fino al 2005

MODELS* | MODELLI*

HYUNDAI

ATOS (MX) 1.1 12V / ATOS PRIME (MX) 1.1 12V
GETZ (TB) 1.1 12V
SANTRO (99-EUR) 1.1 12V

DESCRIPTION DESCRIZIONE	P/N		CROSS REFERENCES CORRISPONDENZE			
	GA	OE	RNZ	EK	AJ	PY
FULL GASKET SET, WITH H.G., WITH OIL SEALS KIT GUARNIZIONI MOTORE, CON T.C., CON PARAOLI	032027-1000	20910-02F00	01-53360-01		50234600	FG8060
CYLINDER HEAD GASKET SET, WITH H.G., WITH OIL SEALS KIT GUARNIZIONI TESTATA, CON T.C., CON PARAOLI	052027-1000	20920-02F00	02-53360-01	726.870	52218700	CG8060
CYLINDER HEAD GASKET, MLS GUARNIZIONE TESTATA, MLS	102027-5250	22311-02800	61-53360-00	726.830	10156700	AG8060
CYLINDER HEAD COVER GASKET GUARNIZIONE COPRITESTATA	112037-8000	22441-02400	71-53601-00	725.450	11098500	JM5306

*Find out our complete range: www.athena.eu | *Per ulteriori informazioni consultate il catalogo online nel nostro sito: www.athena.eu

052037-1000
HYUNDAI - KIA



112011-8000



112037-8000

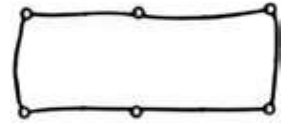

102037-5250



ENGINES* | MOTORI*

DISPLACEMENT
1.0 12V
1.1 12V
—
G4HG - SOHC

MODELS* | MODELLI*

HYUNDAI
—
ATOS PRIME 1.1 12V

KIA
—
PICANTO 1.0 12V - PICANTO 1.1 12V

DESCRIPTION	P/N	CROSS REFERENCES				
		OE	RNZ	EK	AJ	PY
HEAD SET WITH MLS H.G AND OIL SEALS	052037-1000	20920-02R00	02-53895-02	726.950	52242500	
CYLINDER HEAD COVER 9,3 mm THICK	112011-8000		71-53419-00		11075200	
CYLINDER HEAD COVER 8,2 mm THICK	112037-8000	22441-02400	71-53601-00		11098500	
MLS HEAD GASKET	102037-5250	22311-02760	61-53895-00	725.550	10168900	

*Find out our complete range: www.athena.eu | *Per ulteriori informazioni consultate il catalogo online nel nostro sito: www.athena.eu

102040-5250

HYUNDAI



ENGINES* | MOTORI*

DISPLACEMENT
1.1 12V
—
G4HG

MODELS* | MODELLI*

HYUNDAI
—
i10 1.1 12V

DESCRIPTION	P/N	CROSS REFERENCES				
		OE	RNZ	EK	AJ	PY
MLS HEAD GASKET	102040-5250	22311-02780	61-53995-10			

*Find out our complete range: www.athena.eu | *Per ulteriori informazioni consultate il catalogo online nel nostro sito: www.athena.eu

052040-1000

CYLINDER HEAD GASKET SET - KIT GUARNIZIONI TESTATA HYUNDAI

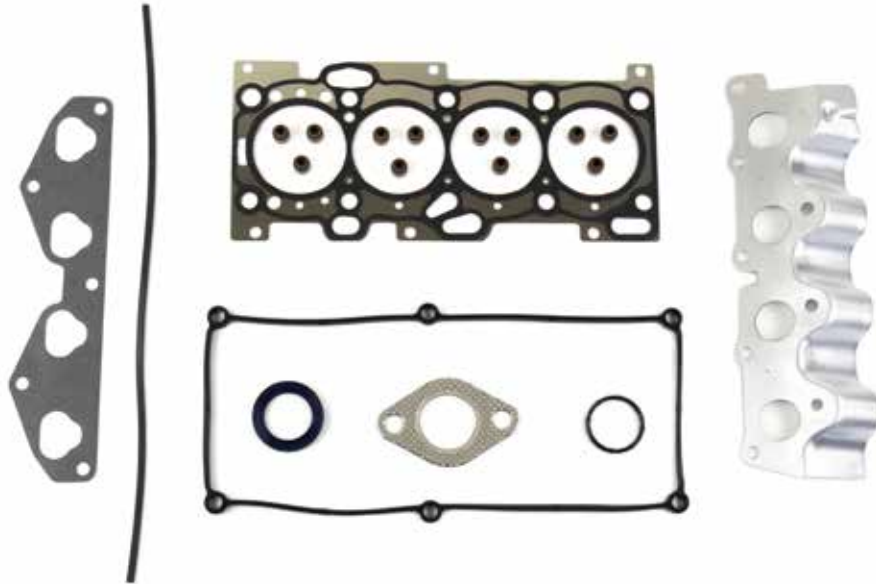

102040-5250



112037-8000

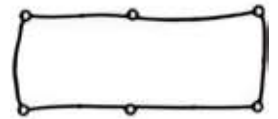

ENGINES* | MOTORI*

DISPLACEMENT | CILINDRATA

1.112V

CODE | CODICE

G4HG

MODELS* | MODELLI*

HYUNDAI

110 1.1 12V

DESCRIPTION DESCRIZIONE	P/N		CROSS REFERENCES CORRISPONDENZE			
	GA	OE	RNZ	EK	AJ	PY
CYLINDER HEAD GASKET SET, WITH H.G., WITH OIL SEALS KIT GUARNIZIONI TESTATA, CON T.C., CON PARAOLI	052040-1000	20920-02V00	02-53995-01	567.520	52343500	
CYLINDER HEAD GASKET, MLS GUARNIZIONE TESTATA, MLS	102040-5250	22311-02780	61-53995-00	483.990	10198400	
CYLINDER HEAD COVER GASKET GUARNIZIONE COPRITESTATA	112037-8000	22441-02400	71-53601-00	725.450	11098500	JM5306

*Find out our complete range: www.athena.eu | *Per ulteriori informazioni consultate il catalogo online nel nostro sito: www.athena.eu

052035-1000
HYUNDAI

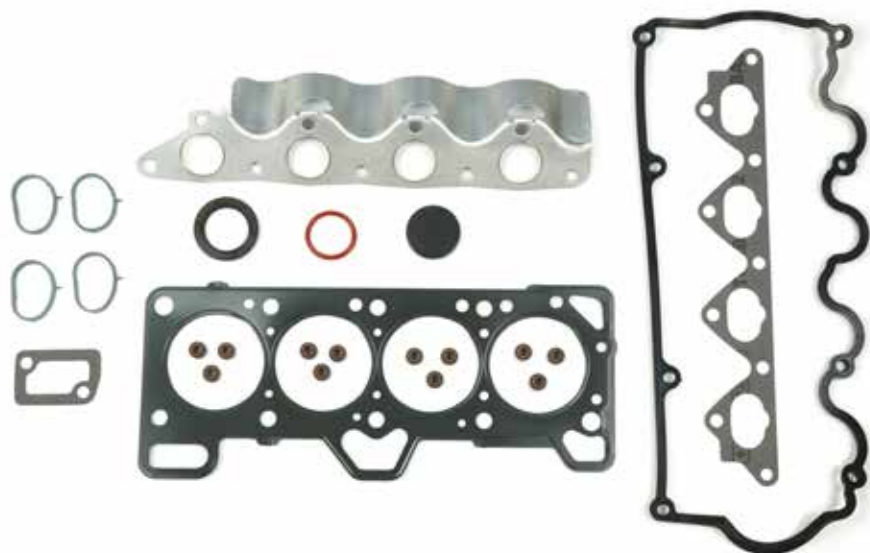

102035-5250

ENGINES* | MOTORI*

DISPLACEMENT
 1.3 12V
 —
 G4EH

MODELS* | MODELLI*

HYUNDAI
 —
 ACCENT I (X3) 1.3 - 1.3i 12V

DESCRIPTION	P/N	CROSS REFERENCES				
		OE	RNZ	EK	AJ	PY
HEAD SET WITH MLS H.G AND OIL SEALS	052035-1000	20920-22A10	02-53865-01	135.430	52231300	DY730
MLS HEAD GASKET 1 MM.	102035-5250	22311-22360	61-53865-00	135.440	10163700	AG8070

*Find out our complete range: www.athena.eu | *Per ulteriori informazioni consultate il catalogo online nel nostro sito: www.athena.eu

052038-1000
HYUNDAI - KIA



ENGINES* | MOTORI*

DISPLACEMENT
1.4 16V
 —
 G4EE

MODELS* | MODELLI*

HYUNDAI
 —
 ACCENT III 1.4 GL 16V
 GETZ 1.4i 16V

KIA
 —
 RIO II 1.4i 16V

DESCRIPTION	P/N	CROSS REFERENCES				
		OE	RNZ	EK	AJ	PY
HEAD SET WITH MLS H.G AND OIL SEALS	052038-1000	20920-26L00	02-53965-01	727.130	52265900	CH6240
MLS HEAD GASKET	102038-5250	22311-26603	61-53965-00	720.950	10183100	AH6240

*Find out our complete range: www.athena.eu | *Per ulteriori informazioni consultate il catalogo online nel nostro sito: www.athena.eu

051626-1000 HYUNDAI - KIA

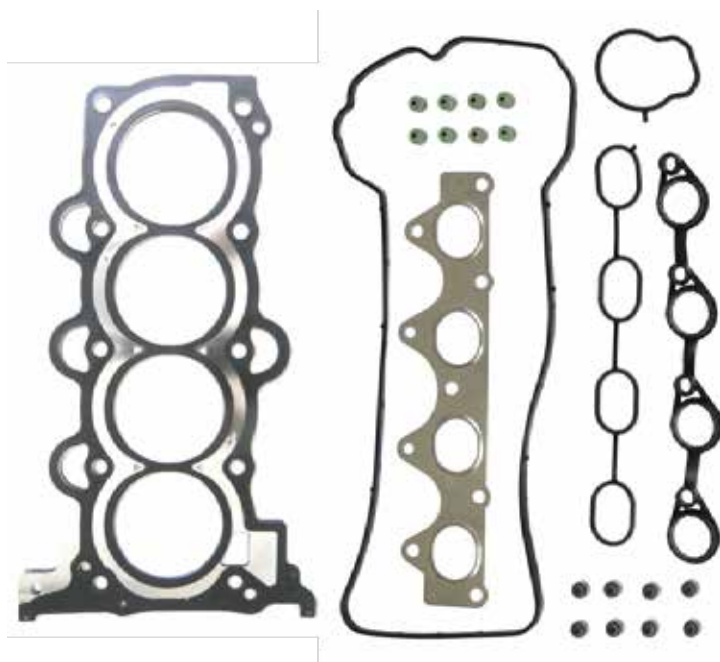

101626-5250

ENGINES* | MOTORI*

DISPLACEMENT
1.4 16V
1.6 16V
1.6 CVVT 16V
—
G4FA - G4FC

MODELS* | MODELLI*

HYUNDAI

—
I20 1.4 16V (PB-PBT / 2010-2012) -
I20 1.6 16V (PB-PBT / 2010-2012) -
I30 1.6 16V (FD / 2010-2012)

KIA

—
CARENS III 1.6 CVVT 16V (UN) - CEE'D 1.4 - 1.6 16V
(ED / 02-2009-07-2009) - CERATO 1.6 16V (LD / 02-2009-07-2009) - SOUL 1.6
CVVT 16V (AM / 02-2009-07-2011)

DESCRIPTION	P/N	CROSS REFERENCES				
		OE	RNZ	EK	AJ	PY
HEAD SET WITH MLS H.G	051626-1000	20920-2BB01	02-54020-01	344.760	52287300 52287600	
MLS HEAD GASKET	101626-5250	22311-2B003	61-54020-00	320.970	10197100	

*Find out our complete range: www.athena.eu | *Per ulteriori informazioni consultate il catalogo online nel nostro sito: www.athena.eu

102044-5251

CYLINDER HEAD GASKET - GUARNIZIONE TESTATA HYUNDAI - KIA

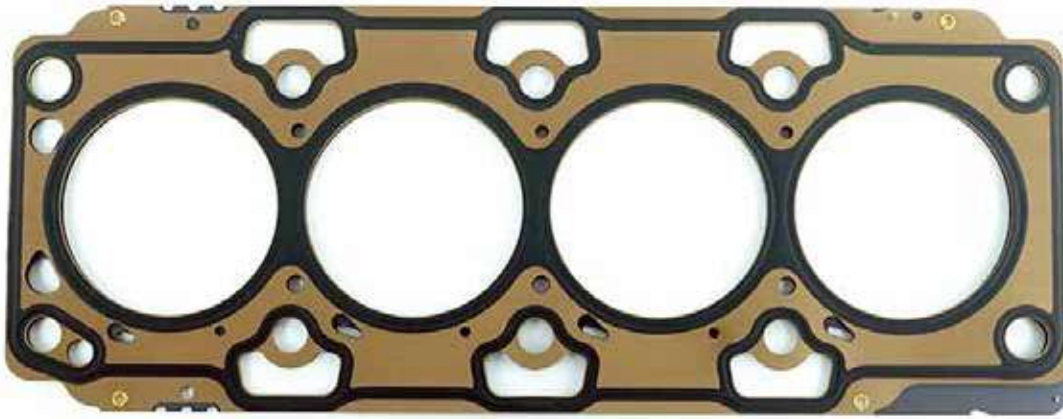

ENGINES* | MOTORI*

DISPLACEMENT | CILINDRATA

—
2.0 CRDI 16V

CODE | CODICE

—
D4EA- D4EA-F (EURO4)

MODELS* | MODELLI*

HYUNDAI

—
ELANTRA 2.0 CRDI 16V EURO4
I30 2.0 CRDI 16V - SANTA FE I 2.0 CRDI 16V EURO4
SANTA FE II - SONICA V 2.0 CRDI 16V
TRAJET - TUCSON 2.0 CRDI 16V

KIA

—
CARENS II MPV 2.0 CRDI 16V EURO4
CARENS III MPV 2.0 CRDI 115-135-140 16V - CEE'D 2.0 CRDI 140 16V
CERATO 2.0 CRDI 16V EURO4 - MAGENTIS 2.0 CRDI 16V
SPORTAGE 2.0 CRDI 16V

DESCRIPTION DESCRIZIONE	P/N		CROSS REFERENCES CORRISPONDENZE			
	GA	OE	RNZ	EK	AJ	PY
CYLINDER HEAD GASKET, MLS TH. 1,1 mm 1 NOTCH GUARNIZIONE TESTATA, MLS SP. 1,1 mm 1 TACCA	102044-5251	22311-27401	61-10010-00	442.850	10183800	
CYLINDER HEAD GASKET, MLS TH. 1,2 mm 2 NOTCHES GUARNIZIONE TESTATA, MLS SP. 1,2 mm 2 TACCHE	102044-5252	22311-27411	61-10010-10	442.880	10183810	
CYLINDER HEAD GASKET, MLS TH. 1,3 mm 3 NOTCHES GUARNIZIONE TESTATA, MLS SP. 1,3 mm 3 TACCHE	102044-5253	22311-27421	61-10010-20	442.890	10183820	

*Find out our complete range: www.athena.eu | *Per ulteriori informazioni consultate il catalogo online nel nostro sito: www.athena.eu

042039-1000
HYUNDAI

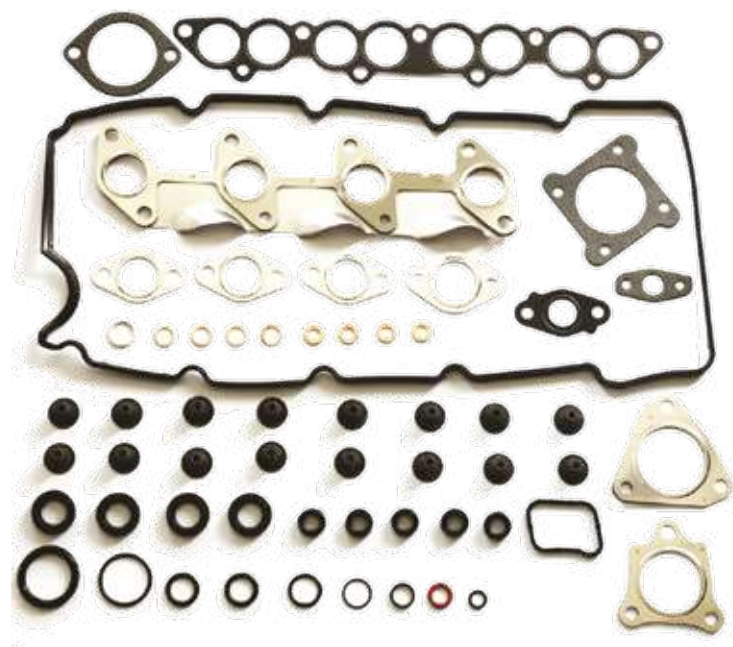

102039-5252

ENGINES* | MOTORI*

DISPLACEMENT
 1.5 CRDI
 —
 D4FA

MODELS* | MODELLI*

HYUNDAI
 —
 ACCENT III GLS 1.5 CRDI - GETZ GLS 1.5 CRDI - MATRIX VGT 1.5 CRDI

DESCRIPTION	P/N	CROSS REFERENCES				
		OE	RNZ	EK	AJ	PY
HEAD SET WITHOUT H.G.	042039-1000	20290-2BA00			53031700	
MLS HEAD GASKET 0,90 MM - 1 HOLE	102039-5252	22313-2A101	61-10024-10		10183310	

*Find out our complete range: www.athena.eu | *Per ulteriori informazioni consultate il catalogo online nel nostro sito: www.athena.eu

102042-5251
HYUNDAI - KIA



ENGINES* | MOTORI*

DISPLACEMENT
2.2 CRDI 16V
—
D4HB

MODELS* | MODELLI*

HYUNDAI
—
SANTA FE' II-III 2.2 CRDI 16V - GRAND SANTA FE' 2.2 CRDI 16V

KIA
—
CARNIVAL - GRAND CARNIVAL III - SORENTO II 2.2 CRDI 16V

DESCRIPTION	P/N	CROSS REFERENCES				
		OE	RNZ	EK	AJ	PY
MLS HEAD GASKET TH. 1,2 MM WITHOUT NOTCHES	102042-5251	22311-2F110	61-10016-00	514.291	10197300	
MLS HEAD GASKET TH. 1,3 MM 1 NOTCH	102042-5252	22311-2F100	61-10016-10	514.281	10197310	
MLS HEAD GASKET TH. 1,4 MM 2 NOTCHES	102042-5253	22311-2F120	61-10016-20	514.150	10197320	

012044-1099

FULL GASKET SET - KIT GUARNIZIONI MOTORE HYUNDAI - KIA

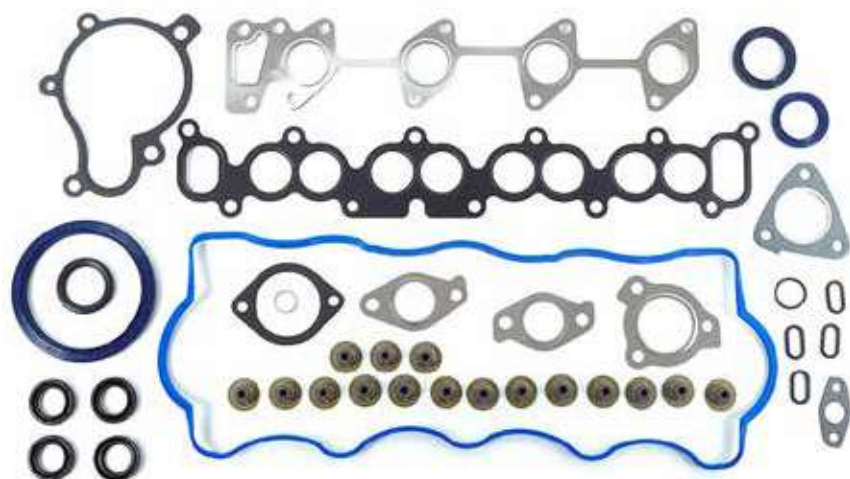

042044-1099



ENGINES* | MOTORI*

DISPLACEMENT | CILINDRATA

—
2.0 - 2.2 CRDI 16V

CODE | CODICE

—
D4EA- D4EA-F (EURO 4) - D4EB

MODELS* | MODELLI*

HYUNDAI

—
ELANTRA 2.0 CRDI 16V EURO4
I30 2.0 CRDI 16V - SANTA FE I 2.0 CRDI 16V EURO4
SANTA FE II 2.0-2.2 CRDI 16V- SONICA V 2.0 CRDI 16V
GRANDEUR 2.2 CRDI 16V
TRAJET - TUCSON 2.0 CRDI 16V

KIA

—
CARENS II MPV 2.0 CRDI 16V EURO4
CARENS III MPV 2.0 CRDI 115-135-140 16V - CEE'D 2.0 CRDI 140 16V
CERATO 2.0 CRDI 16V EURO4 - MAGENTIS 2.0 CRDI 16V
SPORTAGE 2.0 CRDI 16V

DESCRIPTION DESCRIZIONE	P/N		CROSS REFERENCES CORRISPONDENZE			
	GA	OE	RNZ	EK	AJ	PY
FULL GASKET SET, WITHOUT H.G., WITH OIL SEALS KIT GUARNIZIONI MOTORE, SENZA T.C. CON PARAOLIO	012044-1099		01-53447-03 01-10004-02		51033300 51037600	
CYLINDER HEAD GASKET SET, WITHOUT H.G., WITH OIL SEALS KIT GUARNIZIONI TESTATA, SENZA T.C., CON PARAOLIO	042044-1099		02-53447-03 02-10004-02	795.650	53032300 53027500	

*Find out our complete range: www.athena.eu | *Per ulteriori informazioni consultate il catalogo online nel nostro sito: www.athena.eu

041623-1000

KIA



ENGINES* | MOTORI*

DISPLACEMENT
2.5 CRDI 16V
 —
 D4CB (Until/Fino al 2006)

MODELS* | MODELLI*

KIA
 —
 SORENTO I (JC) 2.5 CRDI 16V

DESCRIPTION	P/N	CROSS REFERENCES				
		OE	RNZ	EK	AJ	PY
HEAD SET WITHOUT H.G. WITHOUT OIL SEALS	041623-1000		02-53496-01	240.680	53021500	CG9870

*Find out our complete range: www.athena.eu | *Per ulteriori informazioni consultate il catalogo online nel nostro sito: www.athena.eu

101623-5251

KIA**ENGINES* | MOTORI*****DISPLACEMENT**
2.5 CRDI 16V—
D4CB (Until/Fino al 2006)**MODELS* | MODELLI*****KIA**

—

SORENTO I (JC) 2.5 CRDI 16V

DESCRIPTION	P/N	CROSS REFERENCES				
		OE	RNZ	EK	AJ	PY
MLS HEAD GASKET TH. 0,78 MM - 0 NOTCHES	101623-5251	223114A010	61-53415-00	481.730	10168700	AG9870
MLS HEAD GASKET TH. 0,84 MM - 1 NOTCH	101623-5252	223114A000	61-53415-10	227.830	10168710	AG9880
MLS HEAD GASKET TH. 1 MM - 2 NOTCHES	101623-5253	223114A020	61-53415-20	481.740	10168720	AG9890

*Find out our complete range: www.athena.eu | *Per ulteriori informazioni consultate il catalogo online nel nostro sito: www.athena.eu

043826-1099

CYLINDER HEAD GASKET SET - KIT GUARNIZIONI TESTATA JAGUAR - LAND ROVER - PSA GROUP

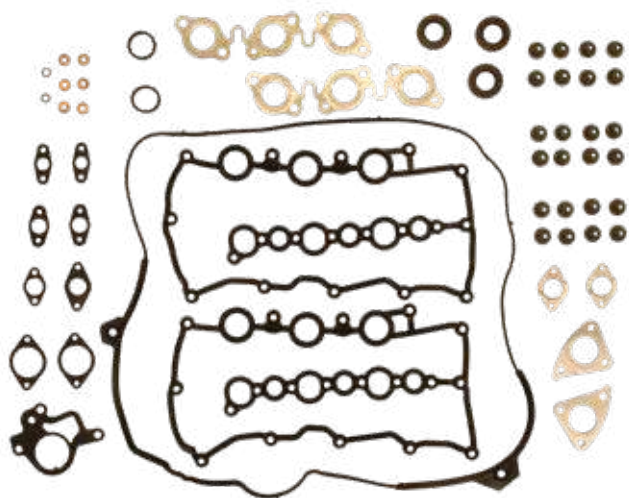

113826-8000



163826-8500



EXPERT'S NOTE - NOTA DELL'ESPERTO

Unified set for Peugeot and Land Rover 276DT / 306DT
Serie unificata per Peugeot e Land Rover 276DT / 306DT

ENGINES* | MOTORI*

DISPLACEMENT | CILINDRATA

2.7 DS 24V - 3.0 DS 24V

CODE | CODICE

276 DT
306 DT
30DDTX
UHZ (DT17BTED)
UHZ (DT17TED4)
AJD

MODELS* | MODELLI*

CITROEN

C5 III (RD) 2.7 HDI 24V / C6 (TD) 2.7 HDI 24V

JAGUAR

S-TYPE (X200) 2.7 D 24V / XF (X250) 2.7 D 24V / XJ (X350) 2.7 D 24V

LAND ROVER

DISCOVERY III (L319) 2.7 TD 4X4 24V / DISCOVERY IV(L319) 2.7 TD 4X4 - 3.0 TD 4X4 24V
DISCOVERY V (L462) 3.0 TD 4X4 24V - 3.0 TD6 4X4 24V - 3.0 SDV6 4X4 24V
RANGE ROVER IV (L405) 3.0 TDV6 4X4 24V - 3.0 SDV6 4X4 24V
RANGE ROVER SPORT (L320) 2.7 D 4X4 24V - 3.0 D 4X4 24V
RANGE ROVER SPORT (L494) 3.0 TDV6 4X4 24V - 3.0 SDV6 HYBRID 4X4 24V
RANGE ROVER VELAR (L560) 3.0 D 275-300 SDV6 4X4 24V

PEUGEOT

407 (6C-D-E) 2.7 HDI 24V / 607 (9D-U) 2.7 HDI 24V

DESCRIPTION DESCRIZIONE	P/N		CROSS REFERENCES CORRISPONDENZE			
	GA	OE	RNZ	EK	AJ	PY
CYLINDER HEAD GASKET SET, WITHOUT H.G., WITH OIL SEALS KIT GUARNIZIONI TESTATA, SENZA T.C., CON PARAOLI	043826-1099		02-38558-01 02-38558-02 02-38558-03	712.821 707.800	53020600 53040700 53047200	CH5730 CH5731
CYLINDER HEAD COVER GASKET GUARNIZIONE COPRITESTATA	113826-8000	0249.E1 1354247 1354248 JDE3880 LR029132	71-38558-00	584.890	11105300	JM7094
OIL SUMP GASKET GUARNIZIONE COPPA OLIO	163826-8500	0164.75 C2S47774 LR 005994 XR849012	71-38527-00	655.400	01112000	JH5200

032920-1000

FULL GASKET SET - KIT GUARNIZIONI MOTORE MAZDA

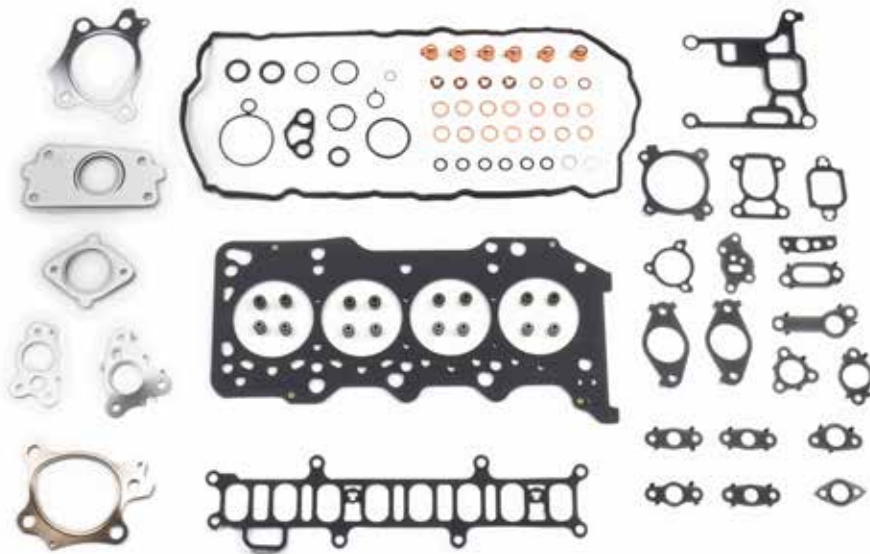

102920-5250



ENGINES* | MOTORI*

DISPLACEMENT | CILINDRATA

—
2.2 DS 16V

CODE | CODICE

—
SHY1 - SHY4

MODELS* | MODELLI*

MAZDA

—
3 (BM-BN) 2.2 D AWD 16V
6 ESTATE / SALOON (GJ-GL) 2.2 D AWD 16V
CX5 (KE-GH) 2.2 D AWD 16V

DESCRIPTION DESCRIZIONE	P/N		CROSS REFERENCES CORRISPONDENZE			
	GA	OE	RNZ	EK	AJ	PY
FULL GASKET SET, WITH H.G., WITH OIL SEALS KIT GUARNIZIONI MOTORE, CON T.C. MLS, CON PARAOLI	032920-1000	8LK1-10-271 8LGR-10-271	01-10026-01		50366400 50476700	
CYLINDER HEAD GASKET, MLS GUARNIZIONE TESTATA, MLS	102920-5250	SH01-10-271C SH01-10-271E	61-10026-00		10215300	

*Find out our complete range: www.athena.eu | *Per ulteriori informazioni consultate il catalogo online nel nostro sito: www.athena.eu

053037-1052 MERCEDES BENZ



103037-5251

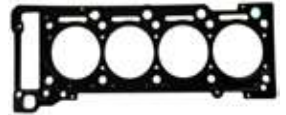

ENGINES* | MOTORI*

DISPLACEMENT
2.2 CDI 16V

OM 611.681 - OM 611.697 - OM 611.980 - OM 611A - OM 611LA

MODELS* | MODELLI*

MERCEDES BENZ

V200 CDI 2.2 16V - VITO 108-110-112 CDI 2.2 16V - SPRINTER 208-211-213-308-311-313 2.2 CDI 16V - SPRINTER 408-411-413 2.2 CDI 16V

DESCRIPTION	P/N	CROSS REFERENCES				
		OE	RNZ	EK	AJ	PY
HEAD SET WITH MLS H.G	053037-1052 ^A	611 010 4520 ^B	02-31555-02+ 15-34262-01+ 12-29491-01	131.140+ 413.470+ 133.670	52237900	CC5620
MLS HEAD GASKET THICKNESS 1,2 MM	103037-5251 ^C	646 016 0520	61-34300-00	762.811	10128100	AC5620

^A Cancels and supercedes p/n 053037-1000

^B Our composition is different from the original

^C Cancels and supercedes p/n 103037-3851

083037-1051 MERCEDES BENZ

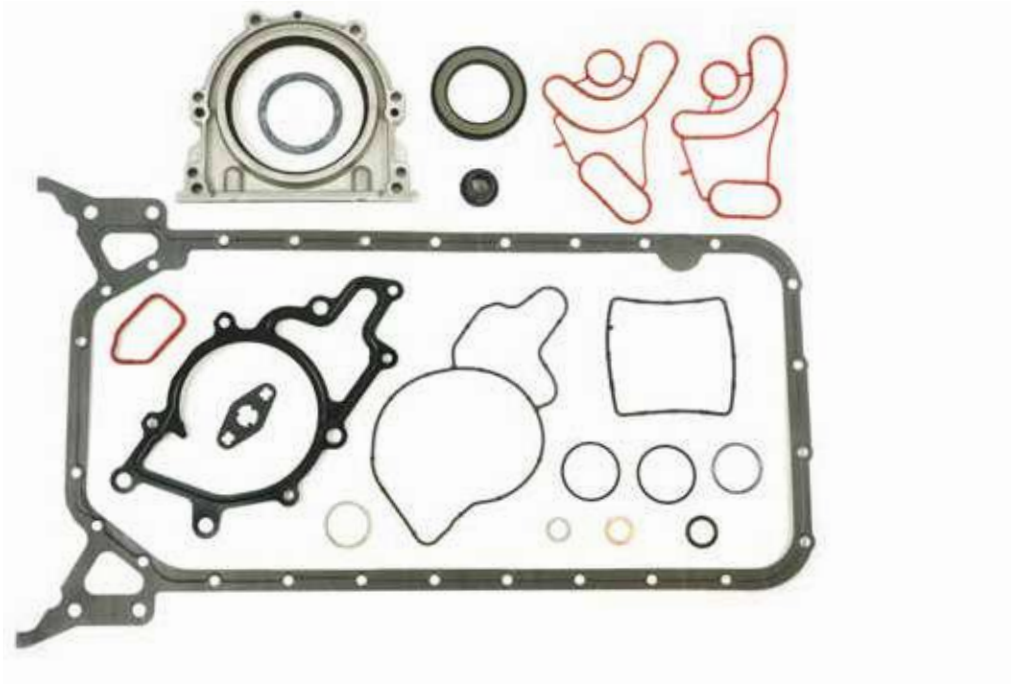

ENGINES* | MOTORI*

DISPLACEMENT
2.2 CDI 16V

—
OM 611.960-961-962 - OM 611.980-981-987 etc.

MODELS* | MODELLI*

MERCEDES BENZ

—
C200 - C220 - E200 - E220 - V200 CDI 2.2 16V
VITO 108-110-112 CDI 2.2 16V
SPRINTER 208-211-213-308-311-313-408-411-413-416 2.2 CDI 16V

DESCRIPTION	P/N	CROSS REFERENCES				
		OE	RNZ	EK	AJ	PY
CRANKCASE GASKET SET	083037-1051 ^A	611 010 0605 ^B	08-34037-02	267.000 - 294.720	54098000	EC5620

With rear integrated crankshaft oil seal p/n 997011-6900

^A Cancels and supercedes p/n 083037-1000

^B Our composition is different from the original

053071-1052

CYLINDER HEAD GASKET SET - KIT GUARNIZIONI TESTATA DODGE - JEEP - MERCEDES BENZ

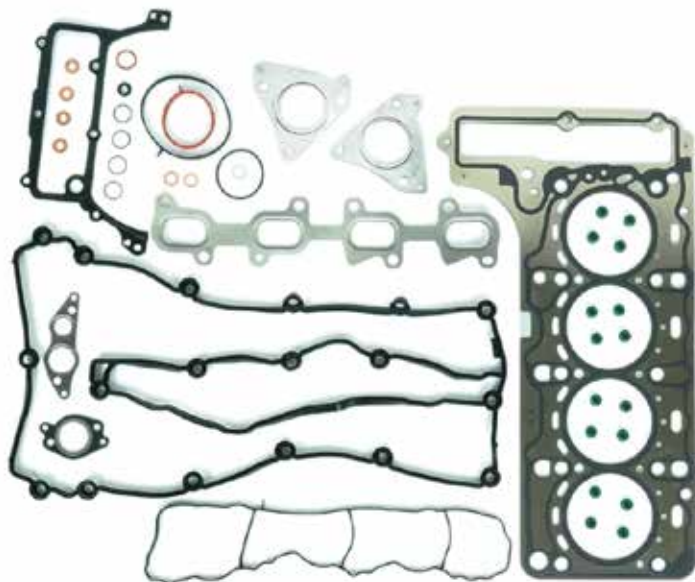

103071-5250



113071-8000

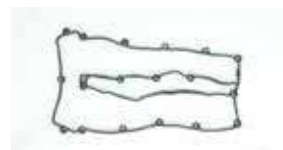

ENGINES* | MOTORI*

DISPLACEMENT | CILINDRATA

2.2 CDI - CRD 16V
Model year to / Fino a 12-2011

CODE | CODICE

OM 651.911 - OM 651.912 - OM 651.913 - OM 651.916 - OM 651.921 - OM 651.924 -
OM 651.925 - OM 651.940 - OM 651.950 - OM 651.955 - OM 651.956 - OM 651.957
- OM 651.958 - OM 651.960 - OM 651.961
Engine no. up to / Nr. motore fino a 30963977

MODELS* | MODELLI*

DODGE

CALIBER 2.2 CRD 16V

JEEP

COMPASS (MK49) 2.2 CRD
PATRIOT (MK74) 2.2 CRD

MERCEDES

CLASSE C (W204-S204) C180 - C200 - C220 - C250 2.2 CDI 16V
CLASSE E (W212-S212) E200 - E220 - E250 2.2 CDI 16V
CLASSE GLK (X204) 200 - 220 - 250 2.2 CDI 16V
SPRINTER (906) 210-213-216-310-313-316 2.2 CDI 16V
SPRINTER (906) 413-416-510-513-516 2.2 CDI 16V
VIANO (W639) 2.2 CDI 16V
VITO (W639) 110 - 113 - 116 2.2 CDI 16V
VITO (W447) 114 - 116 - 119 2.2 CDI 16V

Also available head gasket (103071-3850) with special knurl around stud bolt holes.
Head Set 053071-1000.

Disponibile anche guarnizione testata (103071-3850) con speciale zigrinatura attorno i fori passaggio prigionieri. Kit guarnizione testata 053071-1000



DESCRIPTION DESCRIZIONE	P/N		CROSS REFERENCES CORRISPONDENZE			
	GA	OE	RNZ	EK	AJ	PY
CYLINDER HEAD GASKET SET, WITH H.G. KIT GUARNIZIONI TESTATA, CON T.C.	053071-1052		02-36950-01	906.380	52382200	
CYLINDER HEAD GASKET, MLS GUARNIZIONE TESTATA, MLS	103071-5250	6510160500	61-36950-00	732.640	10211600	AH7680
CYLINDER HEAD COVER GASKET GUARNIZIONE COPRITESTATA	113071-8000	6510160021	71-40438-00	719.800	11117600	

053072-1052

CYLINDER HEAD GASKET SET - KIT GUARNIZIONI TESTATA INFINITI - MERCEDES BENZ



103071-5250



113072-8000



ENGINES* | MOTORI*

DISPLACEMENT | CILINDRATA

2.2 CDI 16V
Model year from / Anno da 12-2011

CODE | CODICE

OM 651.911 - OM 651.912 - OM 651.913 - OM 651.916 - OM 651.921 - OM 651.924 -
OM 651.925 - OM 651.940 - OM 651.950 - OM 651.955 - OM 651.956 - OM 651.957
- OM 651.958 - OM 651.960 - OM 651.961 - OM 651.980
Engine no. from / Nr. motore da: 30963978

MODELS* | MODELLI*

INFINITI

Q50 50D - Q70 (Y51) 2.2 D 16V

MERCEDES

CLASSE C (W204-S204) C180 - C200 - C220 - C250 2.2 CDI 16V
CLASSE C (W205-S205) C200D - C220D - C250D - C300 H 2.2 CDI 16V
CLASSE C (A205-C205) C220D - C250D 2.2 CDI 16V
CLASSE E (W212-S212) E200 - E220 - E250 2.2 CDI 16V
CLASSE E (A207-C207) E220 - E250 2.2 CDI 16V
CLASSE GLK (X204) 200 - 220 - 250 2.2 CDI 16V
GLC (C253-X253) 220D - 250D - CLASSE V (W447) V200-220-250 2.2 CDI 16V
SPRINTER (906) 210-213-216-310-313-316-413-416-510-513-516 2.2 CDI 16V
SPRINTER (906) 211-214-311-314-414-511-514 2.2 CDI 16V
SPRINTER (907-910) 211-214-311-314-316-411-414-416-511-514-516 2.2 CDI 16V
VIANO (W639) 2.2 CDI 16V
VITO (W639) 110 - 113 - 116 2.2 CDI 16V
VITO (W447) 114 - 116 - 119 2.2 CDI 16V

Also available head gasket (103071-3850) with special knurl around stud bolts holes. Head set 053072-1000.

Disponibile anche guarnizione testata (103071-3850) con speciale zigrinatura attorno i fori passaggio prigionieri. Kit guarnizione testata 053072-1000 .



DESCRIPTION DESCRIZIONE	P/N		CROSS REFERENCES CORRISPONDENZE			
	GA	OE	RNZ	EK	AJ	PY
CYLINDER HEAD GASKET SET, WITH H.G. KIT GUARNIZIONI TESTATA, CON T.C.	053072-1052		02-36950-02	456.210	52382300	
CYLINDER HEAD GASKET, MLS GUARNIZIONE TESTATA, MLS	103071-5250	6510160500	61-36950-00	732.640	10211600	AH7680
CYLINDER HEAD COVER GASKET GUARNIZIONE COPRITESTATA	113072-8000	6510160321	71-10774-00	429.310	11130700	

*Find out our complete range: www.athena.eu | *Per ulteriori informazioni consultate il catalogo online nel nostro sito: www.athena.eu

051911-1052

MINI



ENGINES* | MOTORI*

DISPLACEMENT
1.4 16V
1.6 16V
 —
 W10B14A
 W10B16A-W11B16A

MODELS* | MODELLI*

MINI
 —
 MINI COOPER - S 1.6 16V - MINI ONE 1.4 16V - MINI ONE 1.6 16V - MINI WORKS 1.6 16V

DESCRIPTION	P/N	CROSS REFERENCES				
		OE	RNZ	EK	AJ	PY
HEAD SET WITH MLS H.G	051911-1052 ^A	11127508545+11127508543	02-34980-01	574.310	52211000	CC5920

^A Cancels and supercedes p/n 051911-1000

053123-1000
MITSUBISHI



103123-5250



ENGINES* | **MOTORI***

DISPLACEMENT
 1.3 12V
 —
 4G13

MODELS* | **MODELLI***

mitsubishi
 —
 COLT V (CJ - CP) 1.3 12V - LANCER VI (CJ - CP) 1.3 12V

DESCRIPTION	P/N	CROSS REFERENCES				
		OE	RNZ	EK	AJ	PY
HEAD SET WITH MLS H.G AND OIL SEALS	053123-1000	MD974945		016.200	52222700	
MLS HEAD GASKET	103123-5250	MD331145		020.140	10158900	AF5470

*Find out our complete range: www.athena.eu | *Per ulteriori informazioni consultate il catalogo online nel nostro sito: www.athena.eu

033123-1000 **NEW**

FULL GASKET SET - KIT GUARNIZIONI MOTORE MITSUBISHI

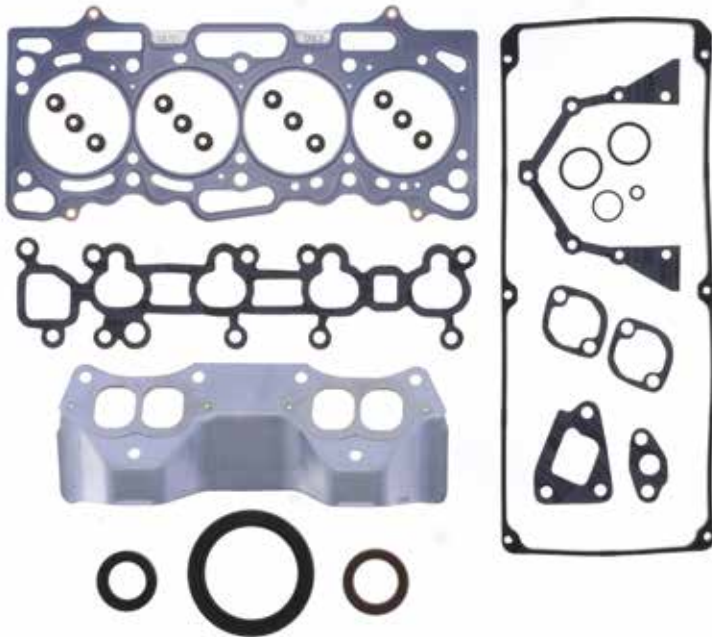

053123-1000



103123-5250



ENGINES* | MOTORI*

DISPLACEMENT | CILINDRATA

1.3L - 1.5L

CODE | CODICE

4G13 (12V) FROM 08.1995
4G15 (12V) FROM 08.1995

MODELS* | MODELLI*

MITSUBISHI

COLT V (CJ_/_CP_) 1.3 GL, GLX (CJ1A)
LANCER VI (CJ_/_CP_) 1.3 12V (CK1A)
MIRAGE V HATCHBACK (CJ_A) 1.3 (CJ1A)
MIRAGE V HATCHBACK (CJ_A) 1.5 (CJ2A)

DESCRIPTION DESCRIZIONE	P/N		CROSS REFERENCES CORRISPONDENZE			
	GA	OE	RNZ	EK	AJ	PY
FULL GASKET SET, WITH H.G., WITH OIL SEALS KIT GUARNIZIONI MOTORE, CON T.C., CON PARAOLI	033123-1000	MD974930 MD974946			50238600 50238700	FF5470
CYLINDER HEAD GASKET SET, WITH H.G. KIT GUARNIZIONI TESTATA, CON T.C.	053123-1000	MD974945		016.200	52222700	
CYLINDER HEAD GASKET, MLS, TH. 0,41MM GUARNIZIONE TESTATA, MLS SP. 0,41MM	103123-5250	MD331145	61-10709-00	020.140	10158900	AF5470

*Find out our complete range: www.athena.eu | *Per ulteriori informazioni consultate il catalogo online nel nostro sito: www.athena.eu

053113-1000
MITSUBISHI



ENGINES* | MOTORI*

DISPLACEMENT
1.6i 16V
 —
 4G18

MODELS* | MODELLI*

mitsubishi
 —
 LANCER VII (CS3A) 1.6i 16V
 SPACE STAR MPV (DG3A) 1.6i 16V

DESCRIPTION	P/N	CROSS REFERENCES				
		OE	RNZ	EK	AJ	PY
HEAD SET WITH H.G. AND OIL SEALS	053113-1000	MD978240	02-53880-01	333.450	52222800	CF5481
MLS HEAD GASKET	103113-5250	MD342397	61-53880-00	333.460	10159000	AF5480

*Find out our complete range: www.athena.eu | *Per ulteriori informazioni consultate il catalogo online nel nostro sito: www.athena.eu

013124-1099

NEW

FULL GASKET SET - KIT GUARNIZIONI MOTORE MITSUBISHI

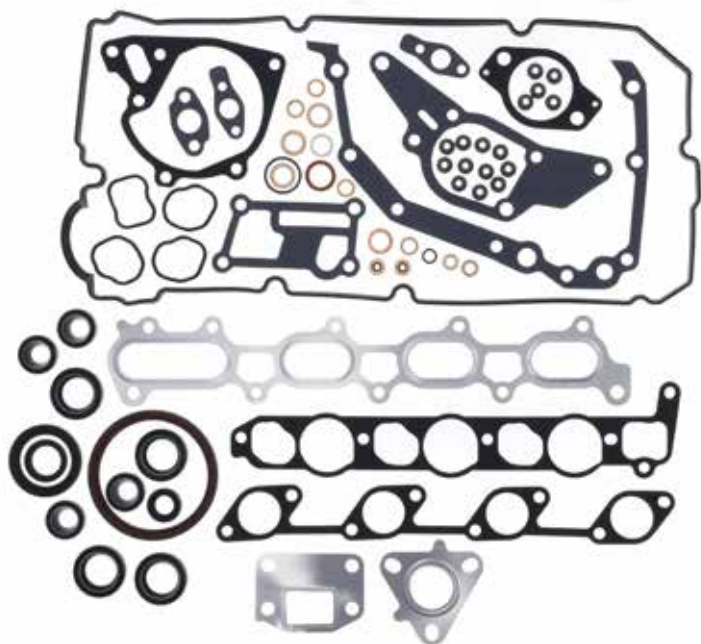

103124-5251
103124-5252
103124-5253



113124-0000

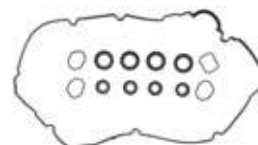

043124-1099



ENGINES* | MOTORI*

DISPLACEMENT | CILINDRATA

2.5 DS 16V

CODE | CODICE

4D56-HP

MODELS* | MODELLI*

MITSUBISHI

L200 / TRITON (KA_T - KB_T) 2.5 DI - D 16V
L200 / TRITON (KA_T - KB_T) 2.5 DI - D 4WD 16V

DESCRIPTION DESCRIZIONE	P/N		CROSS REFERENCES CORRISPONDENZE			
	GA	OE	RNZ	EK	AJ	PY
FULL GASKET SET, WITHOUT H.G., WITH OIL SEALS KIT GUARNIZIONI MOTORE, SENZA T.C. CON PARAOLI	013124-1099		01-16987-01	835.870	51075300	
CYLINDER HEAD GASKET SET, WITHOUT H.G., WITH OIL SEALS KIT GUARNIZIONI TESTATA, SENZA T.C. CON PARAOLI	043124-1099		02-16987-01	835.880	53070300	
CYLINDER HEAD GASKET, MLS - TH. 0,95 MM GUARNIZIONE TESTATA, MLS - SP. 0,95 MM	103124-5251 *	1005A205 *	61-10645-00 **		10193700 *	
CYLINDER HEAD GASKET, MLS - TH. 1,00 MM GUARNIZIONE TESTATA, MLS - SP. 1,00 MM	103124-5252 *	1005A206 *	61-10645-10 **		10193710 *	
CYLINDER HEAD GASKET, MLS - TH. 1,05 MM GUARNIZIONE TESTATA, MLS - SP. 1,05 MM	103124-5253 *	1005A207 *	61-10645-20 **		10193720 *	
CYLINDER HEAD COVER GASKET SET KIT GUARNIZIONI COPRITESTATA	113124-0000		15-16987-01		56065400	

* Except EURO 5 - Tranne EURO 5

** Only EURO 5 - Solo EURO 5

013114-1000

HYUNDAI - KIA - MITSUBISHI



043114-1000



113101-0000



ENGINES* | MOTORI*

DISPLACEMENT
2.5

4D56T - 4D56TD - H.G.I - II H.G.I
D4BA - D4BB - D4BF - D4BH

MODELS* | MODELLI*

HYUNDAI

GALLOPER II 2.5 TD - TDI (JK-01) 8V - H1 - STAREX 2.5 D - TD - 4WD - H.G.I 8V -
PORTER 2.5 TD - TERRACAN 2.5 TD (HP) 8V

KIA

PREGIO 2.5 D - H.G.I 8V

MITSUBISHI

MONTERO 2.5 TD (K90) 8V - PAJERO III 2.5 TDI - PAJERO CLASSIC 2.5 TD 8V -
PAJERO SPORT 2.5 TD (K94W) 8V - L200 (K74T) - L300 (P25W-V) 2.5 TD 4WD
8V - L400 - SPACE GEAR 2.5 TD (PD5W-V) 8V

DESCRIPTION	P/N	CROSS REFERENCES				
		OE	RNZ	EK	AJ	PY
FULL SET WITHOUT H.G. WITH OIL SEALS	013114-1000		01-52244-01		51023600	
HEAD SET WITHOUT H.G. WITH OIL SEALS	043114-1000		02-52244-01	354.120 ^A	53019000	
CYLINDER HEAD COVER SET	113101-0000	MD050312	15-52244-01	822.050		JN403

^A With cylinder head gasket - thickness 1,5mm

103114-5251

HYUNDAI - KIA - MITSUBISHI



ENGINES* | MOTORI*

**DISPLACEMENT
2.5 TD - TDI**

—
4D56T - 4D56TD
D4BA - D4BB - D4BF
D4BH (4D56H.G.1 - 4D56 IL H.G.1)

MODELS* | MODELLI*

HYUNDAI

—
GALLOPER II 2.5 TD - TDI (JK-01) - H1 - STAREX 2.5 D - TD - 4WD - H.G.1 -
PORTER 2.5 TD - TERRACAN 2.5 TD (HP)

KIA

—
PREGIO 2.5 D - H.G.1

MITSUBISHI

—
MONTERO 2.5 TD (K90) - PAJERO III 2.5 TDI - PAJERO CLASSIC 2.5 TD -
PAJERO SPORT 2.5 TD (K94W) - L200 2.5 TD 4WD (K74T) - L300 2.5 TD 4WD
(P25W-V) - L400 - SPACE GEAR 2.5 TD (PD5W-V)

DESCRIPTION	P/N	CROSS REFERENCES				
		OE	RNZ	EK	AJ	PY
MLS HEAD GASKET TH. 1,45 MM. 3+0 HOLES	103114-5251	MD 377774	61-53700-00	263.410	10159300	AH6480
MLS HEAD GASKET TH. 1,50 MM. 3+1 HOLE	103114-5252	MD 377775	61-53700-10	431.070	10159310	AH6490
MLS HEAD GASKET TH. 1,55 MM. 3+2 HOLES	103114-5253	MD 377776	61-53700-20	431.080	10159320	AH6500

052450-1000
NISSAN



102450-5250

ENGINES* | MOTORI*

DISPLACEMENT
1.4l 16V
 —
 CR14DE

MODELS* | MODELLI*

NISSAN
 —
 MICRA III - C+C III - NOTE 1.4 16V

DESCRIPTION	P/N	CROSS REFERENCES				
		OE	RNZ	EK	AJ	PY
HEAD SET WITH MLS H.G	052450-1000	11042-AX03J	02-34185-02	382.500	52352100	CH6300
MLS H.G. 0.6 MM	102450-5250	11044-BX005	61-34185-00	306.340	10180600	AH6300

*Find out our complete range: www.athena.eu | *Per ulteriori informazioni consultate il catalogo online nel nostro sito: www.athena.eu

052455-1000

NISSAN

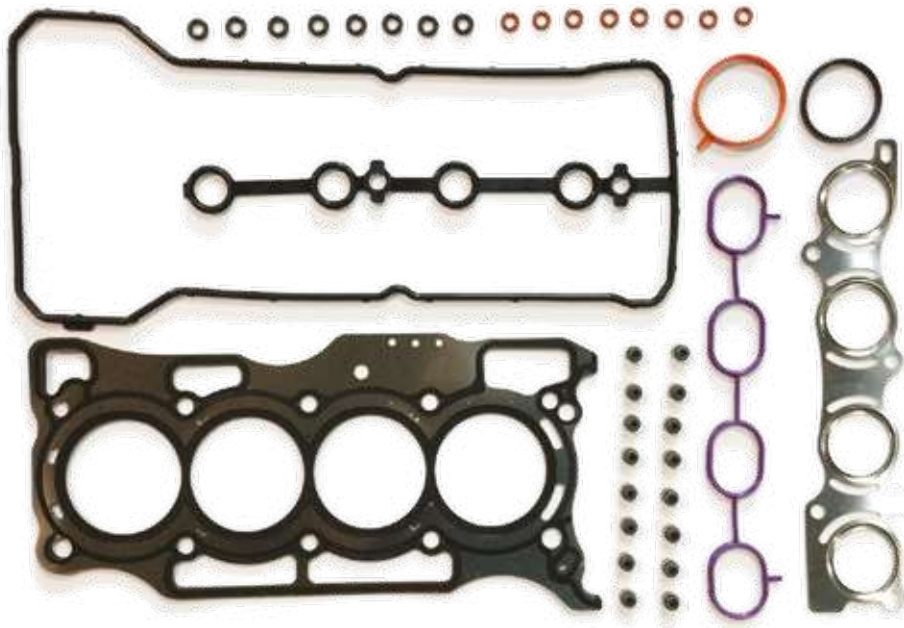

102455-5250



ENGINES* | MOTORI*

DISPLACEMENT
1.6 16V
—
HR16DE
From/Dal 2010

MODELS* | MODELLI*

NISSAN
—
QASHQAI 1.6 16V (J10E) - QASHQAI +2 1.6 16V (JJ10E) - JUKE 1.6 16V (UK MAKE)

Model	Body	Transmission	From Date	To Date
QASHQAI	5H/B	F5	2010-01	-
QASHQAI	5H/B	MCVT	2011-11	-
QASHQAI+2	3ROW	F5	2010-01	-
JUKE UK MAKE	5HB	F5-CVT	2010-07	2014-05
JUKE UK MAKE	5HB	F5	2011-08	2014-05
JUKE UK MAKE	5HB	CVT	2012-09	2014-05
JUKE UK MAKE	5HB	F5-CVT	2013-02	2014-05
JUKE UK MAKE	5HB	F5-CVT	2014-05	-
JUKE UK MAKE	5HB	CVT	2014-06	-

DESCRIPTION	P/N	CROSS REFERENCES				
		OE	RNZ	EK	AJ	PY
HEAD SET WITH MLS H.G	052455-1000	11042-1KTOA / A1MDB-1KTOA	02-10229-01	476.380		
MLS H.G.	102455-5250	11044-1KTOA / 110449922R	61-10229-00	774.940	10214300	

*Find out our complete range: www.athena.eu | *Per ulteriori informazioni consultate il catalogo online nel nostro sito: www.athena.eu

052451-1000

NISSAN

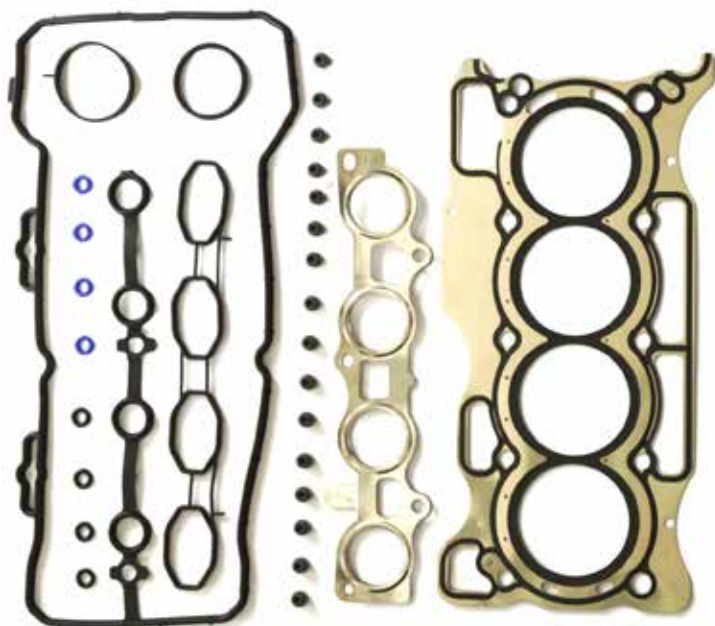

102451-5250

ENGINES* | MOTORI*

DISPLACEMENT
1.6 16V
—
HR16DE

MODELS* | MODELLI*

NISSAN
—
LIVINA 1.6 16V - MICRA C+C 160 SR 1.6 16V - MICRA III 160 SR 1.6 16V - NOTE 1.6 16V - QASHQAI + 2 1.6 16V - QASHQAI 2 1.6 16V - TIIDA 1.6 16V

DESCRIPTION	P/N	CROSS REFERENCES				
		OE	RNZ	EK	AJ	PY
HEAD SET WITH MLS H.G	052451-1000	11042-EE027	02-37855-01	794.650	52267700	
MLS HEAD GASKET	102451-5250	11044-BC20B	61-37855-00	302.850	10183500	

*Find out our complete range: www.athena.eu | *Per ulteriori informazioni consultate il catalogo online nel nostro sito: www.athena.eu

042454-1000

NISSAN



ENGINES* | MOTORI*

DISPLACEMENT
2.5 dCi 16V

—
YD25DDTI
From/Dal 2006 (CABSTAR)
From/Dal 2006 -2010 (NAVARA-PATHFINDER)

MODELS* | MODELLI*

NISSAN

—
CABSTAR 2.5 dCi 16V (F24M) - NAVARA 4WD 2.5 dCi 16V (D40M) - PATHFINDER
4WD 2.5 dCi 16V (R51M)

DESCRIPTION	P/N	CROSS REFERENCES				
		OE	RNZ	EK	AJ	PY
HEAD SET WITHOUT H.G.	042454-1000	11042-BN027	02-53694-01		53026300	

102454-5253

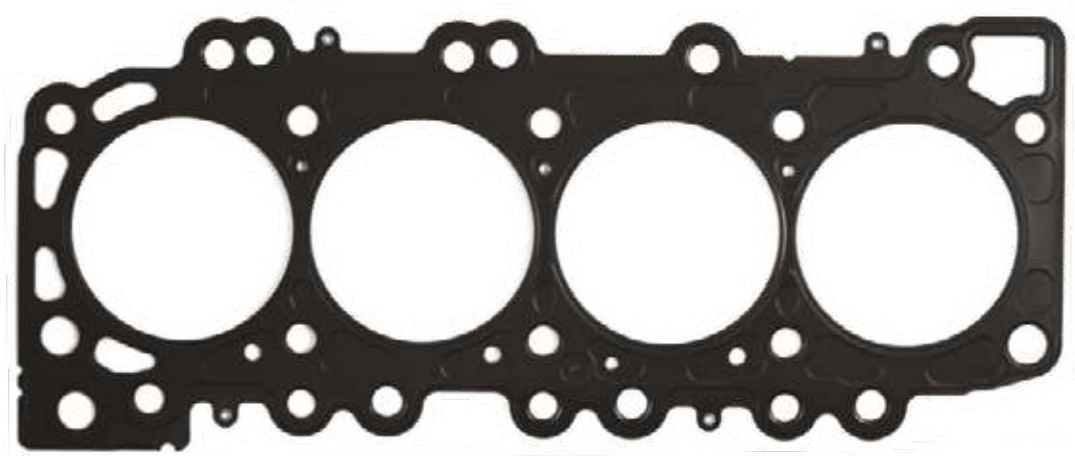
NISSAN**ENGINES* | MOTORI*****DISPLACEMENT**
2.5 dCi 16V

—

YD25DDTI

From/Dal 2006 (CABSTAR)

From/Dal 2006 -2010 (NAVARA-PATHFINDER)

MODELS* | MODELLI***NISSAN**

—

CABSTAR 2.5 dCi 16V (F24M) - NAVARA 4WD 2.5 dCi 16V (D40M) - PATHFINDER
4WD 2.5 dCi 16V (R51M)

DESCRIPTION	P/N	CROSS REFERENCES				
		OE	RNZ	EK	AJ	PY
MLS HEAD GASKET 0,95 MM 2+1 NOTCHES	102454-5253	11044-VK502	61-53635-20	715.210	10160220	
MLS HEAD GASKET 0,975 MM 3+1 NOTCHES	102454-5254	11044-VK503	61-53635-30	715.170	10160230	
MLS HEAD GASKET 1,025 MM 3+3 NOTCHES	102454-5256	11044-VK505	61-53635-50	715.100	10160250	AH5360

*Find out our complete range: www.athena.eu | *Per ulteriori informazioni consultate il catalogo online nel nostro sito: www.athena.eu

042456-1000

NISSAN

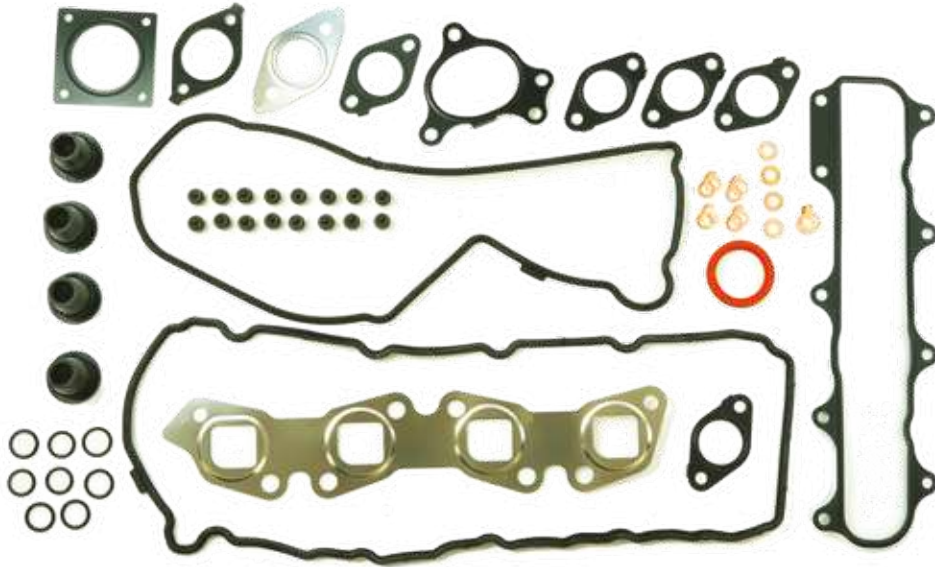

ENGINES* | MOTORI*

DISPLACEMENT
2.5 dCi - dCi 16V
—
YD25DDTi

MODELS* | MODELLI*

NISSAN
—
NAVARA 4WD (D40) - PATHFINDER III 4WD (R51M) 2.5 dCi 16V (FROM 2010)
CABSTAR (F24M) 28-33-34-35.12 - 35-45.14 2.5 dCi 16V
(FROM 2011)

DESCRIPTION	P/N	CROSS REFERENCES				
		OE	RNZ	EK	AJ	PY
HEAD SET WITHOUT H.G.	042456-1000	A10425X00A	02-12587-01		53050900	

102456-5251

NISSAN**ENGINES* | MOTORI***

DISPLACEMENT
2.5 dCi - dCi 16V
—
YD25DDTi

MODELS* | MODELLI*

NISSAN
—
NAVARA 4WD (D40) - PATHFINDER III 4WD (R51) 2.5 dCi 16V (FROM 2010)
CABSTAR (F24M) 28-33-34-35.12 - 35-45.14 2.5 dCi 16V
(FROM 2011)

DESCRIPTION	P/N	CROSS REFERENCES				
		OE	RNZ	EK	AJ	PY
MLS HEAD GASKET TH. 0,9 MM 0 NOTCHES	102456-5251	110445X00A	61-10230-00	549.240	10214200	
MLS HEAD GASKET TH. 0,925 MM 1 NOTCH	102456-5252	110445X01A	61-10230-10	549.250	10214210	
MLS HEAD GASKET TH. 0,95 MM 2 NOTCHES	102456-5253	110445X02A	61-10230-20	549.260	10214220	
MLS HEAD GASKET TH. 0,975 MM 3 NOTCHES	102456-5254	110445X03A	61-10230-30	549.270	10214230	
MLS HEAD GASKET TH. 1 MM 4 NOTCHES	102456-5255	110445X04A	61-10230-40	549.280	10214240	
MLS HEAD GASKET TH. 1,025 MM 5 NOTCHES	102456-5256	110445X05A	61-10230-50	549.290	10214250	

*Find out our complete range: www.athena.eu | *Per ulteriori informazioni consultate il catalogo online nel nostro sito: www.athena.eu

042453-1000
NISSAN



ENGINES* | MOTORI*

DISPLACEMENT
3.0 DTI 16V
3.0 DI 4WD 16V
 —
 ZD30
 2002 - 2004 (TERRANO)
 ZD30 DDTI
 2000-2006 (PATROL)

MODELS* | MODELLI*

NISSAN
 —
 PATROL GR II 3.0 DTI 16V (Y61) - TERRANO II 3.0 DI 4WD 16V (R20)

DESCRIPTION	P/N	CROSS REFERENCES				
		OE	RNZ	EK	AJ	PY
HEAD SET WITHOUT H.G.	042453-1000	11042-VC125- 11042-VC126	02-53583-01	372.610	53016000	CF5740

102453-5251

NISSAN - OPEL - RENAULT**ENGINES* | MOTORI*****DISPLACEMENT****3.0 DTI 16V****3.0 DI 4WD 16V****3.0 dCi 16V**

—

ZD30 2002-2004 (TERRANO II)

ZD30 DDTI 2000-2006 (PATROL)

ZD3 200 1999-2006 (OPEL-RENAULT)

ZD3 202 1999-2006 (OPEL-RENAULT)

MODELS* | MODELLI***NISSAN**

—

PATROL GR II 3.0 DTI 16V (Y61) - TERRANO II 3.0 DI 4WD 16V (R20)

OPEL

—

MOVANO A 3.0 DTI 16V (F9-Y9)

RENAULT

—

MASTER II 3.0 dCi 16V (L1H1)

DESCRIPTION	P/N	CROSS REFERENCES				
		OE	RNZ	EK	AJ	PY
MLS HEAD GASKET TH. 0,65 MM 1 NOTCH	102453-5251	11044-VC100	61-53530-00	272.620	10150310	AF5740
MLS HEAD GASKET TH. 0,70 MM 2 NOTCHES	102453-5252	11044-VC101	61-53530-10	323.510	10150300	AF5750

*Find out our complete range: www.athena.eu | *Per ulteriori informazioni consultate il catalogo online nel nostro sito: www.athena.eu

042457-1099

CYLINDER HEAD GASKET SET - KIT GUARNIZIONI TESTATA NISSAN - RENAULT TRUCKS



ENGINES* | MOTORI*

DISPLACEMENT | CILINDRATA

3.0 DCI - DTI - DXI 16V

CODE | CODICE

Z30DDTI (Up to / Fino al 2011) - DXI3 - ZD3A604

MODELS* | MODELLI*

NISSAN

ATLEON 35.15 - 56.15 3,0 DTI 16V
CABSTAR 35.14 (F24M-W) 3,0 DCI 16V
CABSTAR 35.15 - 45.15 (F24M-W) 3,0 DCI 16V
PATROL GR V WAGON (Y61) 3,0 DTI 16V

RENAULT TRUCKS

MASCOTT 120.35-55-65 - 160.35-55-65 3,0 DXI 16V
MAXITY 150.35-45 3,0 DXI 16V

DESCRIPTION DESCRIZIONE	P/N		CROSS REFERENCES CORRISPONDENZE			
	GA	OE	RNZ	EK	AJ	PY
CYLINDER HEAD GASKET SET, WITHOUT H.G., WITH OIL SEALS KIT GUARNIZIONI TESTATA, SENZA T.C., CON PARAOLIO	042457-1099	A1M42MA70A A1042MA70A		757.520	53026600	

102457-5251

CYLINDER HEAD GASKET - GUARNIZIONE TESTATA NISSAN - RENAULT TRUCKS



ENGINES* | MOTORI*

DISPLACEMENT | CILINDRATA

—
3,0 DCI - DTI - DXI 16V

CODE | CODICE

—
Z30DDTI - DXI3

MODELS* | MODELLI*

NISSAN

—
ATLEON 35.15 - 56.15 3,0 DTI 16V
CABSTAR 35.14 (F24M-W) 3,0 DCI 16V
CABSTAR 35.15 - 45.15 (F24M-W) 3,0 DCI 16V
NT 400 CABSTAR 35.13-15-45.15 (F24F) 3,0 DI 16V
NT 500 35.15-HD - 56.15 - 65.15 3,0 DI 16V
PATROL GR V WAGON (Y61) 3,0 DTI 16V
TERRANO II (R20) 3,0 4WD DI 16V

RENAULT TRUCKS

—
MAXITY 150.35-45 3,0 DXI 16V

DESCRIPTION DESCRIZIONE	P/N		CROSS REFERENCES CORRISPONDENZE			
	GA	OE	RNZ	EK	AJ	PY
CYLINDER HEAD GASKET, MLS TH. 0,55 mm 1 NOTCH GUARNIZIONE TESTATA, MLS SP. 0,55 mm 1 TACCA	102457-5251	11044-MA70A		330.750	10181100	
CYLINDER HEAD GASKET, MLS TH. 0,60 mm 2 NOTCHES GUARNIZIONE TESTATA, MLS SP. 0,60 mm 2 TACCHE	102457-5252	11044-MA70B		330.760	10181110	
CYLINDER HEAD GASKET, MLS TH. 0,65 mm 3 NOTCHES GUARNIZIONE TESTATA, MLS SP. 0,65 mm 3 TACCHE	102457-5253	11044-MA70C		330.770	10181120	

*Find out our complete range: www.athena.eu | *Per ulteriori informazioni consultate il catalogo online nel nostro sito: www.athena.eu

053590-1000
OPEL - SUZUKI

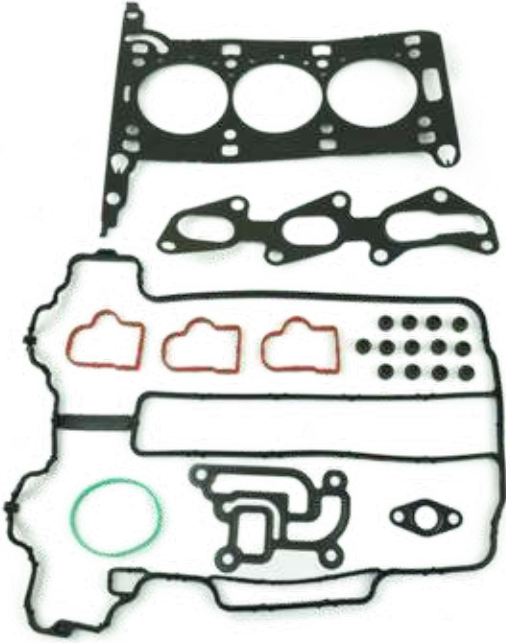

103590-3850



113574-8000

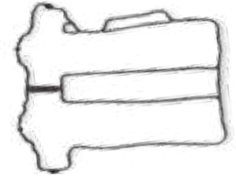

ENGINES* | MOTORI*

DISPLACEMENT
1.0 12V
—
Z10XEP

MODELS* | MODELLI*

OPEL
—
AGILA A 1.0 12V - CORSA C - D 1.0 12V - CORSA D VAN 1.0 12V

SUZUKI
—
WAGON R+ 1.0 12V

DESCRIPTION	P/N	CROSS REFERENCES				
		OE	RNZ	EK	AJ	PY
HEAD SET WITH MLS H.G (ORIGINAL PROD.)	053590-1000	1606246	02-37250-01	434.340	52261800	CE5950
MLS H.G (ORIGINAL PROD.)	103590-3850	5607838	61-37250-00	050.930	10179000	AE5950
CYLINDER HEAD COVER	113574-8000	607499	71-34818-00	111.470	11112500	JM5121

*Find out our complete range: www.athena.eu | *Per ulteriori informazioni consultate il catalogo online nel nostro sito: www.athena.eu

053590-1052 OPEL - SUZUKI

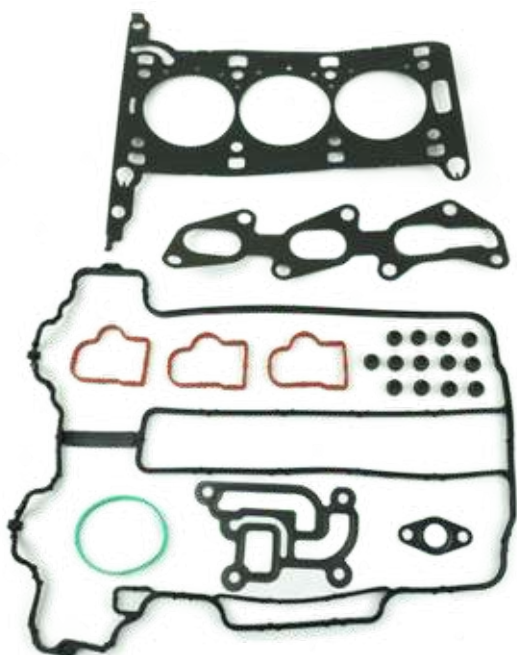

ENGINES* | MOTORI*

DISPLACEMENT
1.0 12V
—
Z10XEP

MODELS* | MODELLI*

OPEL
—
AGILA A 1.0 12V - CORSA C - D 1.0 12V - CORSA D VAN 1.0 12V

SUZUKI
—
WAGON R+ 1.0 12V

DESCRIPTION	P/N	CROSS REFERENCES				
		OE	RNZ	EK	AJ	PY
HEAD SET WITH MLS H.G. (OUR PRODUCTION)	053590-1052 ^A	1606246	02-37250-01	434.340	52261800	CE5950
MLS H.G. (OUR PRODUCTION)	103590-5250	5607838	61-37250-00	050.930	10179000	AE5950
CYLINDER HEAD COVER	113574-8000	607499	71-34818-00	111.470	11112500	JM5121

^A Interchangeable with p/n 053590-1000.

*Find out our complete range: www.athena.eu | *Per ulteriori informazioni consultate il catalogo online nel nostro sito: www.athena.eu

053597-1052

OPEL

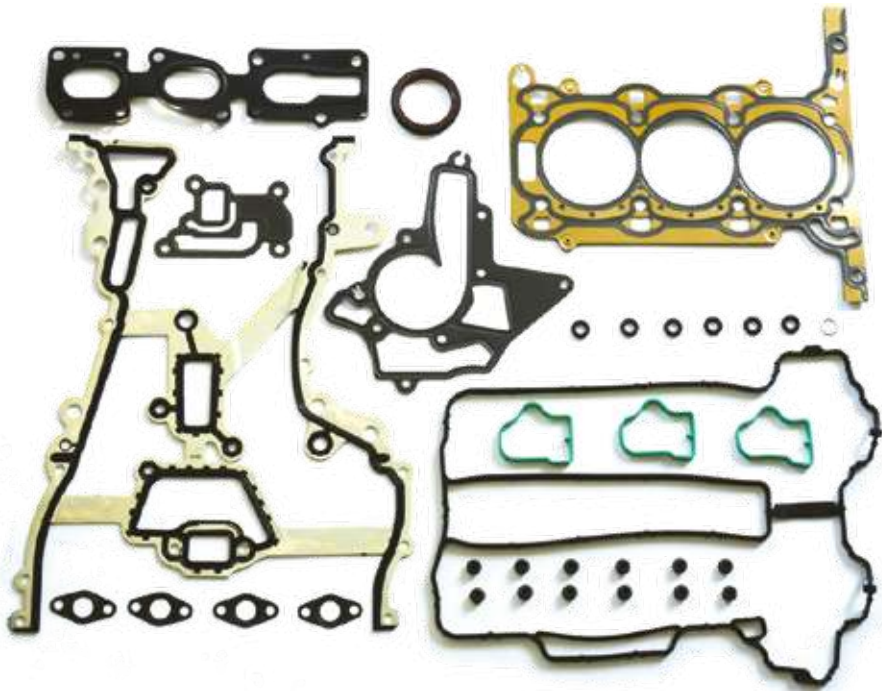

ENGINES* | MOTORI*

DISPLACEMENT
1.0 12V
—
A10XEP

MODELS* | MODELLI*

OPEL
—
CORSA D 1.0 12V - CORSA D VAN 1.0 12V

DESCRIPTION	P/N	CROSS REFERENCES				
		OE	RNZ	EK	AJ	PY
HEAD SET WITH MLS H.G. AND OIL SEALS	053597-1052	1606423	02-37890-01	427.280	52364300	
MLS HEAD GASKET	103597-5250	607163	61-37890-00	493.151	10205800	

*Find out our complete range: www.athena.eu | *Per ulteriori informazioni consultate il catalogo online nel nostro sito: www.athena.eu

058411-1000

NISSAN - OPEL - SUZUKI



ENGINES* | MOTORI*

DISPLACEMENT
 1.0 12V
 1.0 LPG 16V
 1.0 16V
 —
 K10B

MODELS* | MODELLI*

NISSAN
 —
 PIXO 1.0 12V (UAO)

OPEL
 —
 AGILA B 1.0 - 1.0 LPG 16V (H08)

SUZUKI
 —
 ALTO V 1.0 12V - SPLASH 1.0 16V (A5B310)

DESCRIPTION	P/N	CROSS REFERENCES				
		OE	RNZ	EK	AJ	PY
HEAD SET WITH MLS H.G	058411-1000	4709983 - 93194605	02-37655-01	789.670	52278100	
MLS H.G.	108411-5250	4708883 11044-4A00A	61-37655-00	112.120		AH6620

*Find out our complete range: www.athena.eu | *Per ulteriori informazioni consultate il catalogo online nel nostro sito: www.athena.eu

053596-1000
OPEL - SUZUKI



103596-5250



ENGINES* | MOTORI*

DISPLACEMENT
1.2 - 1.2 LPG 16V
1.2 - 1.2 VVT 16V
—
K12B

MODELS* | MODELLI*

OPEL
—
AGILA B 1.2 - 1.2 LPG 16V (H08)

SUZUKI
—
SPLASH 1.2 - 1.2 VVT 16V (A5B412) - SWIFT IV 1.2 - 1.2 4X4 16V (FZ-NZ)

DESCRIPTION	P/N	CROSS REFERENCES				
		OE	RNZ	EK	AJ	PY
HEAD SET WITH MLS H.G	053596-1000	4709984 93194606	02-37660-01	047.260	52278300	
MLS H.G. 0.6MM	103596-5250	4708884 11141-73K00	61-37660-00	789.550	10190200	AH6920

*Find out our complete range: www.athena.eu | *Per ulteriori informazioni consultate il catalogo online nel nostro sito: www.athena.eu

053589-1000

OPEL - SUZUKI

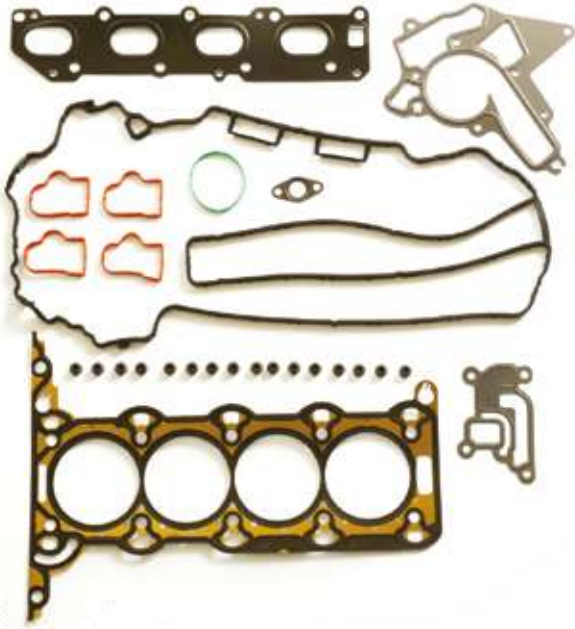

103581-3850



113575-8000



ENGINES* | MOTORI*

DISPLACEMENT
1.2-1.4 16V

—
Z12XE Until/Fino a 42-48000001
Z12XEP
Z14XEL - Z14XEP

MODELS* | MODELLI*

OPEL

—
AGILA A 1.2 16V - ASTRA H 1.2-1.4 16V - COMBO VAN 1.4 16V - CORSA C-D 1.2-1.4 16V - MERIVA A 1.4 16V - TIGRA TWINTOP 1.4 16V

SUZUKI

—
WAGON R 1.2 16V

DESCRIPTION	P/N	CROSS REFERENCES				
		OE	RNZ	EK	AJ	PY
UNIFIED HEAD SET WITH MLS H.G. (ORIGINAL PROD.)	053589-1000	1606247 1606278	02-36225-01	378.110 378.120	52261900 52254000	CH5031
MLS HEAD GASKET (ORIGINAL PROD.)	103581-3850	5607837 93177159	61-36225-00	808.134	52261900 52254000	AH5030
CYLINDER HEAD COVER	113575-8000	5607467	71-35888-00	104.110	11109400	JM5071

*Find out our complete range: www.athena.eu | *Per ulteriori informazioni consultate il catalogo online nel nostro sito: www.athena.eu

053589-1052

OPEL - SUZUKI

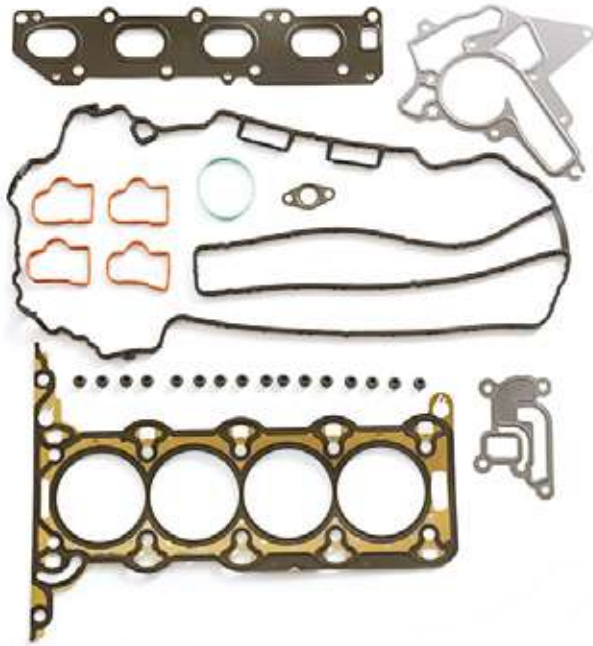

103581-5250



113575-8000



ENGINES* | MOTORI*

DISPLACEMENT
1.2-1.4 16V

—
Z12XE Until/Fino a 42-48000001
Z12XEP
Z14XEL - Z14XEP

MODELS* | MODELLI*

OPEL

—
AGILA A 1.2 16V - ASTRA H 1.2-1.4 16V - COMBO VAN 1.4 16V - CORSA C-D 1.2-1.4 16V - MERIVA A 1.4 16V - TIGRA TWINTOP 1.4 16V

SUZUKI

—
WAGON R 1.2 16V

DESCRIPTION	P/N	CROSS REFERENCES				
		OE	RNZ	EK	AJ	PY
HEAD SET - UNIFIED WITH MLS H.G (OUR PRODUCTION)	053589-1052 ^A	1606247 1606278	02-36225-01	378.110 378.120	52261900 52254000	CH5031
MLS HEAD GASKET	103581-5250 ^B	5607837 93177159	61-36225-00	808.134	52261900 52254000	AH5030
CYLINDER HEAD COVER	113575-8000	5607467	71-35888-00	104.110	11109400	JM5071

^A Interchangeable with p/n 053589-1000.

^B Interchangeable with p/n 103581-3850.

053589-5251

OPEL - SUZUKI

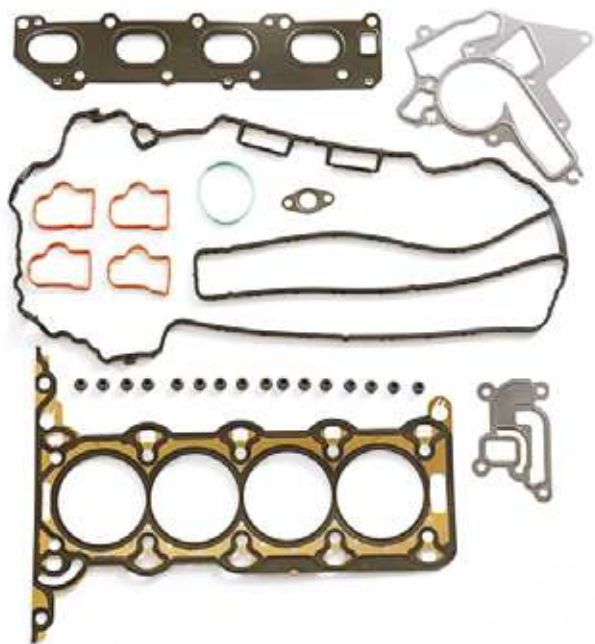

ENGINES* | MOTORI*

DISPLACEMENT
1.2-1.4 16V

—
Z12XE Until/Fino a 42-48000001
Z12XEP
Z14XEL - Z14XEP

MODELS* | MODELLI*

OPEL
—
AGILA A 1.2 16V - ASTRA H 1.2-1.4 16V - COMBO VAN 1.4 16V - CORSA C-D 1.2-1.4 16V - MERIVA A 1.4 16V - TIGRA TWINTOP 1.4 16V

SUZUKI
—
WAGON R 1.2 16V

DESCRIPTION	P/N	CROSS REFERENCES				
		OE	RNZ	EK	AJ	PY
UNIFIED HEAD SET WITH MLS H.G OVERSIZED + 0,25 MM	053589-5251					
MLS HEAD GASKET OVERSIZED + 0,25 MM	103581-5251		61-36225-10			
CYLINDER HEAD COVER	113575-8000	5607467	71-35888-00	104.110	11109400	JM5071

*Find out our complete range: www.athena.eu | *Per ulteriori informazioni consultate il catalogo online nel nostro sito: www.athena.eu

053599-1000

CHEVROLET - DAEWOO - OPEL

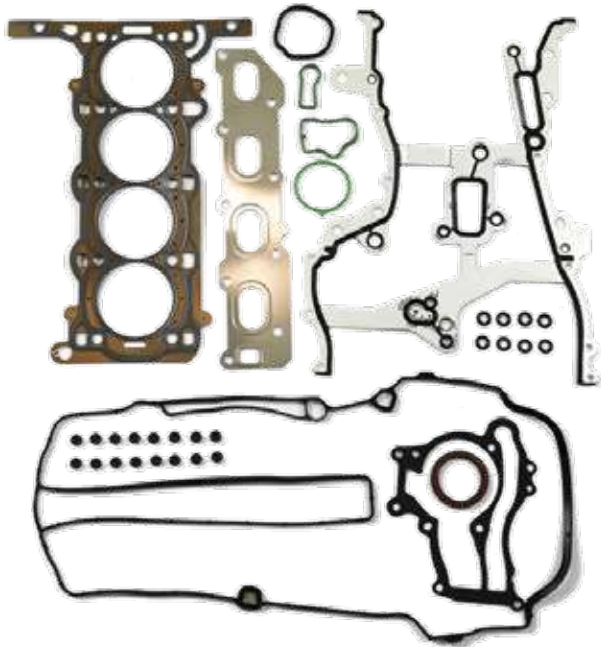

103599-3850



113599-8100

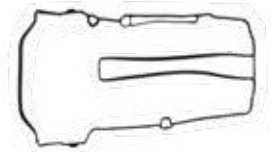

423599-8500



ENGINES* | MOTORI*

DISPLACEMENT
1.2-1.2 LPG-1.4 16V

A12XEL-A12XER
A14XEL-A14XER-B14XER

MODELS* | MODELLI*

CHEVROLET - DAEWOO

AVEO 1.2-1.2 LPG-1.4 16V - CRUZE 1.4 16V

OPEL

ADAM 1.2-1.4-1.4 LPG 16V - ASTRA J 1.4 16V - CORSA D 1.2-1.2 LPG - CORSA D VAN 1.2 16V - CORSA D 1.4-1.4 LPG - MERIVA B 1.4 16V

DESCRIPTION	P/N	CROSS REFERENCES				
		OE	RNZ	EK	AJ	PY
HEAD SET WITH MLS H.G (ORIGINAL PROD.) AND OIL SEALS	053599-1000	1606079	02-37875-04 + 71-40674-00	744.150	52347500	
MLS HEAD GASKET (ORIGINAL PROD.)	103599-3850	607161	61-37875-00	493.141		
CYLINDER HEAD COVER	113599-8100	642026	71-40674-00	691.370		JM7140
TIMING COVER GASKET	423599-8500	638130 55562793	71-40668-00	503.241		

053599-1052

CHEVROLET - DAEWOO - OPEL

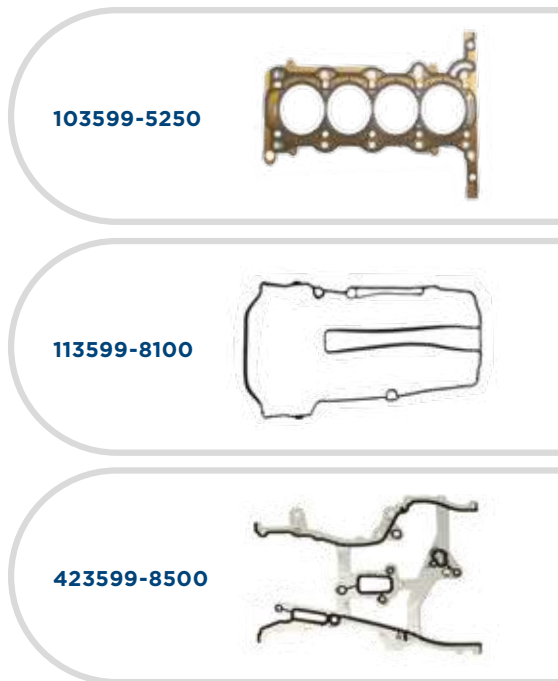
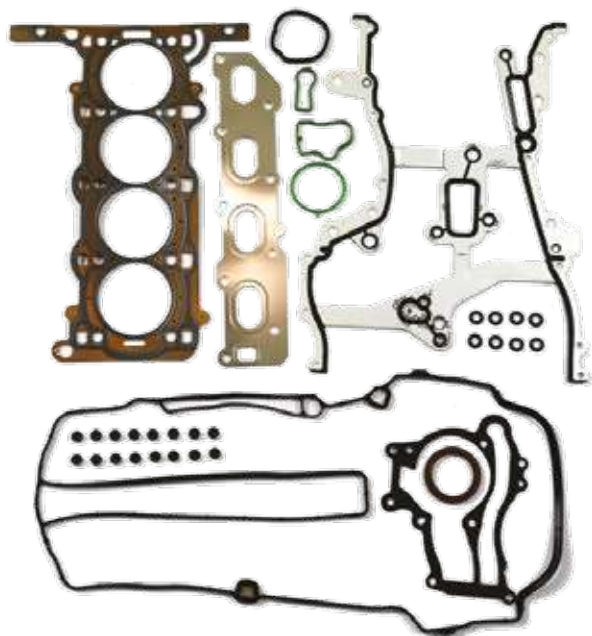

ENGINES* | MOTORI*

DISPLACEMENT
1.2-1.2 LPG-1.4 16V

A12XEL-A12XER
A14XEL-A14XER-B14XER

MODELS* | MODELLI*

CHEVROLET - DAEWOO

AVEO 1.2-1.2 LPG-1.4 16V - CRUZE 1.4 16V

OPEL

ADAM 1.2-1.4-1.4 LPG 16V - ASTRA J 1.4 16V - CORSA D 1.2-1.2 LPG - CORSA D VAN 1.2 16V - CORSA D 1.4-1.4 LPG - MERIVA B 1.4 16V

DESCRIPTION	P/N	CROSS REFERENCES				
		OE	RNZ	EK	AJ	PY
HEAD SET WITH MLS H.G (OUR PRODUCTION) AND OIL SEALS	053599-1052 ^A	1606079	02-37875-04 + 71-40674-00	744.150	52347500	
MLS HEAD GASKET	103599-5250	607161	61-37875-00	493.141		
CYLINDER HEAD COVER	113599-8100	642026	71-40674-00	691.370		JM7140
TIMING COVER GASKET	423599-8500	638130 55562793	71-40668-00	503.241		

^A Interchangeable with p/n 053599-1000.

058412-1000

CHEVROLET - DAEWOO - OPEL

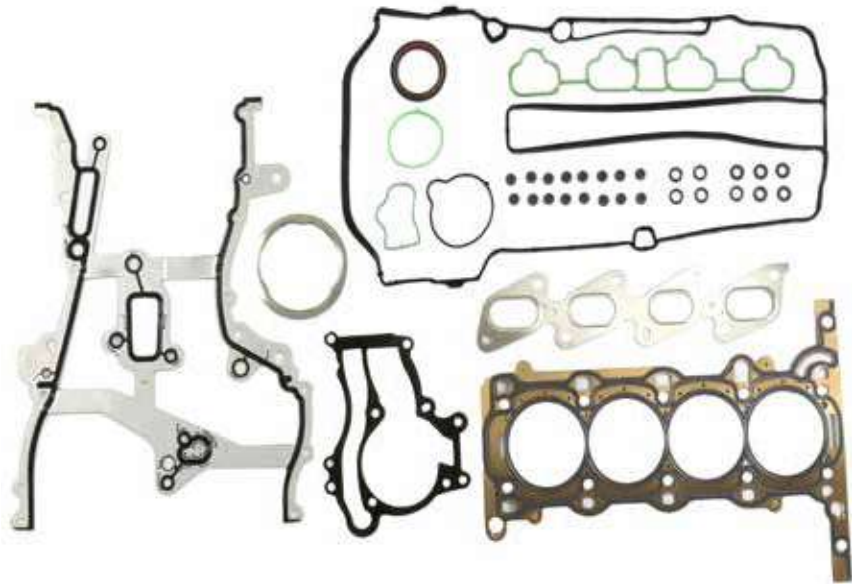

103599-3850



113599-8100

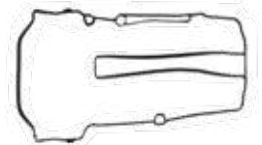

423599-8500



ENGINES* | MOTORI*

DISPLACEMENT
1.4T 16V
1.4 16V
1.4 AWD 16 V
1.4-T LPG 16V
 —
 A14NEL-NET
 B14NEL-NET

MODELS* | MODELLI*

CHEVROLET-DAEWOO
 —
 AVEO 1.4T 16V - CRUZE 1.4 16V - ORLANDO 1.4 16V - TRAX 1.4-1.4 AWD 16V

OPEL
 —
 ASTRA J 1.4-T LPG 16V-GH.G. 1.4 16V - CASCADA 1.4 16V - CORSA D 1.4 16V -
 INSIGNIA 1.4-1.4 LPG 16V - MERIVA B 1.4-1.4 LPG 16V - MOKKA 1.4 16V - ZAFIRA C
 1.4-1.4 LPG 16V

DESCRIPTION	P/N	CROSS REFERENCES				
		OE	RNZ	EK	AJ	PY
HEAD SET WITH MLS H.G (ORIGINAL PROD.) AND OIL SEALS	058412-1000	95507853 1629010	02-37875-03 + 71-40674-00	243.970	52365100	
MLS HEAD GASKET (ORIGINAL PROD.)	103599-3850	607161	61-37875-00	493.141		
CYLINDER HEAD COVER	113599-8100	642026	71-40674-00	691.370		JM7140
TIMING COVER GASKET	423599-8500	638130 55562793	71-40668-00	503.241		

*Find out our complete range: www.athena.eu | *Per ulteriori informazioni consultate il catalogo online nel nostro sito: www.athena.eu

058412-1052

CHEVROLET - DAEWOO - OPEL

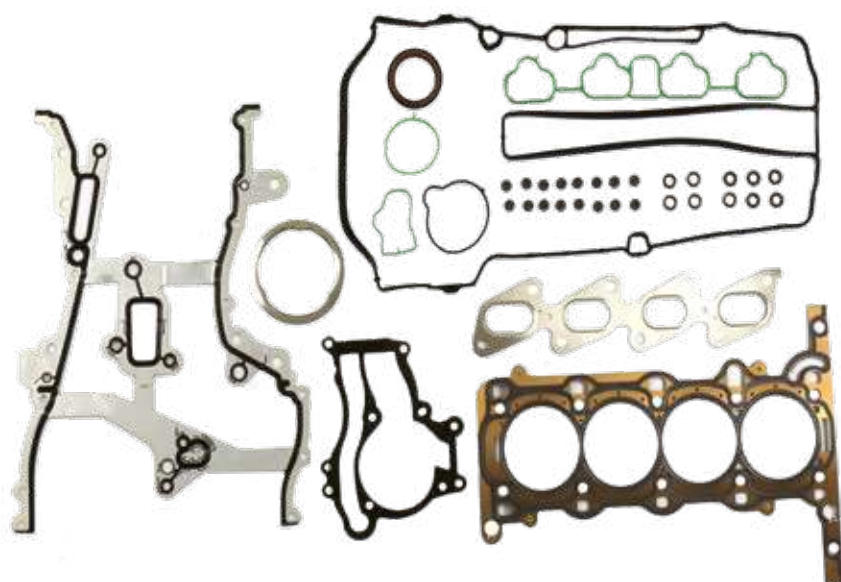

103599-5250



113599-8100

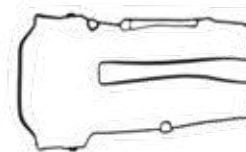

423599-8500



ENGINES* | MOTORI*

DISPLACEMENT
1.4T 16V
1.4 16V
1.4 AWD 16V
1.4-T LPG 16V

—
A14NEL-NET
B14NEL-NET

MODELS* | MODELLI*

CHEVROLET-DAEWOO

—
AVEO 1.4T 16V - CRUZE 1.4 16V - ORLANDO 1.4 16V - TRAX 1.4-1.4 AWD 16V

OPEL

—
ASTRA J 1.4-T LPG 16V-GH.G. 1.4 16V - CASCADA 1.4 16V - CORSA D 1.4 16V -
INSIGNIA 1.4-1.4 LPG 16V - MERIVA B 1.4-1.4 LPG 16V - MOKKA 1.4 16V - ZAFIRA C
1.4-1.4 LPG 16V

DESCRIPTION	P/N	CROSS REFERENCES				
		OE	RNZ	EK	AJ	PY
HEAD SET WITH MLS H.G (OUR PRODUCTION) AND OIL SEALS	058412-1052 ^A	95507853 1629010	02-37875-03 + 71-40674-00	243.970	52365100	
MLS HEAD GASKET (OUR PRODUCTION)	103599-5250	607161	61-37875-00	493.141		
CYLINDER HEAD COVER	113599-8100	642026	71-40674-00	691.370		JM7140
TIMING COVER GASKET	423599-8500	638130 55562793	71-40668-00	503.241		

^A Interchangeable with p/n 058412-1000

*Find out our complete range: www.athena.eu | *Per ulteriori informazioni consultate il catalogo online nel nostro sito: www.athena.eu

058416-5242

CHEVROLET - OPEL

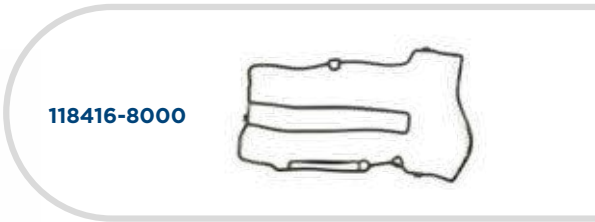
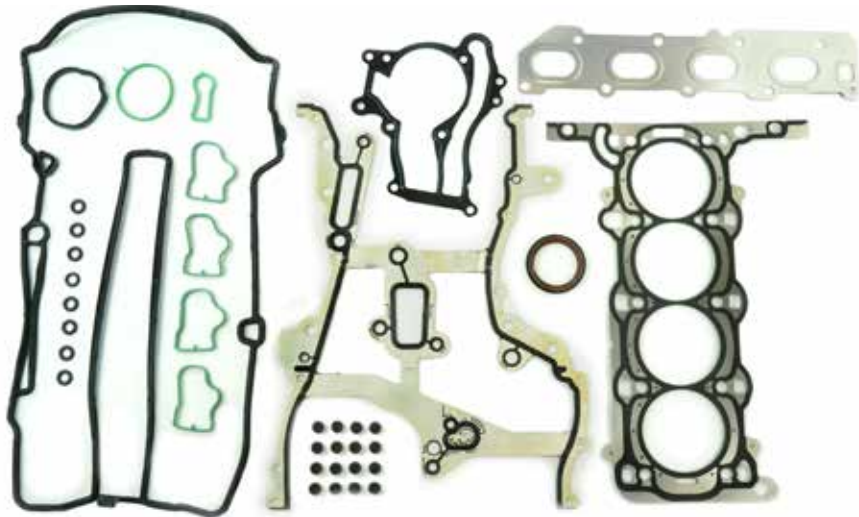

ENGINES* | MOTORI*

DISPLACEMENT
1.2 - 1.4 16V

—
LDD
A12XEL - A12XER - A14XEL - A14XER
B12XEL - B12XER - B14XEL - B14XEJ - B14XER

MODELS* | MODELLI*

CHEVROLET

—
AVEO 1.2-LPG - 1.4 16V - CRUZE 1.4 16V

OPEL

—
ADAM 1.2-1.4 16V - ASTRA J 1.4 16V - CORSA D 1.2-LPG-1.4 16V
CORSA E 1.2-1.4 16V - MERIVA B 1.4 16V

OPEL COMMERCIAL VEHICLES

—
CORSA D VAN 1.2 16V - CORSA E VAN 1.2 -1.4 16V

DESCRIPTION	P/N	CROSS REFERENCES				
		OE	RNZ	EK	AJ	PY
HEAD SET WITH MLS H.G 103599-5250	058416-5242 ^A	95519630	02-37875-04 + 71-42349-00	779.670		
CYLINDER HEAD COVER	118416-8000 ^B	638156	71-42349-00	773.410	11130800	JM7140

^A with timing cover gasket p/n 423599-8500

^B T-profile gasket

058417-5242

CHEVROLET - OPEL

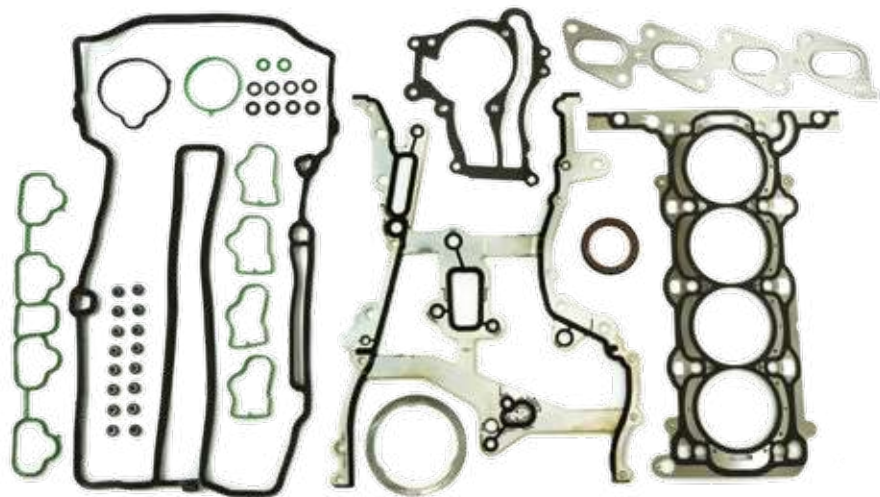

ENGINES* | MOTORI*

DISPLACEMENT
1.4 16V

—
LUJ - LUV
A14NEL - A14NET - B14NEH - B14NEJ - B14NEL - B14NET

MODELS* | MODELLI*

CHEVROLET
—

TRAX 1.4-LPG 1.4 TURBO 16V

OPEL
—

ADAM 1.4 TURBO 16V - ASTRA J 1.4 LPG TURBO 16V - CASCADA - CORSA D - E -
INSIGNIA A - MERIVA B 1.4 TURBO 16V - MOKKA - MOKKA X 1.4-LPG 1.4 TURBO
16V

DESCRIPTION	P/N	CROSS REFERENCES				
		OE	RNZ	EK	AJ	PY
HEAD SET WITH MLS H.G 103599-5250	058417-5242 ^A	1629142 / 95519632	02-37875-03 + 71-42349-00	793.390		
CYLINDER HEAD COVER	118416-8000 ^B	638156	71-42349-00	773.410	11130800	JM7140

^A with timing cover gasket p/n 423599-8500

^B T-profile gasket

053570-1052

OPEL

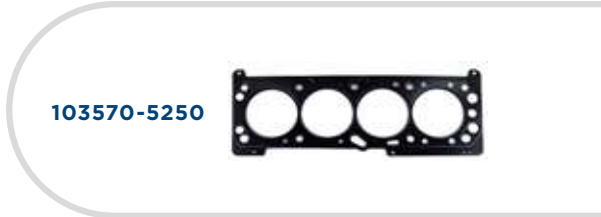

ENGINES* | MOTORI*

DISPLACEMENT
1.4 16V
—
Z14XE

MODELS* | MODELLI*

OPEL
—
ASTRA G 1.4i 16V - CORSA C 1.4i 16V - ZAFIRA A 1.4i 16V

DESCRIPTION	P/N	CROSS REFERENCES				
		OE	RNZ	EK	AJ	PY
HEAD SET WITH MLS H.G AND OIL SEALS	053570-1052	1606097	02-34235-01	808.170	52203900	CB5360
MLS HEAD GASKET	103570-5250	607410	61-34235-00	239.394	10005900	AB5360

*Find out our complete range: www.athena.eu | *Per ulteriori informazioni consultate il catalogo online nel nostro sito: www.athena.eu

053571-1052

OPEL

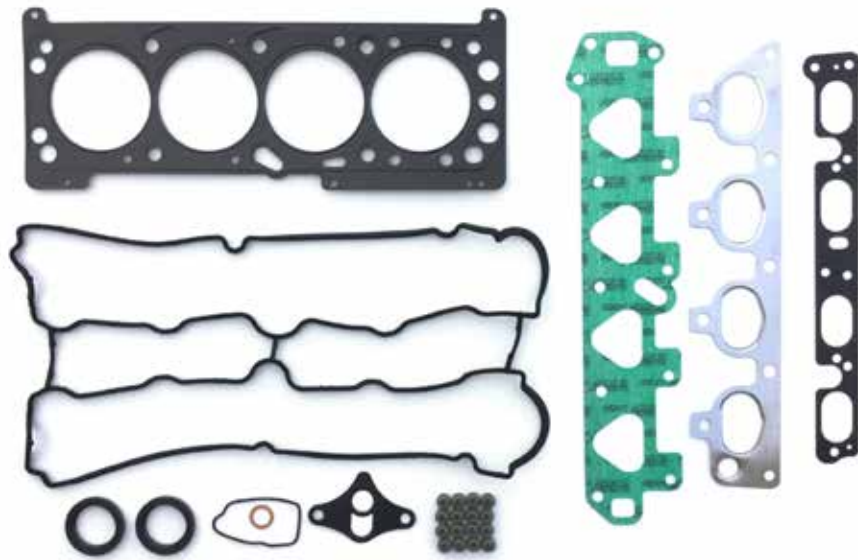

103571-5250



ENGINES* | MOTORI*

DISPLACEMENT
1.6 16V

Z16XE - Z16YNG - Y16XE - Y16YNG

MODELS* | MODELLI*

OPEL

ASTRA G - COMBO C - CORSA C - MERIVA A 1.6 16V - VECTRA B-C - ZAFIRA A-B 1.6 16V

DESCRIPTION	P/N	CROSS REFERENCES				
		OE	RNZ	EK	AJ	PY
HEAD SET WITH MLS H.G. AND OIL SEALS	053571-1052	1606130	02-34900-01	061.430	52204000	CB5540
MLS HEAD GASKET	103571-5250	607407 5607865	61-34900-00	239.384	10194400	AB5540

*Find out our complete range: www.athena.eu | *Per ulteriori informazioni consultate il catalogo online nel nostro sito: www.athena.eu

053586-1052

OPEL - FIAT GROUP

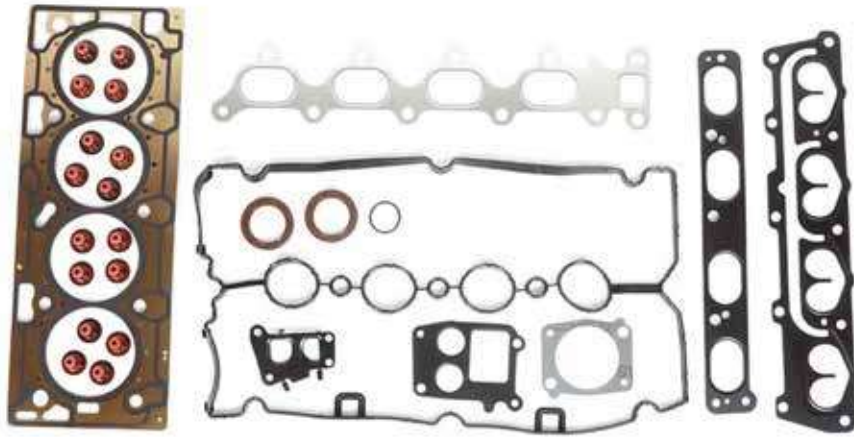

053586-1000



103586-3850



103586-5250



ENGINES* | MOTORI*

DISPLACEMENT
1.6 16V

192 B3.000 (FIAT) - Z16XEP (OPEL)

MODELS* | MODELLI*

OPEL

ASTRA G - H 1.6i 16V - MERIVA A - VECTRA C ZAFIRA B 1.6i 16V - ASTRA G - H 1.6i 16V

FIAT

STILO - STILO MULTI WAGON 1.6 16V

DESCRIPTION	P/N	CROSS REFERENCES				
		OE	RNZ	EK	AJ	PY
HEAD SET WITH MLS H.G AND OIL SEALS	053586-1052	1606221	02-36025-01	388.210	52254100	CE5930
HEAD SET WITH MLS H.G. (ORIGINAL PROD.) AND OIL SEALS	053586-1000	1606221	02-36025-01	388.210	52254100	CE5930
MLS HEAD GASKET ORIGINAL	103586-3850	56 07 863	61-36025-00	808.524	10161200	AE5930
MLS HEAD GASKET	103586-5250	56 07 863	61-36025-00	808.524	10161200	AE5930

*Find out our complete range: www.athena.eu | *Per ulteriori informazioni consultate il catalogo online nel nostro sito: www.athena.eu

053591-1052

OPEL

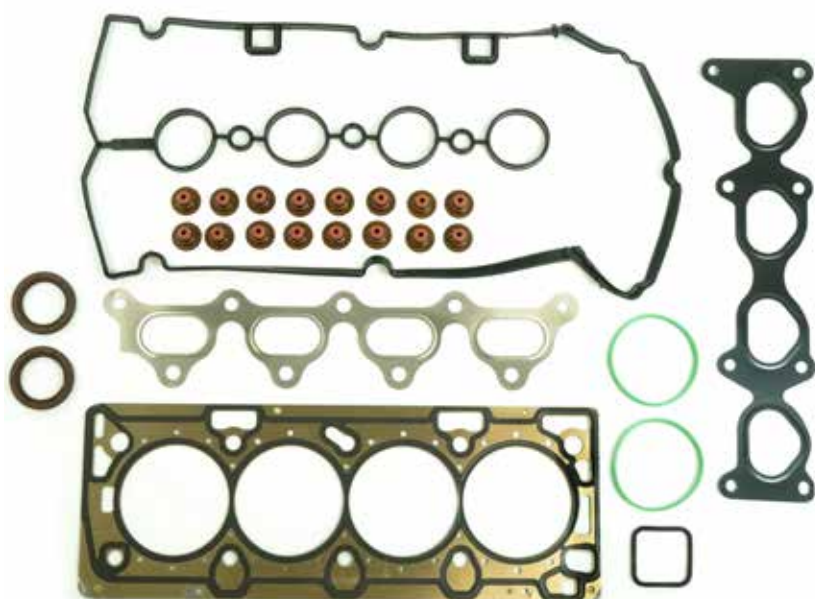

ENGINES* | MOTORI*

DISPLACEMENT
1.6 TURBO 16V

A16LEL - LER - LES - LET - XNT
Z16LEL - LER - LET - XNT

MODELS* | MODELLI*

OPEL

ASTRA H - J 1.6T - GH.G. 1.6T
CORSA D - INSIGNIA A - MERIVA 1.6T - ZAFIRA B - TOURER 1.6 CNG

DESCRIPTION	P/N	CROSS REFERENCES				
		OE	RNZ	EK	AJ	PY
HEAD SET WITH MLS H.G AND OIL SEALS	053591-1052 ^A	1606535 / 93186907	02-37240-02	354.000	52262100	CH5241
MLS HEAD GASKET	103591-5250 ^B	5607895	61-37240-00	076.892	10175200	AH5240

^A Interchangeable with p/n 053591-1000

^B Interchangeable with p/n 103591-3850

053592-1000

**FIAT GROUP - CHEVROLET
OPEL**



103591-3850



113591-8000

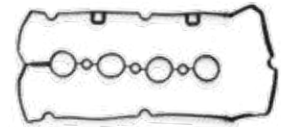

ENGINES* | MOTORI*

DISPLACEMENT

1.8 MPI 16V
1.8-LPG 16V
1.8 AWD 16V
1.8-GH.G. 16V

939A4.000
2H0-F18 D4
A18XER-A18XEL-Z18XER

MODELS* | MODELLI*

ALFA ROMEO

159 SW 1.8 MPI 16V

CHEVROLET

CRUZE-ORLANDO J 1.8-LPG 16V - TRAX 1.8 AWD 16V

FIAT

NUOVA CROMA 1.8 16V

OPEL

ASTRA H-J 1.8-GH.G. 16V - INSIGNIA 1.8 16V - MOKKA 1.8 16V - SIGNUM 1.8 16V - VECTRA C-ZAFIRA B-C 1.8 16V

DESCRIPTION	P/N	CROSS REFERENCES				
		OE	RNZ	EK	AJ	PY
HEAD SET WITH MLS H.G (ORIGINAL PROD.) AND OIL SEALS	053592-1000	1606537 93186911	02-37240-01	354.010	52255300	CH5240
MLS HEAD GASKET (ORIGINAL PROD.)	103591-3850	71744395 (AR-FIAT) 5607895 (OPEL)	61-37240-00	076.892	10175200	AH5240
CYLINDER HEAD COVER	113591-8000	55354237 (AR-FIAT) 5607980 (OPEL)	71-38166-00	354.030	11110300	JM7103

053592-1052

FIAT GROUP - CHEVROLET OPEL



103591-5250



113591-8000

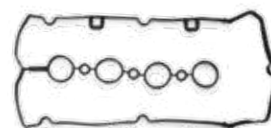

ENGINES* | MOTORI*

DISPLACEMENT

1.8 MPI 16V

1.8-LPG 16V

1.8 AWD 16V

1.8-GH.G. 16V

—

939A4.000

2HO-F18 D4

A18XER-A18XEL-Z18XER

MODELS* | MODELLI*

ALFA ROMEO

—
159 SW 1.8 MPI 16V

CHEVROLET

—
CRUZE-ORLANDO J 1.8-LPG 16V - TRAX 1.8 AWD 16V

FIAT

—
NUOVA CROMA 1.8 16V

OPEL

—
ASTRA H-J 1.8-GH.G. 16V - INSIGNIA 1.8 16V - MOKKA 1.8 16V - SIGNUM 1.8 16V -
VECTRA C-ZAFIRA B-C 1.8 16V

DESCRIPTION	P/N	CROSS REFERENCES				
		OE	RNZ	EK	AJ	PY
HEAD SET WITH MLS H.G (OUR PRODUCTION) AND OIL SEALS	053592-1052 ^A	1606537 93186911	02-37240-01	354.010	52255300	CH5240
MLS HEAD GASKET (OUR PRODUCTION)	103591-5250	71744395 (AR-FIAT) 5607895 (OPEL)	61-37240-00	076.892	10175200	AH5240
CYLINDER HEAD COVER	113591-8000	55354237 (AR-FIAT) 5607980 (OPEL)	71-38166-00	354.030	11110300	JM7103

^A Interchangeable with p/n 053592-1000.

*Find out our complete range: www.athena.eu | *Per ulteriori informazioni consultate il catalogo online nel nostro sito: www.athena.eu

043587-1000
HONDA - OPEL



113587-8000

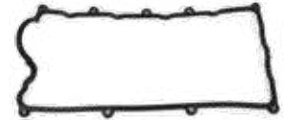

ENGINES* | MOTORI*

DISPLACEMENT
1.7 DTI-CDTI 16V
—
Z17DTH - Z17DTL
4EE2 (HONDA)

MODELS* | MODELLI*

HONDA

—
CIVIC VII 1.7 CDTI (EU-EP-EV)

OPEL - VAUXHALL

—
ASTRA G 1.7 CDTI 16V - ASTRA H 1.7 GH.G. CDTI 16V - COMBO C 1.7 CDTI 16V -
CORSA C 1.7 DTI-CDTI 16V - MERIVA A 1.7 CDTI 16V

DESCRIPTION	P/N	CROSS REFERENCES				
		OE	RNZ	EK	AJ	PY
HEAD SET WITHOUT H.G. WITH OIL SEALS	043587-1000		02-36081-01	486.090	53025700	CE5523
CYLINDER HEAD COVER	113587-8000	12341PLZD00 (HONDA) 5607815 (OPEL)	71-36081-00	461.700	11123600	JM5198

103588-5251

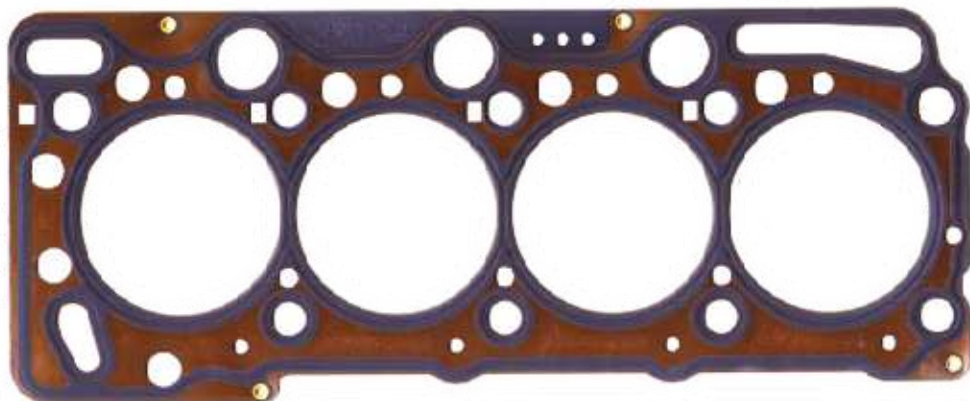
CHEVROLET - HONDA - OPEL**ENGINES* | MOTORI***

DISPLACEMENT
1.7 DTI 16V
1.7 CDTI 16V
 —
 Z17DTH - Z17DTL

MODELS* | MODELLI***CHEVROLET**

—
 CORSA PICK-UP 1.7 DTI 16V

HONDA

—
 CIVIC VII (EP-EV) 1.7 CDTI 16V

OPEL - VAUXHALL

—
 ASTRA G 1.7 CDTI 16V - ASTRA H 1.7 GH.G. CDTI 16V - COMBO C 1.7 CDTI 16V -
 CORSA C 1.7 DTI-CDTI 16V
 MERIVA A 1.7 CDTI 16V -

DESCRIPTION	P/N	CROSS REFERENCES				
		OE	RNZ	EK	AJ	PY
MLS HEAD GASKET TH. 1,45 MM 1 HOLE	103588-5251	5607872- 97370797	61-53245-00	809.710	10161300	AE5520- AG9840
MLS HEAD GASKET TH. 1,50 MM 2 HOLES	103588-5252	5607873- 97370798	61-53245-10	809.750	10161310	AE5530- AG9850
MLS HEAD GASKET TH. 1,55 MM 3 HOLES	103588-5253	5607874- 97370799	61-53245-20	809.760	10161320	AE5540- AG9860

*Find out our complete range: www.athena.eu | *Per ulteriori informazioni consultate il catalogo online nel nostro sito: www.athena.eu

043594-1000

OPEL

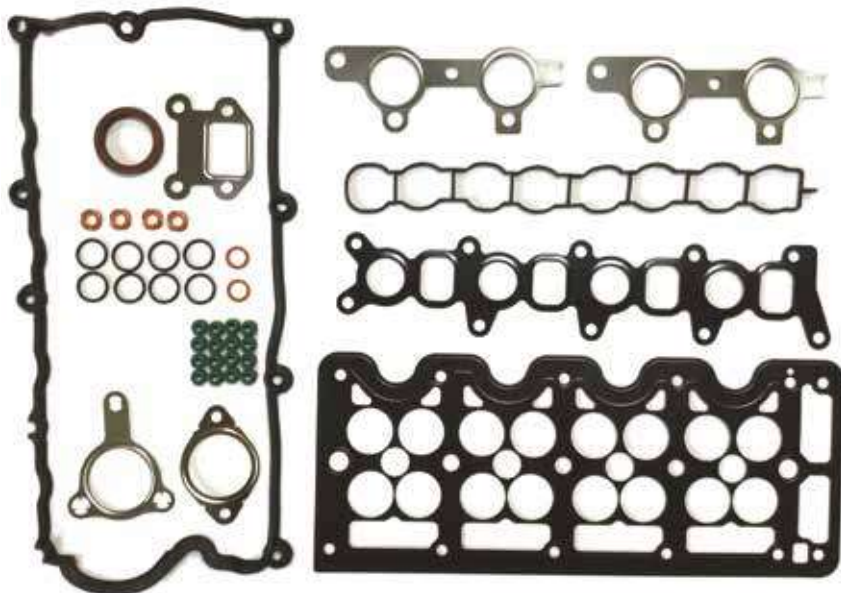

ENGINES* | MOTORI*

DISPLACEMENT
1.7 CDTI 16V

—
A17DH,G.-E-F-J-L-R-S
Z17DTJ-R-S

MODELS* | MODELLI*

OPEL - VAUXHALL

—
ASTRA H 1.7 CDTI-GH.G. 1.7 CDTI 16V - ASTRA J 1.7 CDTI-GH.G. 1.7 CDTI 16V -
CORSA D 1.7 CDTI 16V - MERIVA A-B 1.7 CDTI 16V - MOKKA 1.7 CDTI- 1.7 CDTI 4X4
16V - ZAFIRA B 1.7 CDTI 16V

OPEL COMMERCIALI

—
ASTRA H VAN 1.7 CDTI 16V - ZAFIRA B VAN 1.7 CDTI 16V

DESCRIPTION	P/N	CROSS REFERENCES				
		OE	RNZ	EK	AJ	PY
HEAD SET WITHOUT H.G. WITH OIL SEALS	043594-1000		02-38168-01	691.930	53031100	CH6910
CYLINDER HEAD COVER	113594-8000	5607252 98014758	71-38168-00	477.390	11119000	JM7116

*Find out our complete range: www.athena.eu | *Per ulteriori informazioni consultate il catalogo online nel nostro sito: www.athena.eu

103594-5251

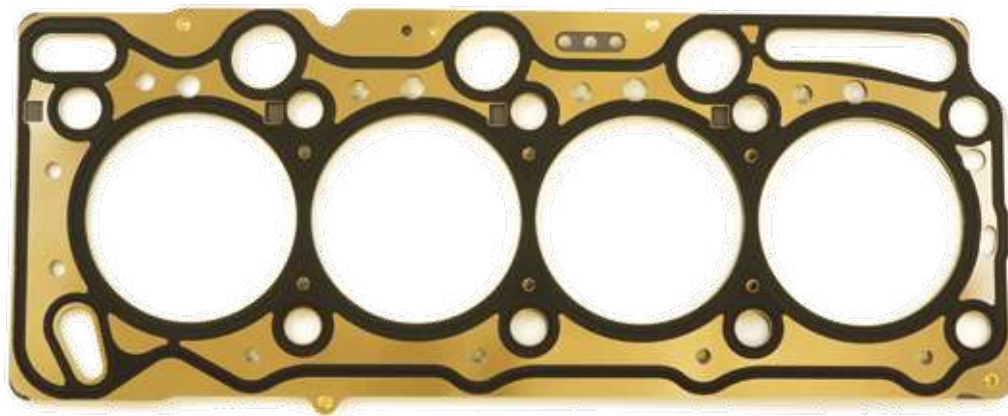
CHEVROLET - OPEL**ENGINES* | MOTORI*****DISPLACEMENT**
1.7 CDTi 16V—
A17DT - DH.G.-E-F-I-J-L-N-R-S Z17DTJ-DTR**MODELS* | MODELLI*****CHEVROLET**—
CRUZE (J300-5-8) - TRAX 1.7 TD 16V**OPEL**—
ASTRA H-J - CORSA D - MERIVA A-B - MOKKA-X - ZAFIRA B 1.7 CDTi 16V

DESCRIPTION	P/N	CROSS REFERENCES				
		OE	RNZ	EK	AJ	PY
MLS HEAD GASKET TH. 0,95 MM - 1 NOTCH	103594-5251	5607634 / 97376212	61-37235-00	158.352	10179600	AH6910
MLS HEAD GASKET TH. 1 MM - 2 NOTCHES	103594-5252	5607635 / 97376213	61-37235-10	158.382	10179610	
MLS HEAD GASKET TH. 1,05 MM - 3 NOTCHES	103594-5253	5607636 / 97376214	61-37235-20	158.412	10179620	

*Find out our complete range: www.athena.eu | *Per ulteriori informazioni consultate il catalogo online nel nostro sito: www.athena.eu

048413-1099

OPEL - CHEVROLET



ENGINES* | MOTORI*

DISPLACEMENT
2.0 DT 16V

—
A20 DT - DH.G. - DTE - DTH - DTJ - DTL - DTR
Y20 DTJ - Z 20 DTJ - LBS

MODELS* | MODELLI*

OPEL

—
ASTRA J - J GH.G. 2.0 BITURBO CDTI 16V - CASCADA 2.0 CDTI
INSIGNIA 2.0 BITURBO CDTI 16V - ZAFIRA TOURER C 2.0 BITURBO CDTI 16V - SAAB
9.5 2.0 TTID

CHEVROLET

—
MALIBU' 2.0 D 16V

DESCRIPTION	P/N	CROSS REFERENCES				
		OE	RNZ	EK	AJ	PY
HEAD SET WITHOUT H.G. WITH OIL SEALS	048413-1099		02-39354-01	891.830	53039100	

*Find out our complete range: www.athena.eu | *Per ulteriori informazioni consultate il catalogo online nel nostro sito: www.athena.eu

043567-1000

CYLINDER HEAD GASKET SET - KIT GUARNIZIONI TESTATA OPEL - SAAB

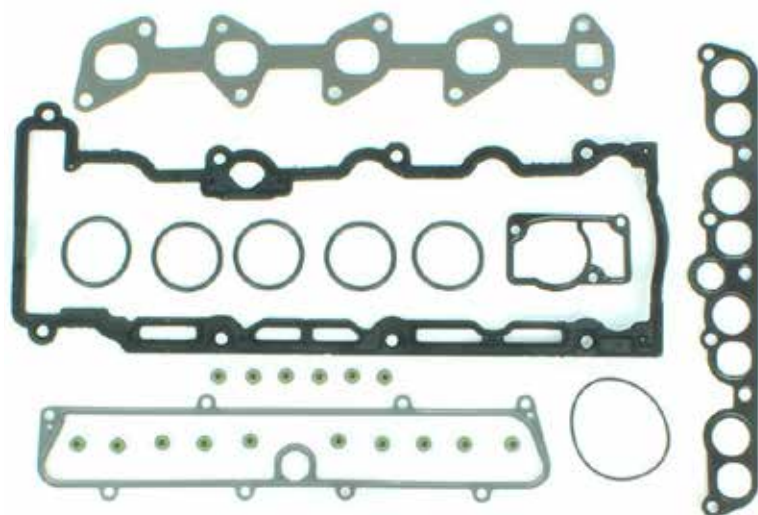

113567-8500

ENGINES* | MOTORI*

DISPLACEMENT | CILINDRATA

2.0 DS - 2.2 DS 16V

CODE | CODICE

X20DTH - X20DTL - X22DTH - Y20DTL - X22DTH - Y22DTH - Y22DTR - D223L

MODELS* | MODELLI*

OPEL

ASTRA G (F70-T98) 2.0 DI - DTI 16V - ASTRA G (T98) 2.2 DTI 16V
FRONTERA B (J99) 2.2 DTI 16V
OMEGA B (V94) 2.0 DTI 16V - OMEGA B (V94) 2.2 DTI 16V
SIGNUM 2 (Z03) 2.0 DTI 16V - SIGNUM 2 (Z03) 2.2 DTI 16V
SINTRA (APV) 2.2 DTI 16V
VECTRA B (J96) 2.0 DTI 16V - VECTRA B (J96) 2.2 DTI 16V
VECTRA C - GTS (Z02) 2.0 DTI 16V - VECTRA C-GTS (Z02) 2.2 DTI 16V
ZAFIRA A MPV (T98) 2.0 DTI 16V - ZAFIRA A MPV (T98) 2.2 DTI 16V

SAAB

9-3 (YS3D) 2.2 TID 16V - 9-5 (YS3E) 2.2 TID 16V

DESCRIPTION DESCRIZIONE	CROSS REFERENCES CORRISPONDENZE						
	P/N	GA	OE	RNZ	EK	AJ	PY
CYLINDER HEAD GASKET SET, WITHOUT H.G. KIT GUARNIZIONI TESTATA, SENZA T.C.	043567-1000			02-34277-01	023.370	53060700	CB5670
CYLINDER HEAD COVER GASKET GUARNIZIONE COPRITESTATA	113567-8500		5607442 90571911	71-34277-00	864.310	11063600	JM5159

*Find out our complete range: www.athena.eu | *Per ulteriori informazioni consultate il catalogo online nel nostro sito: www.athena.eu

103567-5251

CYLINDER HEAD GASKET - GUARNIZIONE TESTATA
OPEL - SAAB



ENGINES* | MOTORI*

DISPLACEMENT | CILINDRATA

2.0 DS - 2.2 DS 16V

CODE | CODICE

X20DTH - X20DTL - X22DTH - Y20DTL - X22DTH - Y22DTH - Y22DTR - D223L

MODELS* | MODELLI*

OPEL

ASTRA G (F70-T98) 2.0 DI / DTI 16V - ASTRA G (T98) 2.2 DTI 16V
FRONTERA B (U99) 2.2 DTI 16V
OMEGA B (V94) 2.0 DTI 16V - OMEGA B (V94) 2.2 DTI 16V
SIGNUM 2 (Z03) 2.0 DTI 16V - SIGNUM 2 (Z03) 2.2 DTI 16V
SINTRA (APV) 2.2 DTI 16V
VECTRA B (J96) 2.0 DTI 16V - VECTRA B (J96) 2.2 DTI 16V
VECTRA C - GTS (Z02) 2.0 DTI 16V - VECTRA C - GTS (Z02) 2.2 DTI 16V
ZAFIRA A MPV (T98) 2.0 DTI 16V - ZAFIRA A MPV (T98) 2.2 DTI 16V

SAAB

9-3 (YS3D) 2.2 TID 16V - 9-5 (YS3E) 2.2 TID 16V

DESCRIPTION DESCRIZIONE	P/N		CROSS REFERENCES CORRISPONDENZE			
	GA	OE	RNZ	EK	AJ	PY
CYLINDER HEAD GASKET, MLS 1,30 mm, 1 NOTCH GUARNIZIONE TESTATA, MLS 1,30 mm, 1 TACCA	103567-5251 ^{*A}	5607422 5607855 90540460	61-33820-00	146.818	10100910	AB5670
CYLINDER HEAD GASKET, MLS 1,40 mm, 2 NOTCHES GUARNIZIONE TESTATA, MLS 1,40 mm, 2 TACCHE	103567-5252 ^{*B}	5607423 5607856 90540461	61-33820-10	146.828	10100920	AB5680

^{*A} **Cancels and supercedes 103567-3851** - Annulla e sostituisce 103567-3851

^{*B} **Cancels and supercedes 103567-3852** - Annulla e sostituisce 103567-3852

048414-1099

OPEL

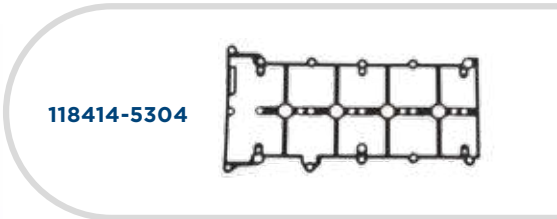

118414-5304

ENGINES* | MOTORI*

DISPLACEMENT
1.9 CDTI 16V

—
Z19DTH - Z19DTJ
From/Dal 2004
From engine/Dal motore 17180895

MODELS* | MODELLI*

OPEL

—
ASTRA H 1.9 CDTI 16V - SIGNUM 1.9 CDTI 16V - VECTRA C 1.9 CDTI 16V - ZAFIRA 1.9 CDTI 16V

VAUXHALL

—
ASTRA MK V 1.9 CDTI 16V - SIGNUM 1.9 CDTI 16V - VECTRA MK II 1.9 CDTI 16V - ZAFIRA MK II 1.9 CDTI 16V

DESCRIPTION	P/N	CROSS REFERENCES				
		OE	RNZ	EK	AJ	PY
HEAD SET WITHOUT H.G. WITH OIL SEALS	048414-1099	6606044-93196171	02-41094-01	574.240		
CYLINDER HEAD COVER	118414-5304	5607273-55566654	71-41094-00	567.610		

*Find out our complete range: www.athena.eu | *Per ulteriori informazioni consultate il catalogo online nel nostro sito: www.athena.eu

053689-1000

**DAIHATSU - PSA GROUP
SUBARU - TOYOTA**

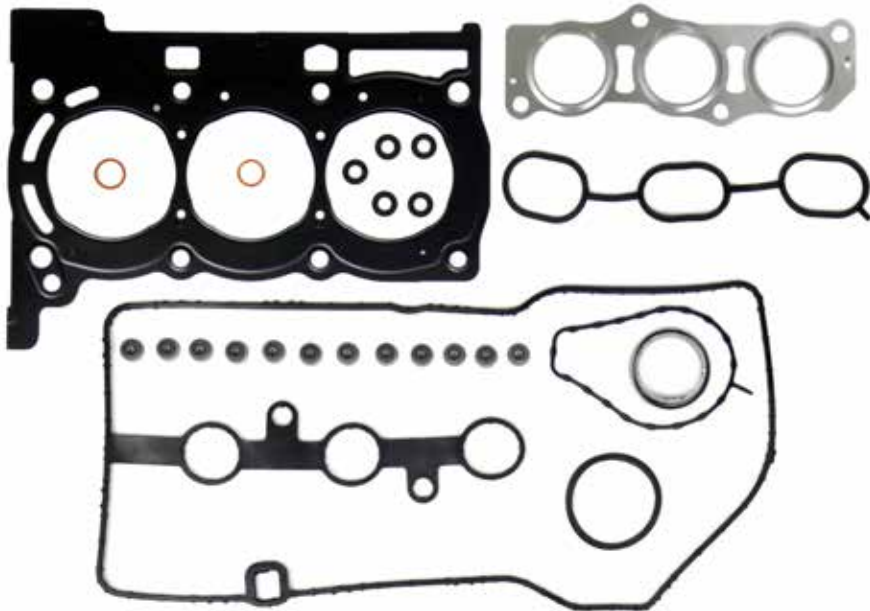

ENGINES* | MOTORI*

DISPLACEMENT
1.0i 12V
—
1KR-FE

MODELS* | MODELLI*

PSA GROUP

—
CITROEN C1 1.0i 12V - PEUGEOT 107 1.0i 12V

DAIHATSU

—
CUORE VIII - SIRION 1.0i 12V

SUBARU

—
JUSTY IV 1.0i 12V

TOYOTA

—
AYGO - IQ - PASEO - YARIS 1.0i 12V

DESCRIPTION	P/N	CROSS REFERENCES				
		OE	RNZ	EK	AJ	PY
HEAD SET WITH MLS H.G	053689-1000	0197.AT (PSA) 04112-0Q020 (TOYOTA)	02-53425-01	687.800	52238900	CG9310

*Find out our complete range: www.athena.eu | *Per ulteriori informazioni consultate il catalogo online nel nostro sito: www.athena.eu

053609-1019

CYLINDER HEAD GASKET SET - KIT GUARNIZIONI TESTATA PSA GROUP



103642-1912



113641-8000



EXPERT'S NOTE - NOTA DELL'ESPERTO

Cylinder head gasket with rubber-metal insert.
Guarnizione testata con inserto gomma-metallo.

ENGINES* | MOTORI*

DISPLACEMENT | CILINDRATA

1.1 8V - 1.3 8V - 1.4 8V

CODE | CODICE

H1A - H1B - HAZ (TU1CP) - HDZ (TU1M) Model year to/Anno motore da: 09.1996 Engine code/Codice motore: TU1M
K1B - K1D - K1F - K1G - K1H (TU3A) - K2A - K2B - K3A - K5A - KAY (TU3CP) - KAZ
KDX (TU3M/Z) - KDX (TU3MC) - KDY (TU3M) - KDZ (TU3M/Z) - KFT (TU3A)
KFT (TU3AE5) - KFV (TU3A) - KFV (TU3JP) - KFW (TU3A) - KFW (TU3JP)
KFX (TU3A) - KFX (TU3JP) - M4A - TU24 - TU32

MODELS* | MODELLI*

CITROEN

AX II 1.1 8V - AX SPORT 1.3 8V - AX 14 1.4 8V
BERLINGO 1.4 8V
BX 1.1 8V - BX 1.4 8V - C15E 1.1 8V - C15E 1.4 8V
C2 1.4 8V - C3 1.1 41 8V - C3 PRURIEL 1.4 8V
SAXO 1.1 8V - SAXO 1.4 8V - XSARA 1.4 8V - ZN 1.1 8V - ZN 1.4 8V

PEUGEOT

106 I - 106 II 1.4 8V - 1007 1.4 8V
205 I - 205 II 1.4 8V - 206 1.41 8V - 206+ 1.41 8V
306 1.4 8V - 307 1.4 8V - 309 I - 309 II 1.4 8V - 405 II 1.4 8V
PARTNER 1.4 8V - PARTNER 1.4 8V BIFUEL

DESCRIPTION DESCRIZIONE	P/N		CROSS REFERENCES CORRISPONDENZE			
	GA	OE	RNZ	EK	AJ	PY
CYLINDER HEAD GASKET SET, WITH H.G., WITH OIL SEALS KIT GUARNIZIONI TESTATA, CON T.C., CON PARAOLI	053609-1019	0197.H8 + 0342.E0 (4X) + 0342.E1 + 0209.CJ	02-31200-01			
CYLINDER HEAD GASKET, COMPOSITE MATERIAL GUARNIZIONE TESTATA IN MATERIALE COMPOSITO	103642-1912	0209.CJ 97520616	61-33715-00		10155600	AD5701
CYLINDER HEAD COVER GASKET GUARNIZIONE COPRITESTATA	113641-8000	0209.54 97523053	71-31146-00	776.416	11023900	JN658

*Find out our complete range: www.athena.eu | *Per ulteriori informazioni consultate il catalogo online nel nostro sito: www.athena.eu

052332-1019

CYLINDER HEAD GASKET SET - KIT GUARNIZIONI TESTATA PSA GROUP



102332-1913



113641-8000



EXPERT'S NOTE - NOTA DELL'ESPERTO

Cylinder head gasket without rubber-metal insert.
Guarnizione testata senza inserto gomma-metallo.

ENGINES* | MOTORI*

DISPLACEMENT | CILINDRATA

1.1 8V - 1.3 8V - 1.4 8V

CODE | CODICE

H1A - H1B - HAZ (TU1CP) - HDZ (TU1M) Model year to/Anno modello dal: 09.1996 Engine Code/Codice motore: TU1M
K1B - K1D - K1F - K1G - K1H (TU3A) - K2A - K2B - K3A - K5A - KAY (TU3CP) - KAZ
KDX (TU3M/Z) - KDX (TU3MC) - KDY (TU3M) - KDZ (TU3M/Z) - KFT (TU3A)
KFT (TU3AE5) - KFX (TU3A) - KFX (TU3JP) - KFW (TU3A) - KFW (TU3JP)
KFX (TU3A) - KFX (TU3JP) - M4A - TU24 - TU32

MODELS* | MODELLI*

CITROEN

AX 11.1 8V - AX SPORT 1.3 8V - AX 14 1.4 8V
BERLINGO 1.4 8V
BX 1.1 8V - BX 1.4 8V - C15E 1.1 8V - C15E 1.4 8V
C2 1.4 8V - C3 1.1 41 8V - C3 PLURIEL 1.4 8V
SAXO 1.1 8V - SAXO 1.4 8V - XSARA 1.4 8V - ZN 1.1 8V - ZN 1.4 8V

PEUGEOT

A106 I - 106 II 1.4 8V - 1007 1.4 8V
205 I - 205 II 1.4 8V - 206 1.4 8V - 206+ 1.4 8V
306 1.4 8V - 307 1.4 8V - 309 I - 309 II 1.4 8V - 405 II 1.4 8V
PARTNER 1.4 8V - PARTNER 1.4 8V BIFUEL

DESCRIPTION DESCRIZIONE	P/N					
	GA	OE	RNZ	EK	AJ	PY
CYLINDER HEAD GASKET SET, WITH H.G., WITH OIL SEALS KIT GUARNIZIONI TESTATA, CON T.C., CON PARAOLI	052332-1019			529.060		
CYLINDER HEAD GASKET, COMPOSITE MATERIAL GUARNIZIONE TESTATA IN MATERIALE COMPOSITO	102332-1913			984.136		
CYLINDER HEAD COVER GASKET GUARNIZIONE COPRITESTATA	113641-8000	0209.54 97523053	71-31146-00	776.416	11023900	JN658

*Find out our complete range: www.athena.eu | *Per ulteriori informazioni consultate il catalogo online nel nostro sito: www.athena.eu

043609-1099

CYLINDER HEAD GASKET SET - KIT GUARNIZIONI TESTATA PSA GROUP



113641-8000



ENGINES* | MOTORI*

DISPLACEMENT | CILINDRATA

1.0 8V - 1.1 8V - 1.3 8V - 1.4 8V

CODE | CODICE

C1A (TU9/K) - C1B (TU9/W) - C3A - CDY (TU9M) - CDZ (TU9M)
H1A - H1B - HAZ (TU1CP) - HDY (TU1M+) - HDY (TU1M) - HDZ (TU1M/ TU1M+)
K1B - K1D - K1F - K1G - K1H (TU3A) - K2A - K2B - K3A - K5A - KAY (TU3CP) - KAZ
KDX (TU3M/Z) - KDX (TU3MC) - KDY (TU3M) - KDZ (TU3M/Z) - KFT (TU3A)
KFT (TU3AE5) - KFV (TU3A) - KFV (TU3JP) - KFW (TU3A) - KFW (TU3JP)
KFX (TU3A) - KFX (TU3JP) - M4A - TU9 - TU9K - TU24 - TU32

MODELS* | MODELLI*

CITROEN

AX 10 1.0 8V - AX 11 1.1 8V - AX SPORT 1.3 8V - AX 14 1.4 8V
BERLINGO 1.1 8V - BERLINGO 1.4 8V
BX 1.1 8V - BX 1.4 8V - C15 1.0 8V - C15E 1.1 8V - C15E 1.4 8V
C2 1.4 8V - C3 1.1 1.4 8V - C3 PRURIEL 1.4 8V
SAXO 1.0 8V - SAXO 1.1 8V - SAXO 1.4 8V - XSARA 1.4 8V - ZN 1.1 8V - ZN 1.4 8V

PEUGEOT

106 I 1.0 8V - 106 I - 106 II 1.4 8V - 1007 1.4 8V
205 1.0 8V - 205 I - 205 II 1.4 8V - 206 1.4 8V - 206+ 1.4 8V
306 1.4 8V - 307 1.4 8V - 309 I - 309 II 1.4 8V - 405 II 1.4 8V
PARTNER 1.1 8V - PARTNER 1.4 8V - PARTNER 1.4 8V BIFUEL

DESCRIPTION DESCRIZIONE	P/N		CROSS REFERENCES CORRISPONDENZE			
	GA	OE	RNZ	EK	AJ	PY
CYLINDER HEAD GASKET SET, WITHOUT H.G., WITH OIL SEALS KIT GUARNIZIONI TESTATA, SENZA T.C., CON PARAOLI	043609-1099	0197.H8 + 0342.E0 (4X) + 0342.E1	02-31146-01	986.748		DT012
CYLINDER HEAD COVER GASKET GUARNIZIONE COPRITESTATA	113641-8000	0209.54 97523053	71-31146-00	776.416	11023900	JN658

*Find out our complete range: www.athena.eu | *Per ulteriori informazioni consultate il catalogo online nel nostro sito: www.athena.eu

103642-1915

CYLINDER HEAD GASKET - GUARNIZIONE TESTATA PSA GROUP



EXPERT'S NOTE - NOTA DELL'ESPERTO

Can be combined with unified head set without C.H.G. 043609-1099
Può essere abbinata al kit guarnizione testata unificato senza testa 043609-1099

ENGINES* | MOTORI*

DISPLACEMENT | CILINDRATA

1.1 8V - 1.3 8V - 1.4 8V

CODE | CODICE

H1A - H1B - HAZ (TU1CP) - HDZ (TU1M) Model year to/Anno modello dal: 09.1996 Engine code/Codice motore: TU1M

K1B - K1D - K1F - K1G - K1H (TU3A) - K2A - K2B - K3A - K5A - KAY (TU3CP) - KAZ

KDX (TU3M/Z) - KDX (TU3MC) - KDY (TU3M) - KDZ (TU3M/Z) - KFT (TU3A)

KFT (TU3AE5) - KFX (TU3A) - KFW (TU3JP) - KFW (TU3A) - KFW (TU3JP)

KFX (TU3A) - KFX (TU3JP) - M4A - TU24 - TU32

MODELS* | MODELLI*

CITROEN

AX 11 1.1 8V - AX SPORT 1.3 8V - AX 14 1.4 8V
BERLINGO 1.4 8V
BX 1.1 8V - BX 1.4 8V - C15E 1.1 8V - C15E 1.4 8V
C2 1.4 8V - C3 1.1 4I 8V - C3 PRURIEL 1.4 8V
SAXO 1.1 8V - SAXO 1.4 8V - XSARA 1.4 8V - ZN 1.1 8V - ZN 1.4 8V

PEUGEOT

106 I - 106 II 1.4 8V - 1007 1.4 8V
205 I - 205 II 1.4 8V - 206 1.4I 8V - 206+ 1.4I 8V
306 1.4 8V - 307 1.4 8V - 309 I - 309 II 1.4 8V - 405 II 1.4 8V
PARTNER 1.4 8V - PARTNER 1.4 8V BIFUEL

+0.3 mm thickness cylinder head gasket with rubber-metal insert.

Guarnizione testata con spessore maggiorato +0.3 mm con inserto gomma-metallo.



DESCRIPTION DESCRIZIONE	P/N		CROSS REFERENCES CORRISPONDENZE			
	GA	OE	RNZ	EK	AJ	PY
CYLINDER HEAD GASKET, COMPOSITE MATERIAL GUARNIZIONE TESTATA IN MATERIALE COMPOSITO	103642-1915 ^{^A}	0209.W7 0209.CK	61-33715-10		10155610	AD5711

^{^A} This head gasket is 0,3mm thicker than the standard one - Questa guarnizione testata è 0,3mm più spessa rispetto allo standard.

102332-1915

CYLINDER HEAD GASKET - GUARNIZIONE TESTATA
PSA GROUP



EXPERT'S NOTE - NOTA DELL'ESPERTO

Can be combined with unified head set without C.H.G. 043609-1099
Può essere abbinata al kit guarnizione testata unificato senza testa 043609-1099

ENGINES* | MOTORI*

DISPLACEMENT | CILINDRATA

1.1 8V - 1.3 8V - 1.4 8V

CODE | CODICE

H1A - H1B - HAZ (TU1CP) - HDZ (TU1M) Model year to/Anno motore da: 09.1996 Engine code/Codice motore: TU1M
K1B - K1D - K1F - K1G - K1H (TU3A) - K2A - K2B - K3A - K5A - KAY (TU3CP) - KAZ
KDX (TU3M/Z) - KDX (TU3MC) - KDY (TU3M) - KDZ (TU3M/Z) - KFT (TU3A)
KFT (TU3AE5) - Kfv (TU3A) - Kfv (TU3JP) - Kfw (TU3A) - Kfw (TU3JP)
KFX (TU3A) - KFX (TU3JP) - M4A - TU24 - TU32

MODELS* | MODELLI*

CITROEN

AX 11 1.1 8V - AX SPORT 1.3 8V - AX 14 1.4 8V
BERLINGO 1.4 8V
BX 1.1 8V - BX 1.4 8V - C15E 1.1 8V - C15E 1.4 8V
C2 1.4 8V - C3 I 1.41 8V - C3 PRURIEL 1.4 8V
SAXO 1.1 8V - SAXO 1.4 8V - XSARA 1.4 8V - ZN 1.1 8V - ZN 1.4 8V

PEUGEOT

106 I - 106 II 1.4 8V - 1007 1.4 8V
205 I - 205 II 1.4 8V - 206 1.41 8V - 206+ 1.41 8V
306 1.4 8V - 307 1.4 8V - 309 I - 309 II 1.4 8V - 405 II 1.4 8V
PARTNER 1.4 8V - PARTNER 1.4 8V BIFUEL

+0.3 mm thickness cylinder head gasket without rubber-metal insert.

Guarnizione testata con spessore maggiorato +0.3 mm senza inserto gomma-metallo.

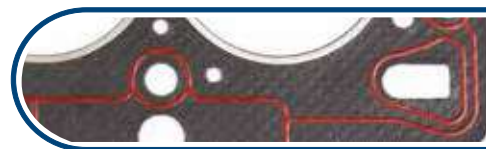

DESCRIPTION DESCRIZIONE	P/N		CROSS REFERENCES CORRISPONDENZE			
	GA	OE	RNZ	EK	AJ	PY
CYLINDER HEAD GASKET, COMPOSITE MATERIAL GUARNIZIONE TESTATA IN MATERIALE COMPOSITO	102332-1915 ^{^A}			117.831		

^{^A} This head gasket is 0,2mm thicker than the standard one - Questa guarnizione testata è 0,2mm più spessa rispetto allo standard.

053673-1051 PSA GROUP

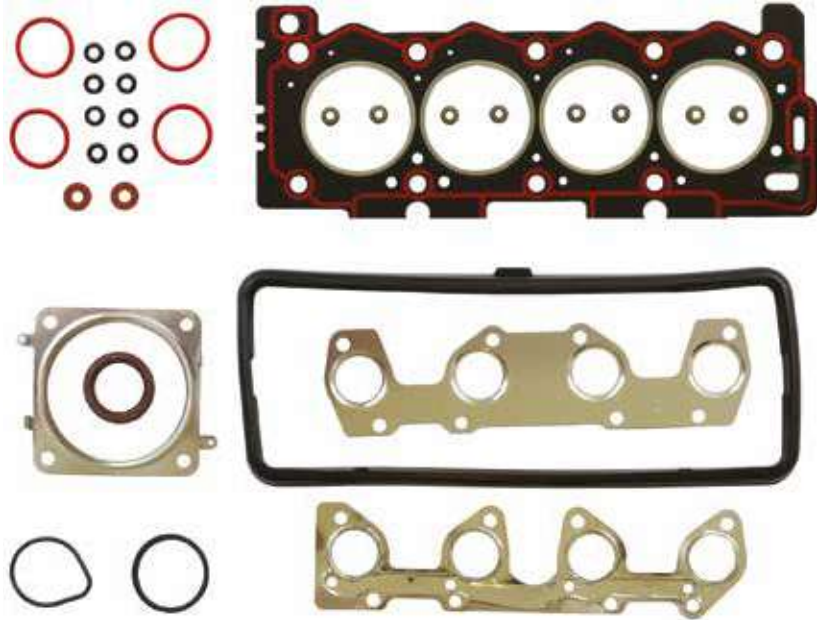

103673-1913



213673-5303



223673-5400



ENGINES* | MOTORI*

DISPLACEMENT
1.1i 8V

—
HFX - NFX (TU1JP)
HFZ (TU1JP/L3)

MODELS* | MODELLI*

CITROEN

—
BERLINGO 1.1i 8V - C2 1.1i 8V - C3 1.1i 8V - C3 II 1.1i 8V -
SAXO 1.1i 8V

PEUGEOT

—
206 1.1i 8V - PARTNER 1.1i 8V

DESCRIPTION	P/N	CROSS REFERENCES				
		OE	RNZ	EK	AJ	PY
HEAD SET WITH H.G. AND OIL SEALS	053673-1051		02-35060-01 ^A	332.230 332.640 713.070	52216400	
CYLINDER HEAD GASKET IN BI-COUPLED MATERIAL, WITHOUT ASBESTOS, WITH SCREEN PRINT	103673-1913	0209.Y0	61-35060-00	074.391	1015500	AC5701
EXHAUST MANIFOLD GASKET	213673-5303 ^B	0349.J3-K1	71-35068-00	258.311	13190500	
EXHAUST MANIFOLD GASKET	223673-5400 ^C	0349.J6	71-33774.00	515.450	13190600	

^A Without 71-33774-00/manifold gasket

^B STD L4 - Eng. HFX- Euro 3

^C STD FL5 - Eng. HFZ-Euro 4

053698-1019
PSA GROUP



ENGINES* | MOTORI*

DISPLACEMENT
1.4l 8V

TU3A (KFV) - TU3A (KFW) - TU3AE5 (KF01)

MODELS* | MODELLI*

CITROEN

C3 I - II - C3 (A51) 1.4l 8V - NEMO SW
 COMM. 1.4l 8V

PEUGEOT

206 - 206+ (T3E) 1.4l 8V - 207 - 1007 1.4l 8V BIPPER TEPEE - BERLINGO (M59) 1.4l 8V

DESCRIPTION	P/N	CROSS REFERENCES				
		OE	RNZ	EK	AJ	PY
HEAD SET WITH H.G. 103642-1912 AND OIL SEALS	053698-1019			374.650	52258000	

*Find out our complete range: www.athena.eu | *Per ulteriori informazioni consultate il catalogo online nel nostro sito: www.athena.eu

033699-1019
PSA GROUP



053699-1019

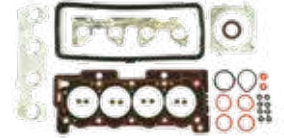

ENGINES* | MOTORI*

DISPLACEMENT
1.4i 8V

TU3JP (K F V - K F W - K F X)

MODELS* | MODELLI*

CITROEN

BERLINGO 1.4i (FROM 2003)
C2 - C3 I - C3 PLURIEL 1.4i 8V

PEUGEOT

106 II (FROM 2001) - 206 (FROM 2007) 1.4i 8V
307 (FROM 2002) - 1007 1.4i 8V

DESCRIPTION	P/N	CROSS REFERENCES				
		OE	RNZ	EK	AJ	PY
FULL SET WITH H.G. 103642-1912 AND OIL SEALS	033699-1019					
HEAD SET WITH H.G. 103642-1912 AND OIL SEALS	053699-1019			374.650 / 505.250	52216500	

053686-1000

CYLINDER HEAD GASKET SET - KIT GUARNIZIONI TESTATA PSA GROUP



103686-3814



113686-8500



113687-8500



ENGINES* | MOTORI*

DISPLACEMENT | CILINDRATA

1.4 16V

CODE | CODICE

KFU - ET3J4

MODELS* | MODELLI*

CITROEN

C2 (JM) 1.4 16V - C3I (FC-FN) 1.4 16V
C4 COUPE' (LA) 1.4 16V - C4I (LC) 1.4 16V

PEUGEOT

1007 (KM) 1.4 16V - 206 (2A-C) 1.4 16V - 206 (2E-K9) 1.4 16V
207 / 207+ (WA-WC) 1.4 16V - 307 (3A-C-E-H) 1.4 16V

DESCRIPTION DESCRIZIONE	P/N	CROSS REFERENCES CORRISPONDENZE					
		GA	OE	RNZ	EK	AJ	PY
CYLINDER HEAD GASKET SET, WITH H.G., WITH OIL SEALS KIT GUARNIZIONI TESTATA, CON T.C., CON PARAOLI	053686-1000			02-36505-01	505.300	52236600	CG9030
CYLINDER HEAD GASKET, COMPOSITE MATERIAL GUARNIZIONE TESTATA IN MATERIALE COMPOSITO	103686-3814		0209.FL 0209.CH	61-36505-00	431.381	10167100	AG9030
CYLINDER HEAD COVER GASKET, RIGHT GUARNIZIONE COPRITESTATA, DESTRA	113686-8500		0249.C5	71-36953-00	431.450	11105000	JM7051
CYLINDER HEAD COVER GASKET, LEFT GUARNIZIONE COPRITESTATA, SINISTRA	113687-8500		0249.C4 0249.EZ	71-36954-00	431.460	11105100	JM7052

*Find out our complete range: www.athena.eu | *Per ulteriori informazioni consultate il catalogo online nel nostro sito: www.athena.eu

052333-1052 **NEW**

CYLINDER HEAD GASKET SET - KIT GUARNIZIONI TESTATA PSA GROUP

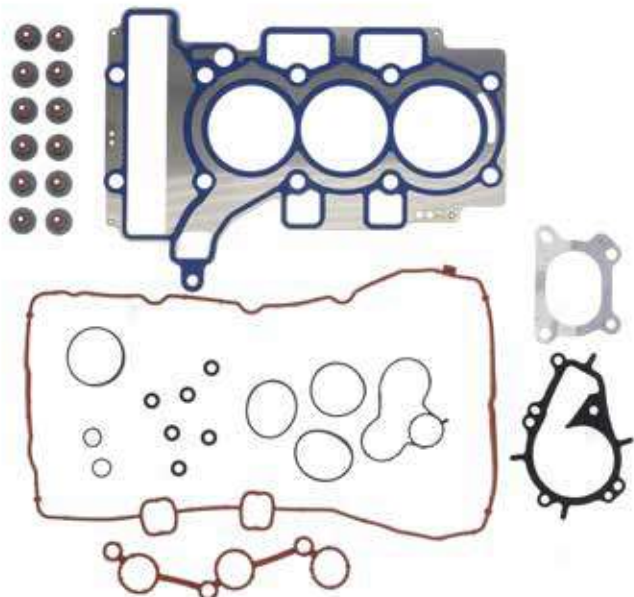

082333-9970



102333-5250



112333-0000

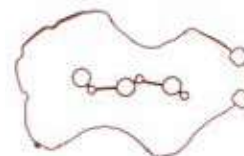

ENGINES* | MOTORI*

DISPLACEMENT | CILINDRATA

1.2 12V

CODE | CODICE

HMP (EB2FB) - HMT (EB2D) - HMU (EB2D) - HMY (EB2M) - HMZ (EB2 / EB2F)
B12XE (EB2F) - B12XEL (EB2FAD)
1PP

MODELS* | MODELLI*

CITROEN

C-ELYSEE - C1 II - C3 II - C3 III - C3 AIRCROSS - C4 CACTUS - DS3 1.2 VTI 12V

OPEL

CROSSLAND - CROSSLAND X LGP 1.2 12V

PEUGEOT

108 - 208 I - 308 II - 2008 I 1.2 VTI 12V - 208 I LGP 1.2 12V

TOYOTA

TOYOTA AYGO (_B4_) 1.2 (PAB40)

DESCRIPTION DESCRIZIONE	P/N	CROSS REFERENCES CORRISPONDENZE					
		GA	OE	RNZ	EK	AJ	PY
CYLINDER HEAD GASKET SET, WITH H.G. KIT GUARNIZIONI TESTATA, CON T.C.	052333-1052			02-37745-01	642540 ^B	52453500 ^B	
CRANKCASE GASKET SET, WITH OIL SEALS KIT GUARNIZIONI MONOBLOCCO, CON PARAOLI	082333-9970			08-10461-01	779.190	54237200 ^A	
CYLINDER HEAD GASKET, MLS GUARNIZIONE TESTATA, MLS	102333-5250	9676148680 3639558		61-37745-00	592.550	10209100	
CYLINDER HEAD COVER GASKET SET KIT GUARNIZIONI COPRITESTATA	112333-0000	9677855380 3645971		15-11549-01	634.660	56053700	

^A Set without crankshaft oil seal - Kit senza paraolio albero motore flangiato

^B Set without water pump gasket - Kit senza guarnizione pompa acqua

053693-1000
PSA GROUP

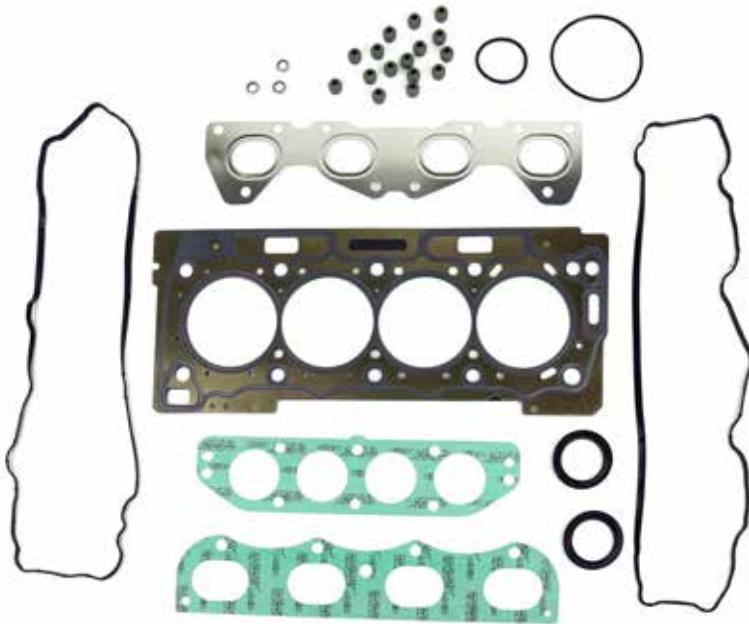

ENGINES* | MOTORI*

DISPLACEMENT
1.6l 16V

—
 TU5JP4S (NFS) Until/Fino a N.2336722

MODELS* | MODELLI*

CITROEN
 —
 C2 1.6 VTS

DESCRIPTION	P/N	CROSS REFERENCES				
		OE	RNZ	EK	AJ	PY
HEAD SET WITH MLS H.G AND OIL SEALS	053693-1000		02-35055-02			

*Find out our complete range: www.athena.eu | *Per ulteriori informazioni consultate il catalogo online nel nostro sito: www.athena.eu

053695-1000

MINI - PSA GROUP



103695-3850



113695-0000

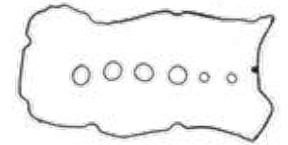

ENGINES* | MOTORI*

DISPLACEMENT

1.6 16V

1.4 16V

—

5FS-W - 8FS - EP3-C - EP6-C

N12 B14 A - N12 B16 A (MINI)

MODELS* | MODELLI*

CITROEN

—

BERLINGO II VTI 120 1.6 16V - C3 II - PICASSO VTI 95 1.4 16V - C3 II - PICASSO VTI 120 1.6 16V - C4 I-II - PICASSO I-II VTI 120 - LPG 1.6 16V - C4 GRAN PICASSO I-II VTI 120 1.6 16V - C5 III - DS3 - DS4 - VTI 120 1.6 16V

MINI

—

MINI ONE - MINI COOPER (R56) 1.4 16V - MINI CABRIOLET COOPER (R57) 1.6 16V - MINI CLUBMAN COOPER (R55) 1.6 16V

PEUGEOT

—

207 - 208 - 308 1.4 16V - 207 - 208 - 308 - 508 1.6 16V - 2008-3008 - 5008 1.6 16V - RANCH 1.6 16V

DESCRIPTION	P/N	CROSS REFERENCES				
		OE	RNZ	EK	AJ	PY
HEAD SET WITH MLS H.G (ORIGINAL PROD.)	053695-1000	11120427689 + 11127595139 (MINI)	02-38005-01+ 71-41213-00	898.110+ 729.050	52273000	CH6440
MLS HEAD GASKET (ORIGINAL PROD.)	103695-3850	11127595139 (MINI) 0209.EW (PSA)	61-38005-00	729.050	10186900	AH6440
CYLINDER HEAD COVER SET 7 PIECES	113695-0000	11127567877 (MINI) 0249.F4 (PSA)	15-37633-01	898.100	56044000	

*Find out our complete range: www.athena.eu | *Per ulteriori informazioni consultate il catalogo online nel nostro sito: www.athena.eu

053695-1052 MINI - PSA GROUP



103695-5250



113695-0000

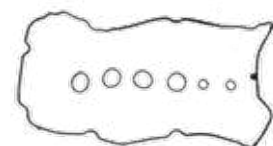

ENGINES* | MOTORI*

DISPLACEMENT

1.6 16V

1.4 16V

—

5FS-W - 8FS - EP3-C - EP6-C
N12 B14 A - N12 B16 A (MINI)

MODELS* | MODELLI*

CITROEN

—
BERLINGO II VTI 120 1.6 16V - C3 II - PICASSO VTI 95 1.4 16V - C3 II - PICASSO VTI 120 1.6 16V - C4 I-II - PICASSO I-II VTI 120 - LPG 1.6 16V - C4 GRAN PICASSO I-II VTI 120 1.6 16V - C5 III - DS3 - DS4 VTI 120 1.6 16V

MINI

—
MINI ONE - MINI COOPER (R56) 1.4 16V - MINI CABRIOLET COOPER (R57) 1.6 16V - MINI CLUBMAN COOPER (R55) 1.6 16V

PEUGEOT

—
207 - 208 - 308 1.4 16V - 207 - 208 - 308 - 508 1.6 16V - 2008- 3008 - 5008 1.6 16V - RANCH 1.6 16V

DESCRIPTION	P/N	CROSS REFERENCES				
		OE	RNZ	EK	AJ	PY
HEAD SET WITH MLS H.G (OUR PRODUCTION)	053695-1052 ^A	11120427689 + 11127595139 (MINI)	02-38005-01+ 71-41213-00	898.110+ 729.050	52273000	CH6440
MLS HEAD GASKET	103695-5250	11127595139 (MINI) 0209.EW (PSA)	61-38005-00	729.050	10186900	AH6440
CYLINDER HEAD COVER SET 7 PIECES	113695-0000	11127567877 (MINI) 0249.F4 (PSA)	15-37633-01	898.100	56044000	

^A Interchangeable with p/n 053695-1000.

*Find out our complete range: www.athena.eu | *Per ulteriori informazioni consultate il catalogo online nel nostro sito: www.athena.eu

053695-5251

MINI - PSA GROUP



103695-5251



113695-0000

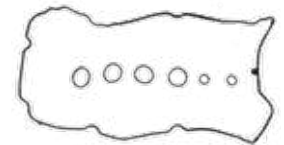

ENGINES* | MOTORI*

DISPLACEMENT

1.6 16V

1.4 16V

—

5FS-W - 8FS - EP3-C - EP6-C

N12 B14 A - N12 B16 A (MINI)

MODELS* | MODELLI*

CITROEN

—

BERLINGO II VTI 120 1.6 16V - C3 II - PICASSO VTI 95 1.4 16V - C3 II - PICASSO VTI 120 1.6 16V - C4 I-II - PICASSO I-II VTI 120 - LPG 1.6 16V - C4 GRAN PICASSO I-II VTI 120 1.6 16V - C5 III - DS3 - DS4 - VTI 120 1.6 16V

MINI

—

MINI ONE - MINI COOPER (R56) 1.4 16V - MINI CABRIOLET COOPER (R57) 1.6 16V - MINI CLUBMAN COOPER (R55) 1.6 16V

PEUGEOT

—

207 - 208 - 308 1.4 16V - 207 - 208 - 308 - 508 1.6 16V
2008- 3008 - 5008 1.6 16V - RANCH 1.6 16V

DESCRIPTION	P/N	CROSS REFERENCES				
		OE	RNZ	EK	AJ	PY
HEAD SET WITH MLS H.G OVERSIZED + 0,30 MM	053695-5251	11120427689+ 11127570860 (MINI)	02-38005-02 + 61-38005-10 + 71-41213-00			
MLS HEAD GASKET OVERSIZED + 0,30 MM	103695-5251	11127570860 (MINI)	61-38005-10			
CYLINDER HEAD COVER SET 7 PIECES	113695-0000	11127567877 (MINI) 0249.F4 (PSA)	15-37633-01	898.100	56044000	

053694-1000 MINI - PSA GROUP

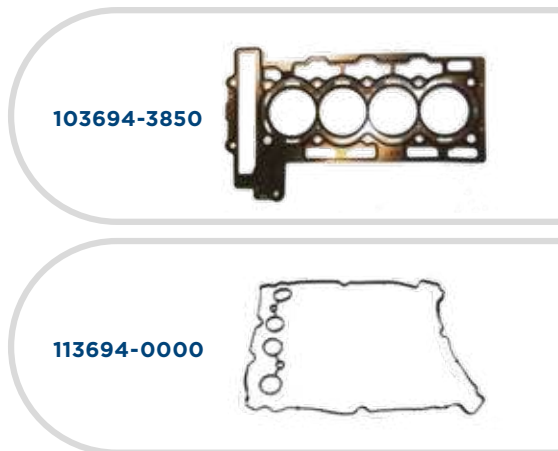
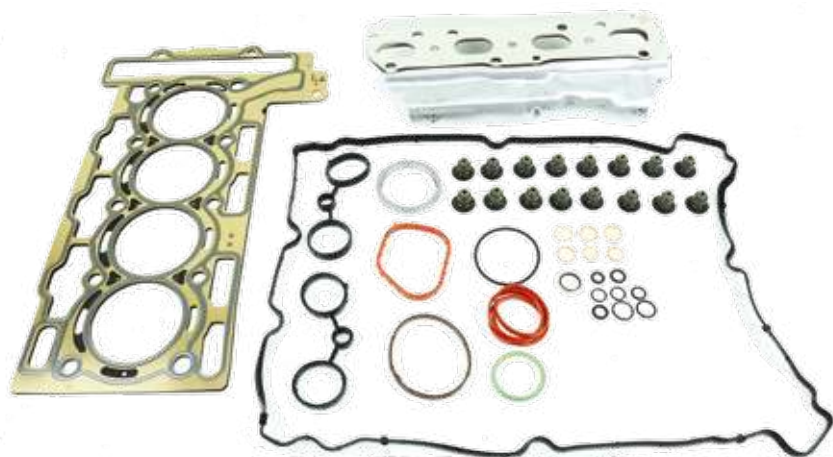

ENGINES* | MOTORI*

DISPLACEMENT
1.6 16V

5FD-N-R-S-T-X-V-Y
EP6DT-CDT-CDTX-SDTS
N14 B16 A-C (MINI)

MODELS* | MODELLI*

CITROEN

C4 I-II - PICASSO I-II THP 150 1.6 16V - C4 GRAN PICASSO I-II - THP 155 1.6 16V - C5 III - DS3 - DS4 - DS5 THP 155 1.6 16V

MINI

MINI CABRIOLET J.C.W. 1.6 16V - MINI CLUBMAN J.C.W. 1.6 16V - MINI COOPER S - COUPE J.C.W. 1.6 16V

PEUGEOT

207 - 207T - 208 1.6 16V - 308 GTI - THP - 508 THP 1.6 16V - 3008 THP - 5008 1.6 16V

DESCRIPTION	P/N	CROSS REFERENCES				
		OE	RNZ	EK	AJ	PY
HEAD SET WITH MLS H.G (ORIGINAL PROD.)	053694-1000	11120427690 + 11127595138 (MINI)	02-38010-01+ 71-41214-00	376.320	52273200	CH6730
MLS HEAD GASKET (ORIGINAL PROD.)	103694-3850	11127595138 (MINI) 0209.ER	61-38010-00	729.040	10187100	AH6730
CYLINDER HEAD COVER SET 3 PIECES	113694-0000	11127572851 (MINI) 0249.E6-7 (PSA)	15-37614-01	384.680	56044100	HM5371

*Find out our complete range: www.athena.eu | *Per ulteriori informazioni consultate il catalogo online nel nostro sito: www.athena.eu

053694-1052

MINI - PSA GROUP



103694-5250



113694-0000

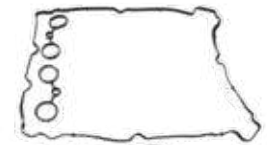

ENGINES* | MOTORI*

DISPLACEMENT
1.6 16V

5FD-N-R-S-T-X-V-Y
EP6DT-CDT-CDTX-SDTS
N14 B16 A-C (MINI)

MODELS* | MODELLI*

CITROEN

C4 I-II - PICASSO I-II THP 150 1.6 16V - C4 GRAN PICASSO I-II - THP 155 1.6 16V -
C5 III - DS3 - DS4 - DS5 THP 155 1.6 16V

MINI

MINI CABRIOLET J.C.W. 1.6 16V - MINI CLUBMAN J.C.W. 1.6 16V - MINI COOPER
S - COUPE J.C.W. 1.6 16V

PEUGEOT

207 - 207T - 208 1.6 16V - 308 GTI - THP - 508 THP 1.6 16V - 3008 THP - 5008
1.6 16V

DESCRIPTION	P/N	CROSS REFERENCES				
		OE	RNZ	EK	AJ	PY
HEAD SET WITH MLS H.G (OUR PRODUCTION)	053694-1052 ^A	11120427690 + 11127595138 (MINI)	02-38010-01+ 71-41214-00	376.320	52273200	CH6730
MLS HEAD GASKET	103694-5250	11127595138 (MINI) 0209.ER	61-38010-00	729.040	10187100	AH6730
CYLINDER HEAD COVER SET 3 PIECES	113694-0000	11127572851 (MINI) 0249.E6-7 (PSA)	15-37614-01	384.680	56044100	HM5371

^A Interchangeable with p/n 053694-1000.

053694-5251 MINI - PSA GROUP

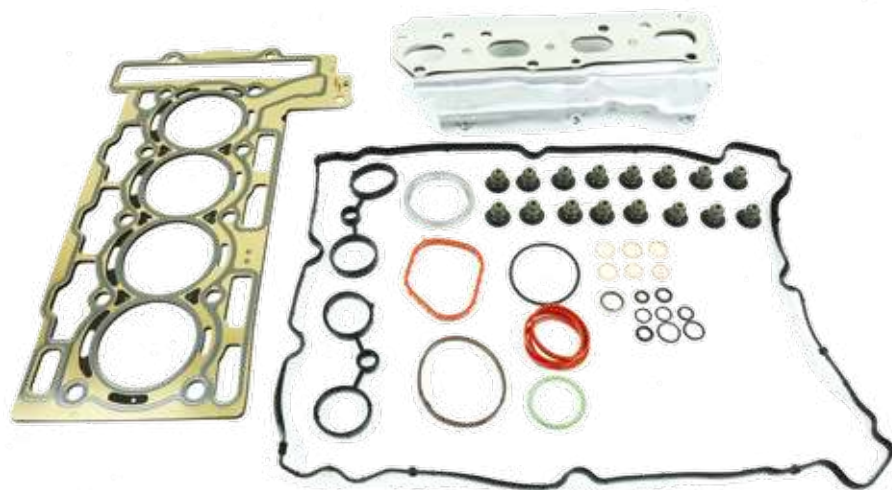

103694-5251



113694-0000



ENGINES* | MOTORI*

DISPLACEMENT
1.6 16V

5FD-N-R-S-T-X-V-Y
EP6DT-CDT-CDTX-SDTS
N14 B16 A-C (MINI)

MODELS* | MODELLI*

CITROEN

C4 I-II - PICASSO I-II THP 150 1.6 16V - C4 GRAN PICASSO I-II - THP 155 1.6 16V -
C5 III - DS3 - DS4 - DS5 THP 155 1.6 16V

MINI

MINI CABRIOLET J.C.W. 1.6 16V - MINI CLUBMAN J.C.W. 1.6 16V - MINI COOPER
S - COUPE J.C.W. 1.6 16V

PEUGEOT

207 - 207T - 208 1.6 16V - 308 GTI - THP - 508 THP 1.6 16V - 3008 THP - 5008
1.6 16V

DESCRIPTION	P/N	CROSS REFERENCES				
		OE	RNZ	EK	AJ	PY
HEAD SET WITH MLS H.G OVERSIZED + 0,30 MM	053694-5251	11120427690 + 11127586908	02-38010-02+ 61-38010-10+ 71-41214-00			
MLS HEAD GASKET OVERSIZED + 0,30 MM	103694-5251	11127586908	61-38010-10		10187110	
CYLINDER HEAD COVER SET 3 PIECES	113694-0000	11127572851 (MINI) 0249.E6-7 (PSA)	15-37614-01	384.680	56044100	HM5371

*Find out our complete range: www.athena.eu | *Per ulteriori informazioni consultate il catalogo online nel nostro sito: www.athena.eu

083674-1000

CRANKCASE GASKET SET - KIT GUARNIZIONI MONOBLOCCO PSA GROUP

163674-8000



ENGINES* | MOTORI*

DISPLACEMENT | CILINDRATA

1.6 16V

CODE | CODICE

N6A (TU5JP4) - NFR (TU5JP4B) - NFS (TU5JP4S) - NFU (TU5JP4)

MODELS* | MODELLI*

CITROEN

BERLINGO - BERLINGO FIRSTMPV 1.6 16V
C2 C3 I - C4 I - XSARA - XSARA PICASSO 1.6 16V

PEUGEOT

206 - 206 SW - 206 CC 1.6 16V
207+ - 307 - 307 SW - 307 CC 1.6 16V
308 I SW - 1007 1.6 16V
PARTNER - PARTNER TEPEE 1.6 16V

DESCRIPTION DESCRIZIONE	P/N		CROSS REFERENCES CORRISPONDENZE			
	GA	OE	RNZ	EK	AJ	PY
CRANKCASE GASKET SET KIT GUARNIZIONI MONOBLOCCO	083674-1000		08-35253-01	431.610	54131700	ED5180
OIL SUMP GASKET GUARNIZIONE COPPA OLIO	163674-8000	0304.55	71-35253-00	331.690	14091300	JH5107

*Find out our complete range: www.athena.eu | *Per ulteriori informazioni consultate il catalogo online nel nostro sito: www.athena.eu

043678-1000

PSA GROUP

FORD - MAZDA - TOYOTA

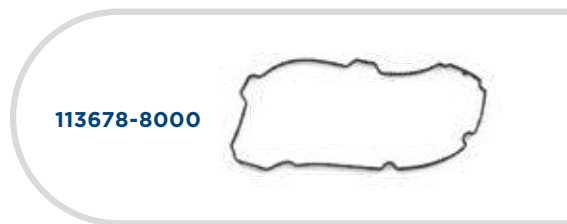
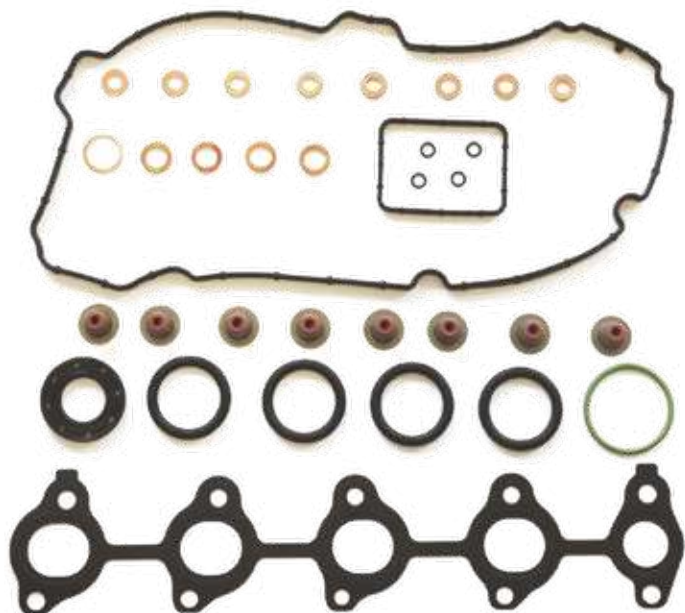

113678-8000

ENGINES* | MOTORI*

DISPLACEMENT
1.4 HDI 8V
1.4 TdCi 8V
 —
 DV4D - DV4TD
 8HX - 8HS - 8HR - 8HZ
 F6JA-B-C-D - KVJA
 2WZ-TV

MODELS* | MODELLI*

CITROEN
 —
 C1-C2-C3 1.4 HDI 8V - NEMO - XSARA 1.4 HDI 8V

FORD
 —
 FIESTA V-VI 1.4 TdCi 8V - FIGO- FUSION-IKON 1.4 TdCi 8V

MAZDA
 —
 2 1.4 HDI 8V

PEUGEOT
 1007 1.4 HDI 8V - 206 - 207 - 307 1.4 HDI 8V - BIPPER 1.4 HDI 8V

TOYOTA
 —
 AYGO 1.4 HDI 8V

DESCRIPTION	P/N	CROSS REFERENCES				
		OE	RNZ	EK	AJ	PY
HEAD SET WITHOUT H.G. WITH OIL SEALS	043678-1000		02-35542-01	030.760	53017700	
CYLINDER HEAD COVER	113678-8000	0249.C1	71-35542-00	027.730	11096400	JM5299

*Find out our complete range: www.athena.eu | *Per ulteriori informazioni consultate il catalogo online nel nostro sito: www.athena.eu

083678-1051

**FIAT GROUP - FORD - MAZDA -
PSA - SUZUKI - TOYOTA - VOLVO**

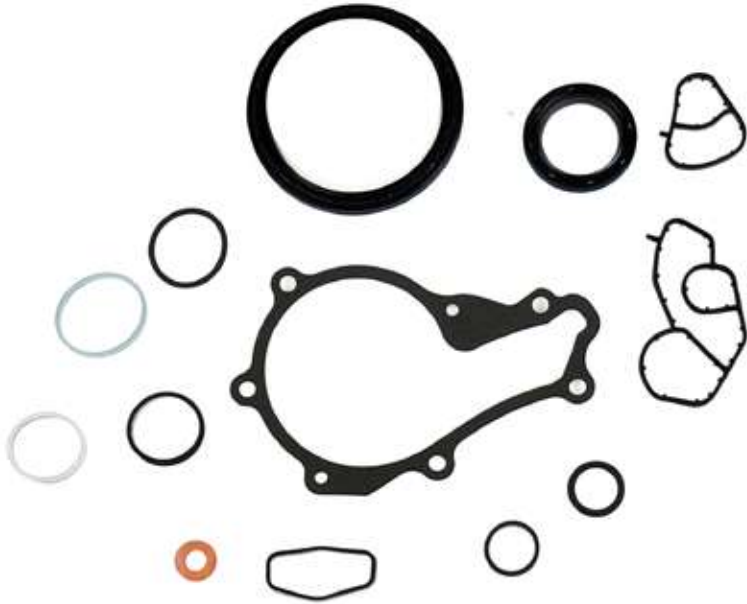

ENGINES* | MOTORI*

DISPLACEMENT
1.4 TD 8V - 1.6 TD 16V

8HS - T - X - Y - Z (DV4TD - TED4 - ATED4) - 9HS - T - U - W - X - Y - Z (DV6TED4BU - ATED4)
F6JA - B - C - D - G8DA - B - C - D - HHDA - B ZWZ - TV - D 416 HT - 9HU

MODELS* | MODELLI*

FIAT

—
SCUDO 1.6 D MULTIJET 16V

FORD

—
FIESTA V-VI - FUSION 1.4 - 1.6 TDCI ETC.

MAZDA

—
MAZDA 2 1.4 HDI 8V - MAZDA 3 1.6 DI TB 16V

CITROEN

—
C1 - C2 - C3 1.4 HDI 8V - NEMO 1.4 HDI 8V
BERLINGO 1.6 HDI 16V - JUMPY 1.6 HDI 16V ETC.

PEUGEOT

—
206 - 207 - 307 - 1007 1.4 HDI 8V - 1.6 HDI 16V ETC.

SUZUKI

—
LIANA 1.4 DDIS 8V - SANTANA 1.6 HDI 16V

TOYOTA

—
AYGO 1.4 HDI 8V

VOLVO

—
C30 - S40 - S80 - V50 - V70 1.6 D 16V

DESCRIPTION	P/N	CROSS REFERENCES				
		OE	RNZ	EK	AJ	PY
CRANKCASE GASKET SET	083678-1051 ^A		08-36869-01	030.780	54131500	ED5130

^A Cancels and supercedes p/n 083678-1000

103678-5251

PSA GROUP - FORD - MAZDA TOYOTA



ENGINES* | MOTORI*

DISPLACEMENT

1.4 HDI 8V

1.4 TDCI 8V

—

DV4D - DV4TD
8HX - 8HS - 8HR - 8HZ
F6JA-B-C-D - KVJA
2WZ-TV

MODELS* | MODELLI*

CITROEN

C1-C2-C3 1.4 HDI 8V - NEMO - XSARA 1.4 HDI 8V

FORD

FIESTA V-VI 1.4 TDCI 8V - FIGO - FUSION-IKON 1.4 TDCI 8V

MAZDA

2 1.4 HDI 8V

PEUGEOT

1007 1.4 HDI 8V - 206 - 207 - 307 1.4 HDI 8V - BIPPER 1.4 HDI 8V

TOYOTA

AYGO 1.4 HDI 8V

DESCRIPTION	P/N	CROSS REFERENCES				
		OE	RNZ	EK	AJ	PY
MLS HEAD GASKET THICKNESS 1,25 MM 2 NOTCHES	103678-5251 ^A	0209.AC	61-35430-00	100.400		
MLS HEAD GASKET THICKNESS 1,30 MM 3 NOTCHES	103678-5252 ^B	0209.AE	61-35430-10	100.410		
MLS HEAD GASKET THICKNESS 1,35 MM 1 NOTCH	103678-5253 ^C	0209.AF	61-35430-20	100.420		
MLS HEAD GASKET THICKNESS 1,40 MM 4 NOTCHES	103678-5254 ^D	0209.AG	61-35430-30	100.430		
MLS HEAD GASKET THICKNESS 1,45 MM 5 NOTCHES	103678-5255 ^E	0209.AH	61-35430-40	100.440		

^A Cancels and supercedes p/n 103678-3851

^B Cancels and supercedes p/n 103678-3852

^C Cancels and supercedes p/n 103678-3853

^D Cancels and supercedes p/n 103678-3854

^E Cancels and supercedes p/n 103678-3855

043688-1000

**PSA GROUP - FIAT - FORD -
MAZDA - MINI
SUZUKI - VOLVO**



113688-8000



ENGINES* | MOTORI*

DISPLACEMENT
1.6 HDI 16V
1.6 D MULTIJET
1.6 TDCI 16V
1.6 16V
1.6 D 16V

—
DV6TED4-DV6ATED4 Etc.
9HX-9HZ-9H Etc.
G8DA-Y601-D4164T

MODELS* | MODELLI*

CITROEN

—
BERLINGO 1.6 HDI 16V - C2-C3-C4-C5 1.6 HDI 16V - XSARA PICASSO 1.6 HDI 16V

FIAT

—
SCUDO 1.6 D MULTIJET

FORD

—
FIESTA V-VI 1.6 TdCi 16V - FOCUS - C MAX 1.6 TdCi 16V

MAZDA

—
3-5 1.6 HDI 16V

MINI

—
CLUBMAN-COOPER-ONE D 1.6 16V

PEUGEOT

—
206 -207-307-308-407-1007-3008-5008-PARTNER - EXPERT 1.6 HDI 16V

SUZUKI

—
SANTANA-SX4 1.6 HDI 16V

VOLVO

—
C30-S40-S80-V50-V70 III 1.6 D 16V

DESCRIPTION	P/N	CROSS REFERENCES				
		OE	RNZ	EK	AJ	PY
HEAD SET WITHOUT H.G. WITH OIL SEALS	043688-1000		02-36567-01	569.410	53018300	
CYLINDER HEAD COVER	113688-8000	0249-C2	71-36567-00	375.510	11097900	JM7123

*Find out our complete range: www.athena.eu | *Per ulteriori informazioni consultate il catalogo online nel nostro sito: www.athena.eu

103688-5251

PSA GROUP - FIAT - FORD - MAZDA - MINI - SUZUKI - VOLVO



ENGINES* | MOTORI*

DISPLACEMENT

1.6 HDI 16V

1.6 TDCI 16V

—

DV6TED4-DV6ATED4 Etc.

9HX-9HZ-9HY Etc.

G8DA-Y601-D4164T

MODELS* | MODELLI*

CITROEN

—

BERLINGO 1.6 HDI 16V - C2-C3-C4-C5 1.6 HDI 16V
XSARA PICASSO 1.6 HDI 16V
FIAT

—

SCUDO 1.6 D MULTIJET

FORD

—

FIESTA V-VI 1.6 TDCI 16V - FOCUS - C MAX 1.6 TDCI 16V

MAZDA

—

3-5 1.6 HDI 16V

MINI

—

CLUBMAN-COOPER-ONE D 1.6 16V

PEUGEOT

—

206-207-307-308-407-1007-3008-5008-PARTNER-EXPERT 1.6 HDI 16V

SUZUKI

—

SANTANA-SX4 1.6 HDI 16V

VOLVO

—

C30-S40-S80-V50-V70 III 1.6 D 16V

DESCRIPTION	P/N	CROSS REFERENCES				
		OE	RNZ	EK	AJ	PY
MLS HEAD GASKET THICKNESS 1,35 MM 1 HOLES	103688-5251	0209.CE	61-36265-20	569.802		
MLS HEAD GASKET THICKNESS 1,25 MM 2 HOLES	103688-5252	0209.CA	61-36265-00	569.812		
MLS HEAD GASKET THICKNESS 1,30 MM 3 HOLES	103688-5253	0209.CC	61-36265-10	569.822		
MLS HEAD GASKET THICKNESS 1,40 MM 4 HOLES	103688-5254	0209.CF	61-36265-30	569.832		
MLS HEAD GASKET THICKNESS 1,45 MM 5 HOLES	103688-5255	0209.CG	61-36265-40	569.842		

*Find out our complete range: www.athena.eu | *Per ulteriori informazioni consultate il catalogo online nel nostro sito: www.athena.eu

041526-1099

**PSA GROUP - FORD
MAZDA - VOLVO**



111526-8500



ENGINES* | MOTORI*

DISPLACEMENT
1.5 - 1.6 HDI 8V

9HR - DV6C (PSA)
AEDA - NGCA-DA-DB - T1BA-B-C-DA-B - T3CA-B - XVJA-B-C-D etc. (FORD)
Y650 - 655 - 661 (MAZDA) - D4162 T (VOLVO)

MODELS* | MODELLI*

CITROEN

BERLINGO - C3 II - C4 II - C5 III - DS3 - DS4 - DS5 1.6 HDI 8V

FORD

B-MAX - C-MAX II - FIESTA VI - FOCUS III - MONDEO IV-V - TRANSIT 1.5-1.6 TdCi 8V

MAZDA

MAZDA 2 - 3 - 5 1.6 CD 8V

PEUGEOT

207 - 208 - 308 - 508 - 3008 - 5008 1.6 Hdi 8V

VOLVO

C30 - S40 II - S60 II - S80 II - V40 - V50 - V60 - V70 II 1.6 DRIVe D2 8V

DESCRIPTION	P/N	CROSS REFERENCES				
		OE	RNZ	EK	AJ	PY
HEAD SET WITHOUT H.G. WITH OIL SEALS	041526-1099		02-40903-01	570.920	53052000	CH7260
CYLINDER HEAD COVER	111526-8500	0249-G2 / 1704086	71-40903-00	453.420	11121600	JM7141

*Find out our complete range: www.athena.eu | *Per ulteriori informazioni consultate il catalogo online nel nostro sito: www.athena.eu

041533-1099

**PSA GROUP - FIAT MAZDA
MITSUBISHI - TOYOTA**



ENGINES* | MOTORI*

DISPLACEMENT
1.4 - 1.6 HDI 8V

8HP - 8HR - 9HC-D-E-F-H-J-K-L-M-N
DV4C - DV6C - DV6CTED - DV6DTED - DV6TEDM - DV6ETED - DV6ETEDM
9H07 - 9HM - DV6UC (FIAT) - Y650 - 655 - 661 (MAZDA) - D4162 T (VOLVO)

MODELS* | MODELLI*

CITROEN

C3 II - DS3 1.4 HDI 8V - C3 II-C4 II - C5 III - DS3 - DS4 - DS5 1.6 HDI 8V
BERLINGO - C3 - C4 PICASSO - AIRCROSS - CACTUS - JUMPY 1.6 HDI 8V

FIAT

SCUDO 1.6 D MULTIJET 8V

MAZDA

2 - 3 - 5 1.6 CD 8V

MITSUBISHI

ASX 1.6 DI-D 8V

PEUGEOT

206+ - 207 - 1.4 HDI 8V - 207 - 208 - 308 - 508 - 2008 - 3008 - 5008 1.6 HDI 8V
EXPERT RANCH - PARTNER 1.6 HDI 8V

TOYOTA

PROACE 1.6 D 8V

DESCRIPTION	P/N	CROSS REFERENCES				
		OE	RNZ	EK	AJ	PY
HEAD SET WITHOUT H.G. WITH OIL SEALS	041533-1099		02-40903-02	570.910	53051900	
CYLINDER HEAD COVER	111526-8500	0249.G2 / 1704086	71-40903-00	453.420	11121600	JM7141

*Find out our complete range: www.athena.eu | *Per ulteriori informazioni consultate il catalogo online nel nostro sito: www.athena.eu

101535-5251

**FORD - MAZDA - PSA GROUP
VOLVO**



ENGINES* | MOTORI*

**DISPLACEMENT
1.6 HDi - TDCi 8V**

9HD-HL-HR - DV6C-DV6ETEMD (PSA)
NGCA-DA-DB - T1BA-B-C-DA-B - T3CA-B - TZGA - U3CA - UBGA etc. (FORD)
Y650 - 655 - 661 (MAZDA) - D4162 T (VOLVO)

MODELS* | MODELLI*

CITROEN

BERLINGO 110 (FINO 12999) - C3 II - C4 II - C5 III - DS3 - DS4 - DS5 1.6 HDi 8V

FORD

B-MAX - C-MAX II - FIESTA VI - FOCUS III - MONDEO IV-V - TRANSIT 1.5-1.6 TDCi 8V

MAZDA

2 - 3 - 5 1.6 CD 8V

PEUGEOT

207 - 208 - 308 - 508 - 2008 - 3008 - 5008 - PARTNER 1.6 HDi 8V

VOLVO

C30 - S40 II - S60 II - S80 II - V40 - V50 - V60 - V70 II 1.6 DRiVe D2 8V

DESCRIPTION	P/N	CROSS REFERENCES				
		OE	RNZ	EK	AJ	PY
MLS HEAD GASKET TH. 1,25 MM 2+3 NOTCHES	101535-5251	0209.JF / 1698964	61-37940-00			
MLS HEAD GASKET TH. 1,3 MM 3+3 NOTCHES	101535-5252	0209.JG / 1698965	61-37940-10			
MLS HEAD GASKET TH. 1,35 MM 1+3 NOTCHES	101535-5253	0209.JH / 1698966	61-37940-20			
MLS HEAD GASKET TH. 1,4 MM 4+3 NOTCHES	101535-5254	0209.JJ / 1698967	61-37940-30			
MLS HEAD GASKET TH. 1,45 MM 5+3 NOTCHES	101535-5255	0209.JK / 1698968	61-37940-40			

101536-5251

**FIAT GROUP - OPEL
PSA GROUP - TOYOTA**



ENGINES* | MOTORI*

**DISPLACEMENT
1.6 HDi - TDCi 8V**

9HC-HL-HJ-BHS-V-HW - DV6C-DV6DTED-M-DV6FDU etc.
(PSA)
9HM-DV6C (FIAT) - B16DT-DTH-DV6FC-D (OPEL) - 3WZ-HV-TV (TOYOTA)

MODELS* | MODELLI*

CITROEN

BERLINGO 110 (DAL 13000) - C3 II - C4 II - C5 III - DS3 - DS4 - DS5 1.6 HDi 8V

FIAT

SCUDO 1.6 D MULTIJET 8V

OPEL

CROSSLAND X (P17) - GRANDLAND X 1.6 TD

PEUGEOT

207 - 208 - 308 - 508 - 2008 - 3008 - 5008 - PARTNER 1.6 HDi 8V

TOYOTA

PROACE (MDX-Z) 1.6 D

DESCRIPTION	P/N	CROSS REFERENCES				
		OE	RNZ	EK	AJ	PY
MLS HEAD GASKET TH. 1,25 MM 3 NOTCHES	101536-5251	0209.JN / 3646404	61-10039-00			
MLS HEAD GASKET TH. 1,3 MM 4 NOTCHES	101536-5252	0209.JP / 3646405	61-10039-10			
MLS HEAD GASKET TH. 1,35 MM 2 NOTCHES	101536-5253	0209.JQ / 3645892	61-10039-20			
MLS HEAD GASKET TH. 1,4 MM 5 NOTCHES	101536-5254	0209.JR / 3646406	61-10039-30			
MLS HEAD GASKET TH. 1,45 MM 6 NOTCHES	101536-5255	0209.JS / 3646407	61-10039-40			

*Find out our complete range: www.athena.eu | *Per ulteriori informazioni consultate il catalogo online nel nostro sito: www.athena.eu

101537-5251

FORD - PSA GROUP

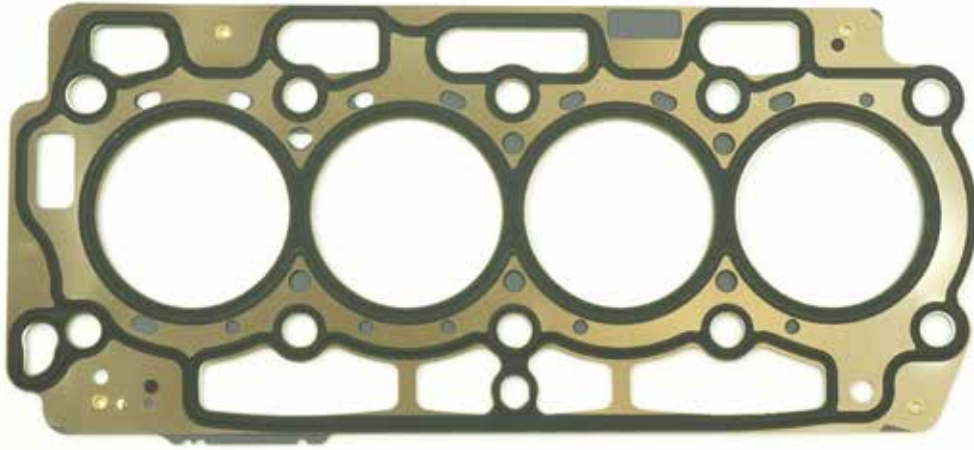

ENGINES* | MOTORI*

DISPLACEMENT
1.4 HDi - 1.5 TDCi

8HR - 8HP - DV4C
AEDA- KVJA - UGCA - XUCA - XVCA - XVJA - XXGA etc.

MODELS* | MODELLI*

CITROEN

C3 II - DS3 1.4 Hdi 8V

FORD

B-MAX - C-MAX II - GRAND C-MAX - ECOSPORT - FIESTA VI 1.5 TDCi 8V
FOCUS III - MONDEO V - TRANSIT CONNECT-COURIER 1.5 TDCi 8V
TOURNEO CONNECT-COURIER - GRAND TOURNEO CONNECT 1.5 TDCi 8V

PEUGEOT

207 - 208 - 2008 - 1.4 Hdi 8V

DESCRIPTION	P/N	CROSS REFERENCES				
		OE	RNZ	EK	AJ	PY
MLS HEAD GASKET TH. 1,25 MM 2+2 NOTCHES	101537-5251	0209.HH / 1703259	61-37945-00	490.001	10215800	
MLS HEAD GASKET TH. 1,3 MM 3+2 NOTCHES	101537-5252	0209.HJ / 1703267	61-37945-10	490.011	10215810	
MLS HEAD GASKET TH. 1,35 MM 1+2 NOTCHES	101537-5253	0209.HK / 1703268	61-37945-20	490.021	10215820	
MLS HEAD GASKET TH. 1,4 MM 4+2 NOTCHES	101537-5254	0209.HL / 1703270	61-37945-30	490.031	10215830	
MLS HEAD GASKET TH. 1,45 MM 5+2 NOTCHES	101537-5255	0209.HN / 1703275	61-37945-40	490.041	10215840	

103658-5251

PSA GROUP - FIAT - SUZUKI



ENGINES* | MOTORI*

DISPLACEMENT
1.9 TD 8V

—
D8A-B-C - DHV-W-X-Y
XUD9TE-TF-TL-TY-UTF-BTF
XUD9BSD - XUD9SD

MODELS* | MODELLI*

CITROEN

—
EVASION - XANTIA 1.9 TD 8V - XSARA - ZX 1.9 TD 8V - DISPATCH - JUMPER 1.9 TD 8V - JUMPY - RELAY 1.9 TD 8V

FIAT

—
ULYSSE - SCUDO 1.9 TD 8V

PEUGEOT

—
306 1.9 TD 8V - 405 - 406 - 806 1.9 TD 8V - BOXER 1.9 TD 8V - EXPERT 1.9 TD 8V

SUZUKI

—
BALENO - SAMURAI 1.9 TD 8V

DESCRIPTION	P/N	CROSS REFERENCES				
		OE	RNZ	EK	AJ	PY
MLS HEAD GASKET TH.1,36 MM - 1 NOTCH	103658-5251 ^A	0209.Y5	61-33155-00	147.522	10100500	BX930
MLS HEAD GASKET TH.1,40 MM - 2 NOTCHES	103658-5252 ^B	0209.Y6	61-33155-10	147.532	10100510	BX940
MLS HEAD GASKET TH.1,44 MM - 3 NOTCHES	103658-5253 ^C	0209.Y7	61-33155-20	147.542	10100520	BX950
MLS HEAD GASKET TH.1,48 MM - 4 NOTCHES	103658-5254 ^D	0209.Y8	61-33155-30	147.552	10100530	BX960
MLS HEAD GASKET TH.1,52 MM - 5 NOTCHES	103658-5255 ^E	0209.Y9	61-33155-40	147.562	10100540	BX970

^A Cancels and supercedes p/n 103658-3851

^B Cancels and supercedes p/n 103658-3852

^C Cancels and supercedes p/n 103658-3853

^D Cancels and supercedes p/n 103658-3854

^E Cancels and supercedes p/n 103658-3855

043670-1000
PSA GROUP
FIAT - TOYOTA

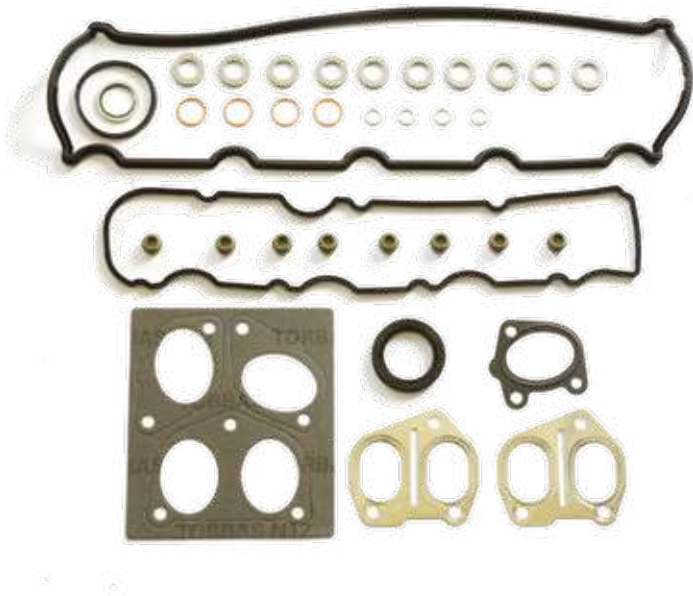

113670-8000



123670-8000



ENGINES* | MOTORI*

DISPLACEMENT
1.9 D 8V
 —
 DW8-DW8B
 WJY-WJZ-1WZ

MODELS* | MODELLI*

CITROEN
 —
 BERLINGO 1.9 D 8V - XSARA 1.9 D 8V - JUMPY 1.9 D 8V

FIAT
 —
 SCUDO 1.9 D 8V

PEUGEOT
 —
 206 1.9 D 8V - 306 1.9 D 8V - EXPERT 1.9 D 8V - PARTNER 1.9 D 8V

TOYOTA
 —
 COROLLA 1.9 D 8V

DESCRIPTION	P/N	CROSS REFERENCES				
		OE	RNZ	EK	AJ	PY
HEAD SET WITHOUT H.G. WITH OIL SEALS	043670-1000	0197.X5	02-34356-01	219.230	53009900	
CYLINDER HEAD COVER GASKET UPPER	113670-8000	0249.95	71-34356-00	773.650	11074200	JM5088
CYLINDER HEAD COVER GASKET LOWER	123670-8000	0249.97	71-34353-00	773.660	11074300	JM5089

103670-5251

PSA GROUP - FIAT - TOYOTA



ENGINES* | MOTORI*

DISPLACEMENT

1.9 D 8V

—
DW8-DW8B
WJY-WJZ-1WZ

MODELS* | MODELLI*

CITROEN

—
BERLINGO 1.9 D 8V - XSARA 1.9 D 8V - JUMPY 1.9 D 8V

FIAT

—
SCUDO 1.9 D 8V

PEUGEOT

—
206 1.9 D 8V - 306 1.9 D 8V - EXPERT 1.9 D 8V - PARTNER 1.9 D 8V

TOYOTA

—
COROLLA 1.9 D 8V

DESCRIPTION	P/N	CROSS REFERENCES				
		OE	RNZ	EK	AJ	PY
MLS HEAD GASKET THICKNESS 1,26 MM 1 HOLE	103670-5251 ^A	0209.X0	61-33720-00	130.642		
MLS HEAD GASKET THICKNESS 1,30 MM 2 HOLES	103670-5252 ^B	0209.X1	61-33720-10	130.652		
MLS HEAD GASKET THICKNESS 1,34 MM 3 HOLES	103670-5253 ^C	0209.X2	61-33720-20	130.662		
MLS HEAD GASKET THICKNESS 1,38 MM 4 HOLES	103670-5254 ^D	0209.X3	61-33720-30	130.672		
MLS HEAD GASKET THICKNESS 1,42 MM 5 HOLES	103670-5255 ^E	0209.X4	61-33720-40	130.682		

^A Cancels and supercedes p/n 103670-3851

^B Cancels and supercedes p/n 103670-3852

^C Cancels and supercedes p/n 103670-3853

^D Cancels and supercedes p/n 103670-3854

^E Cancels and supercedes p/n 103670-3855

043671-1000

**PSA GROUP
FIAT GROUP - SUZUKI**



113671-8000



ENGINES* | MOTORI*

DISPLACEMENT
2.0-2.2 HDI 8V
2.0 JTD 8V

—
DW10TD-UTD-ATED-BTED
DW12UTED4
RHY-RHV-RHZ-RHX-4HY

MODELS* | MODELLI*

CITROEN

—
BERLINGO 2.0 HDI 8V - C5 2.0 HDI 8V - EVASION 2.0 - JUMPER 2.0-2.2 HDI 8V -
SYNERGIE-XANTIA 2.0 HDI 8V - XSARA-XSARA PICASSO 2.0 HDI 8V - DISPATCH
-JUMPY 2.0 HDI 8V

FIAT GROUP

—
ULYSSE 2.0 JTD 8V - NUOVO DUCATO 2.0 JTD 8V - SCUDO 2.0 JTD 8V - LANCIA
ZETA 2.0 JTD 8V

PEUGEOT

—
206 -306-307-406-806 2.0 HDI 8V - BOXER-PARTNER 2.0 HDI 8V

SUZUKI

—
VITARA 2.0 HDI 8V

DESCRIPTION	P/N	CROSS REFERENCES				
		OE	RNZ	EK	AJ	PY
HEAD SET WITHOUT H.G. WITH OIL SEALS - UNIFIED	043671-1000	0197.X3 9569752780	02-34398-01	262.790 851.361	53013900 53010000	
CYLINDER HEAD COVER	113671-8000	0249.99	71-34398-00	851.560	11077300	

*Find out our complete range: www.athena.eu | *Per ulteriori informazioni consultate il catalogo online nel nostro sito: www.athena.eu

103671-5252

PSA GROUP - FIAT SUZUKI

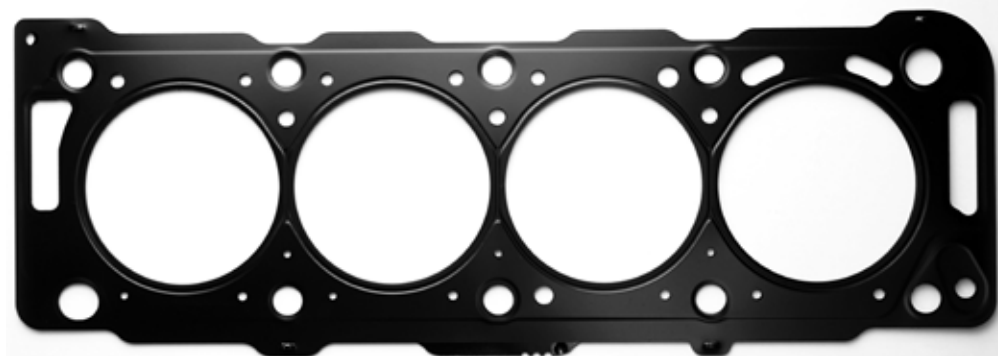

ENGINES* | MOTORI*

DISPLACEMENT

2.0 - JTD 8V

—
DW10TD-UTD-ATED-BTED
DW12UTED4
RHY-RHV-RHZ-RHX-4HY

MODELS* | MODELLI*

CITROEN

—
BERLINGO 2.0 HDI 8V - C5 2.0 HDI 8V - EVASION 2.0-JUMPER 2.0-2.2 HDI 8V -
SYNERGIE-XANTIA 2.0 HDI 8V - XSARA-XSARA PICASSO 2.0 HDI 8V - DISPATCH-
JUMPY 2.0 HDI 8V

FIAT

—
ULYSSE 2.0 JTD 8V - NUOVO DUCATO 2.0 JTD 8V - SCUDDO 2.0 JTD 8V

LANCIA

—
ZETA 2.0 JTD 8V

PEUGEOT

—
206 -306-307-406-806 2.0 HDI 8V - BOXER-PARTNER 2.0 HDI 8V

SUZUKI

—
VITARA 2.0 HDI 8V

DESCRIPTION	P/N	CROSS REFERENCES				
		OE	RNZ	EK	AJ	PY
MLS HEAD GASKET TH. 1,35 MM 2 NOTCHES	103671-5252 ^A	0209.X6	61-35815-10	075.830		
MLS HEAD GASKET TH. 1,40 MM 3 NOTCHES	103671-5253 ^B	0209.X7	61-35815-20	075.840		
MLS HEAD GASKET TH. 1,45 MM 4 NOTCHES	103671-5254 ^C	0209.X8	61-35815-30	075.850		
MLS HEAD GASKET TH. 1,50 MM 5 NOTCHES	103671-5255 ^D	0209.X9	61-35815-40	075.860		

^A Cancels and supercedes p/n 103671-3852

^B Cancels and supercedes p/n 103671-3853

^C Cancels and supercedes p/n 103671-3854

^D Cancels and supercedes p/n 103671-3855

043690-1099

**FIAT GROUP - FORD
PSA GROUP - VOLVO**



ENGINES* | MOTORI*

DISPLACEMENT
2.0 HDI - TDCI 16V

DW10BTED4 (RHF-J-R) - EW10A (RFH-RHK)AZBA-C - AZWA-C - G6DA-B-C-D-E-F-G
ETC. - D4204 T - T2

MODELS* | MODELLI*

FIAT

—
SCUDO - ULYSSE 2.0 D MULTIJET - LANCIA PHEDRA 2.0 JTD

FORD

—
C-MAX - FOCUS II - GALAXY - KUGA - MONDEO - S-MAX 2.0 TDCI

CITROEN

—
C4 - C5 III - C8 2.0 HDI

PEUGEOT

—
307 - 308 - 407 - 508 - 607 - 807 - EXPERT 2.0 HDI

VOLVO

—
C30 - C70 - S40 - S80 - V50 - V70 2.0 D

DESCRIPTION	P/N	CROSS REFERENCES				
		OE	RNZ	EK	AJ	PY
HEAD SET WITHOUT H.G. WITH OIL SEALS	043690-1099	0197.AC 0348.S3	02-36571-01	527.550	53020500	CD5500

053752-1051

CYLINDER HEAD GASKET SET - KIT GUARNIZIONI TESTATA NISSAN - RENAULT

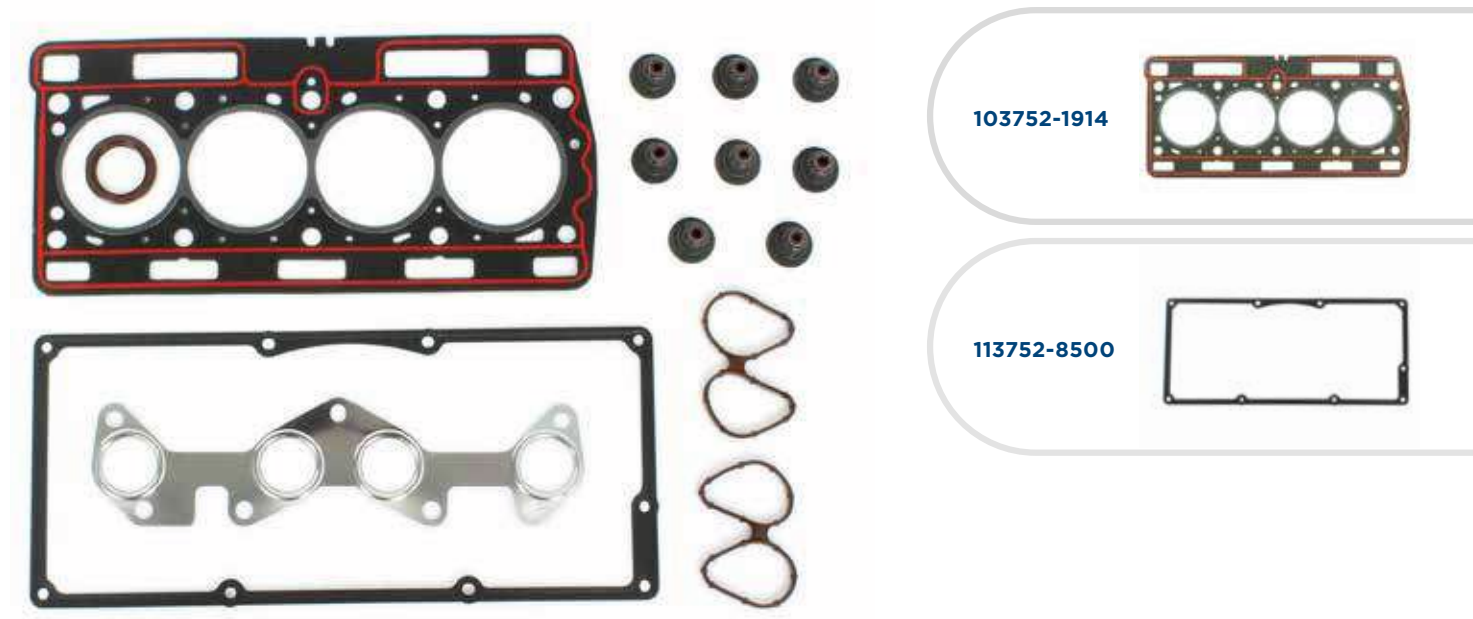

ENGINES* | MOTORI*

DISPLACEMENT | CILINDRATA

1.2 8V

CODE | CODICE

D7D 740 - D7D 760
D7F 700 - 701 - 702 - 703 - 704 - 706 - 710 - 720 - 722 - 726 - 730 - 744 - 746 -764

MODELS* | MODELLI*

NISSAN

KUBISTAR (X76) 1.2 8V

RENAULT

CLIO I (B-C 57- 5-357) 1.2 8V - CLIO II (BB-CB-SB0-1-2) 1.2 8V
KANGOO (KC0-1) - KANGOO RAPID (FC0-1) 1.2 8V
TWINGO I (C06) 1.2 8V - TWINGO II (CNO) 1.2 8V

DESCRIPTION DESCRIZIONE	P/N		CROSS REFERENCES CORRISPONDENZE			
	GA	OE	RNZ	EK	AJ	PY
CYLINDER HEAD GASKET SET, WITH H.G., WITH OIL SEALS KIT GUARNIZIONI TESTATA, CON T.C., CON PARAOLI	053752-1051	7701469326 7701472249	02-33585-01	219.240	52143200	DX630
CYLINDER HEAD GASKET, COMPOSITE MATERIAL GUARNIZIONE TESTATA IN MATERIALE COMPOSITO	103752-1914	7700864736 8200034315	61-33585-00	012.361	10105700	BX631
CYLINDER HEAD COVER GASKET, ALUMINIUM GUARNIZIONE COPRITESTATA IN ALLUMINIO	113752-8500	7701471213 7700868132 7700106172	71-31651-00	773.310	11075100	JN997

*Find out our complete range: www.athena.eu | *Per ulteriori informazioni consultate il catalogo online nel nostro sito: www.athena.eu

053752-1052

CYLINDER HEAD GASKET SET - KIT GUARNIZIONI TESTATA NISSAN - RENAULT

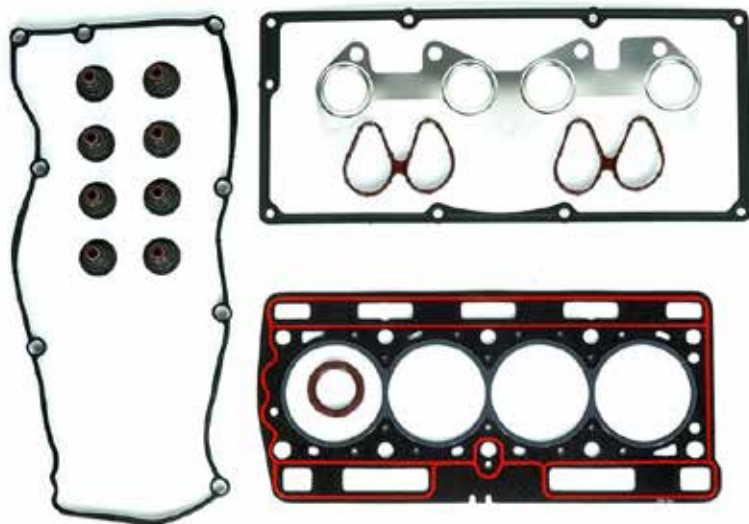

103752-1914

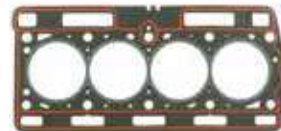

113752-8500



113771-8000



EXPERT'S NOTE - NOTA DELL'ESPERTO
Unified Set with two valve covers: Plastic Cover and Aluminium Cover
Serie unificata con due coperchi valvole: Coperchio in Plastica e Coperchio in Alluminio

ENGINES* | MOTORI*

DISPLACEMENT | CILINDRATA

1.2 8V

CODE | CODICE

D7D 740 - D7D 760
D7F 700 - 701 - 702 - 703 - 704 - 706 - 708 - 710 - 720 - 722 - 726 - 730 - 744 - 746 - 764 - 766 - 780

MODELS* | MODELLI*

NISSAN

KUBISTAR (X76) 1.2 8V

RENAULT

CLIO I (B-C 57- 5-357) 1.2 8V - CLIO II (BB-CB-SB0-1-2) 1.2 8V
KANGOO (KCO-1) - KANGOO RAPID (FC0-1) 1.2 8V
TWINGO I (CO6) 1.2 8V - TWINGO II (CNO) 1.2 8V

DESCRIPTION DESCRIZIONE	P/N		CROSS REFERENCES CORRISPONDENZE			
	GA	OE	RNZ	EK	AJ	PY
CYLINDER HEAD GASKET SET, WITH H.G., WITH OIL SEALS KIT GUARNIZIONI TESTATA, CON T.C., CON PARAOLI	053752-1052	7701472955 10101-00QAK	02-33585-02	181.520 219.240	52206900	
CYLINDER HEAD GASKET, COMPOSITE MATERIAL GUARNIZIONE TESTATA IN MATERIALE COMPOSITO	103752-1914	7700864736 8200034315	61-33585-00	012.361	10105700	BX631
CYLINDER HEAD COVER GASKET, ALUMINIUM COVER GUARNIZIONE COPRITESTATA, COPERCHIO IN ALLUMINIO	113752-8500	7701471213 7700868132 7700106172	71-31651-00	773.310	11075100	JN997
CYLINDER HEAD COVER GASKET, PLASTIC COVER GUARNIZIONE COPRITESTATA, COPERCHIO IN PLASTICA	113771-8000	7701049734	71-34459-00	175.360	11093800	JM5131

*Find out our complete range: www.athena.eu | *Per ulteriori informazioni consultate il catalogo online nel nostro sito: www.athena.eu

053763-1000

CYLINDER HEAD GASKET SET - KIT GUARNIZIONI TESTATA NISSAN - RENAULT

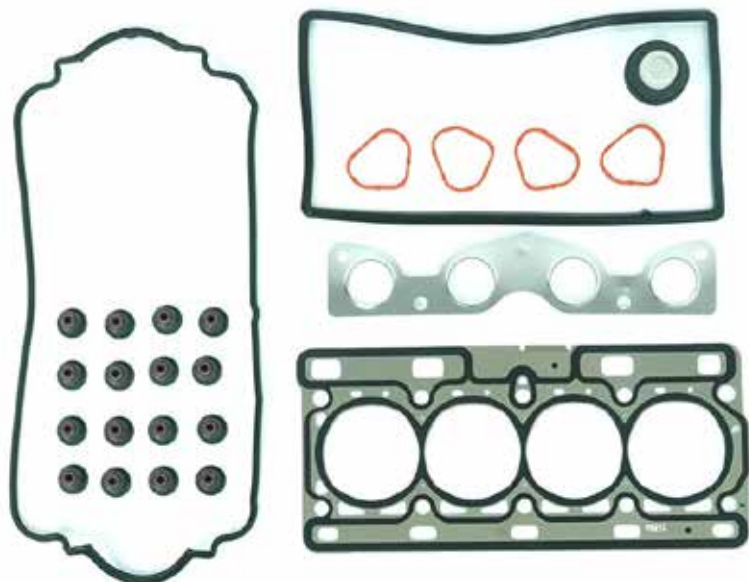

103763-5250

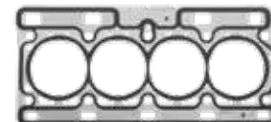

113763-8000



ENGINES* | MOTORI*

DISPLACEMENT | CILINDRATA

1.216V

CODE | CODICE

D4D 700 - D4D 712 - D4D 720 - D4D 754
D4F 702 - D4F 704 - D4F 706 - D4F 714 - D4F 716
Up to engine / Fino motore : 030820 - Up to / Fino a 08.2003

MODELS* | MODELLI*

NISSAN

KUBISTAR (X76) 1.2 16V

RENAULT

CLIO II (BB-CB) 1.2 16V
KANGOO (KC0-1) - KANGOO EXPRESS (FC0-1) 1.2 16V
THALIA I /LB) 1.2 16V - TWINGO I (C06) 1.2 16V

DESCRIPTION DESCRIZIONE	P/N CROSS REFERENCES CORRISPONDENZE					
	GA	OE	RNZ	EK	AJ	PY
CYLINDER HEAD GASKET SET, WITH H.G., WITH OIL SEALS KIT GUARNIZIONI TESTATA, CON T.C., CON PARAOLI	053763-1000	7701473003	02-33740-01	258.850	52204400	CD5981
CYLINDER HEAD GASKET, MLS GUARNIZIONE TESTATA, MLS	103763-5250	8200062273 8200151984 8200049012 8200086698	61-33740-00	177.230	10146700	AD5980
CYLINDER HEAD COVER GASKET GUARNIZIONE COPRITESTATA	113763-8000	7701049888	71-33371-00	194.020	11092600	JM5185

*Find out our complete range: www.athena.eu | *Per ulteriori informazioni consultate il catalogo online nel nostro sito: www.athena.eu

053770-1000

CYLINDER HEAD GASKET SET - KIT GUARNIZIONI TESTATA DACIA - RENAULT



103763-5250

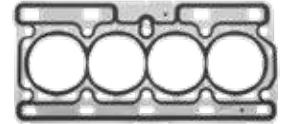

113770-8000



ENGINES* | MOTORI*

DISPLACEMENT | CILINDRATA

1.2 16V

CODE | CODICE

D4F 708 - D4F 722 - D4F 728 - D4F 730 - D4F 732 - D4F 734 - D4F 740 - D4F 742 - D4F 772

MODELS* | MODELLI*

DACIA

LOGAN (LS) 1.2 16V - LOGAN II 1.2 16V - LOGAN MCV II 1.2 16V
LOGAN STEPWAY II 1.2 16V - SANDERO 1.2 16V - SANDERO II 1.2 16V

RENAULT

CLIO II (BB-CB) 1.2 16V - CLIO III (BR0-1-CR0-1) 1.2 16V - CLIO IV (BH) 1.2 16V
KANGOO (KC0-1 - FC0-1) 1.2 16V - MODUS - GRAND MODUS (F-JPO) 1.2 16V
THALIA II (LU) 1.2 16V - TWINGO I (C06) 1.2 16V - TWINGO II (CNO) 1.2 16V

DESCRIPTION DESCRIZIONE	CROSS REFERENCES CORRISPONDENZE					
	GA	OE	RNZ	EK	AJ	PY
CYLINDER HEAD GASKET SET, WITH H.G., WITH OIL SEALS KIT GUARNIZIONI TESTATA, CON T.C., CON PARAOLI	053770-1000	7701475822	02-33740-03	505.050	52242800	CD5980
CYLINDER HEAD GASKET, MLS GUARNIZIONE TESTATA, MLS	103763-5250	8200062273 8200151984 8200049012 8200086698	61-33740-00	177.230	10146700	AD5980
CYLINDER HEAD COVER GASKET GUARNIZIONE COPRITESTATA	113770-8000	7701059314	71-37912-00	522.950	11106900	JM7053

*Find out our complete range: www.athena.eu | *Per ulteriori informazioni consultate il catalogo online nel nostro sito: www.athena.eu

053781-1000

CYLINDER HEAD GASKET SET - KIT GUARNIZIONI TESTATA RENAULT

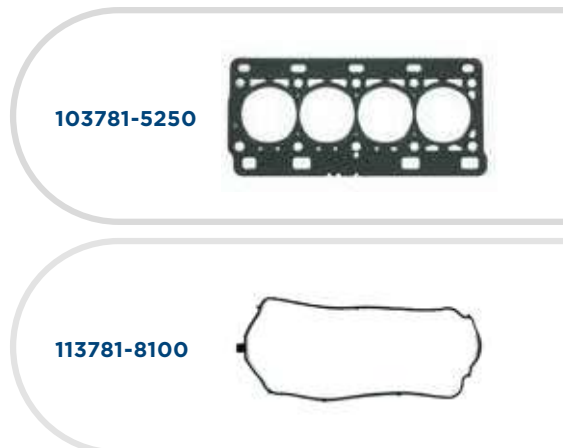

103781-5250



113781-8100



ENGINES* | MOTORI*

DISPLACEMENT | CILINDRATA

1.2 16V

CODE | CODICE

D4F780 - D4F782 - D4F784 - D4F786

MODELS* | MODELLI*

RENAULT

CLIO III 1.2 16V
CLIO SPORTOUR 1.2 16V
MODUS - GRAND MODUS 1.2 16V
TWINGO II 1.2 T. 16V - TWINGO II TCE 100 1.2 16V
WIND 1.2 16V - WIND TCE 100 1.2 16V

DESCRIPTION DESCRIZIONE	P/N		CROSS REFERENCES CORRISPONDENZE			
	GA	OE	RNZ	EK	AJ	PY
CYLINDER HEAD GASKET SET, WITH H.G., WITH OIL SEALS KIT GUARNIZIONI TESTATA, CON T.C., CON PARAOLIO	053781-1000	7701477823	02-35245-01	386.290	52279400	
CYLINDER HEAD GASKET, MLS GUARNIZIONE TESTATA, MLS	103781-5250	8200342238	61-35245-00	386.240	10190600	AH6780
CYLINDER HEAD COVER GASKET GUARNIZIONE COPRITESTATA	113781-8100	8200549617	71-40859-00	374.280	11119200	JM7125

*Find out our complete range: www.athena.eu | *Per ulteriori informazioni consultate il catalogo online nel nostro sito: www.athena.eu

053780-1000

CYLINDER HEAD GASKET SET - KIT GUARNIZIONI TESTATA RENAULT



103780-5250



113780-6212



EXPERT'S NOTE - NOTA DELL'ESPERTO

Cylinder head cover gasket made with improved material compared to OEM
Coperchio valvole con materiale migliorativo rispetto all'OEM

ENGINES* | MOTORI*

DISPLACEMENT | CILINDRATA

1,4 16V

CODE | CODICE

H4J700

MODELS* | MODELLI*

RENAULT

MEGANE III - MEGANE III GRANDTOUR - COUPE* - CC 1.4 TCE 16V
SCENIC III - GRAND SCENIC III 1.4 16V

DESCRIPTION DESCRIZIONE	P/N		CROSS REFERENCES CORRISPONDENZE			
	GA	OE	RNZ	EK	AJ	PY
CYLINDER HEAD GASKET SET, WITH H.G., WITH OIL SEALS KIT GUARNIZIONI TESTATA, CON T.C., CON PARAOLIO	053780-1000	101012709R	02-42145-01	575.920	52343200	
CYLINDER HEAD GASKET, MLS GUARNIZIONE TESTATA, MLS	103780-5250	11044-5H60A	61-42145-00	460.410	10197600	
CYLINDER HEAD COVER GASKET GUARNIZIONE COPRITESTATA	113780-6212	13270-0001R	71-42214-00	573.690	11124100	

*Find out our complete range: www.athena.eu | *Per ulteriori informazioni consultate il catalogo online nel nostro sito: www.athena.eu

053784-1000 DACIA - RENAULT



103784-5303



ENGINES* | MOTORI*

DISPLACEMENT
1.4-1.6 8V
1.4-MPI 8V
1.6-BIFUEL 8V
1.6-LPG 8V

—
K7J 710-714
K7M 690-710-718-732
K7M 750-812

MODELS* | MODELLI*

DACIA

—
DOKKER-EXPRESS 1.6 8V - LOGAN 1.4-MPI 8V - LOGAN 1.6 - BIFUEL 8V - LOGAN EXPRESS-PICKUP 1.4-1.6 8V - LODGY 1.6 - LPG 8V - SANDERO I 1.4-SANDERO I-II 1.6 8V

RENAULT

—
KANGOO-GRAND KANGOO 1.6 8V - KANGOO EXPRESS 1.6 8V - LOGAN I 1.4 8V

DESCRIPTION	P/N	CROSS REFERENCES				
		OE	RNZ	EK	AJ	PY
HEAD SET WITH MLS H.G AND OIL SEALS	053784-1000	6001548043	02-34830-01	458.730	52259700	
MLS H.G 0.3MM	103784-5303	8200296969	61-34830-00	431.551	10177800	AH5170

*Find out our complete range: www.athena.eu | *Per ulteriori informazioni consultate il catalogo online nel nostro sito: www.athena.eu

053769-1000

DACIA - RENAULT



103760-5250



ENGINES* | MOTORI*

DISPLACEMENT
1.6 16V

—
K4M 606-716-760-761-766 - ETC.
K4M 800-801-854-858-866 - ETC.

MODELS* | MODELLI*

DACIA

—
DUSTER 4X4 1.6 16V

RENAULT

—
CLIO III 1.6 16V - FLUENCE 1.6 16V - GRAND SCENIC II-III 1.6 16V - MODUS-GRAND
MODUS 1.6 16V - KANGOO-GRAND KANGOO 1.6 16V - LAGUNA II-III 1.6 16V -
MEGANE II-III 1.6 16V - SCENIC II-III 1.6 16V - TWINGO II 1.6 16V - WIND 1.6 16V

DESCRIPTION	P/N	CROSS REFERENCES				
		OE	RNZ	EK	AJ	PY
HEAD SET WITH MLS H.G AND OIL SEALS	053769-1000	7701474372	02-31675-02	659.250	52260100	
MLS H.G.	103760-5250	7700112739	61-31675-00	071.292	10119500	AC5100

*Find out our complete range: www.athena.eu | *Per ulteriori informazioni consultate il catalogo online nel nostro sito: www.athena.eu

053766-1052

NISSAN - RENAULT

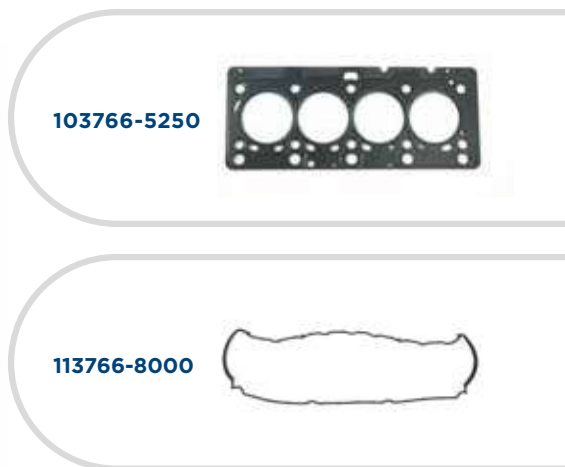

ENGINES* | MOTORI*

DISPLACEMENT
1.5 dCi 8V

—
K9K 702-704-722, etc.
ENG. 040519

MODELS* | MODELLI*

NISSAN

—
ALMERA II 1.5 dCi - KUBISTAR 1.5 dCi - MICRA III 1.5 dCi - NOTE 1.5 dCi

RENAULT

—
CLIO II 1.5 dCi - KANGOO - EXPRESS 1.5 dCi - MEGANE II 1.5 DCI - SCENIC II 1.5 dCi - GRAND SCENIC II 1.5 dCi - THALIA I-II 1.5 dCi

DESCRIPTION	P/N	CROSS REFERENCES				
		OE	RNZ	EK	AJ	PY
HEAD SET WITH MLS H.G AND OIL SEALS	053766-1052 ^A	7701473371 + 8200071111	02-36345-01	434.330 + 262.871	52204500	
MLS HEAD GASKET	103766-5250 ^B	8200071111	61-36345-00	262.871	10146800	AE5200
CYLINDER HEAD COVER	113766-8000	8200117388	71-36442-00	332.500	11092700	JM7054

^A Cancels and supercedes p/n 053766-1000

^B Cancels and supercedes p/n 103766-3850

053776-1000

CYLINDER HEAD GASKET SET - KIT GUARNIZIONI TESTATA NISSAN - RENAULT



103776-5250



113776-8000

EXPERT'S NOTE - NOTA DELL'ESPERTO
Head set with cylinder head gasket made of pre-processed rubber-steel material
Serie smeriglio con guarnizione testata in materiale acciaio-gomma pre-trattato

ENGINES* | MOTORI*

DISPLACEMENT | CILINDRATA

1.5 DS 8V

CODE | CODICE

K9K 278 - 410 - 732 - 734 - 764 - 774 - 780 - 804 - 806 - 812 - 832 - P732

MODELS* | MODELLI*

NISSAN

CUBE 1.5 DCI 8V - JUKE 1.5 DCI 8V - TIIDA 1.5 DCI 8V

RENAULT

CLIO III 1.5 DCI 8V - FLUENCE 1.5 DCI 8V - GRAND SCENIC II-III 1.5 DCI 8V
KANGOO - BE BOP - RAPID - GRAND KANGOO 1.5 DCI 8V
LAGUNA III 1.5 DCI 8V - MEGANE II-III 1.5 DCI 8V
MODUS/GRAND MODUS 1.5 DCI 8V - SCENIC II-III 1.5 DCI 8V

DESCRIPTION DESCRIZIONE	P/N		CROSS REFERENCES CORRISPONDENZE			
	GA	OE	RNZ	EK	AJ	PY
CYLINDER HEAD GASKET SET, WITH H.G., WITH OIL SEALS KIT GUARNIZIONI TESTATA, CON T.C., CON PARAOLI	053776-1000 *A	7701477501 + 8200351353	02-36975-02	382.421		
CYLINDER HEAD GASKET, MLS GUARNIZIONE TESTATA, MLS	103776-5250 *B	8200351353	61-36975-00	338.861	10177900	AG9490
CYLINDER HEAD COVER GASKET GUARNIZIONE COPRITESTATA	113776-8000	7701066400	71-38504-00	318.430	11113100	JM7163

*A Interchangeable with 053793-1000 - Intercambiabile alla 053793-1000

*B Interchangeable with 103793-5250 - Intercambiabile alla 103793-5250

053783-1000 DACIA - NISSAN - RENAULT

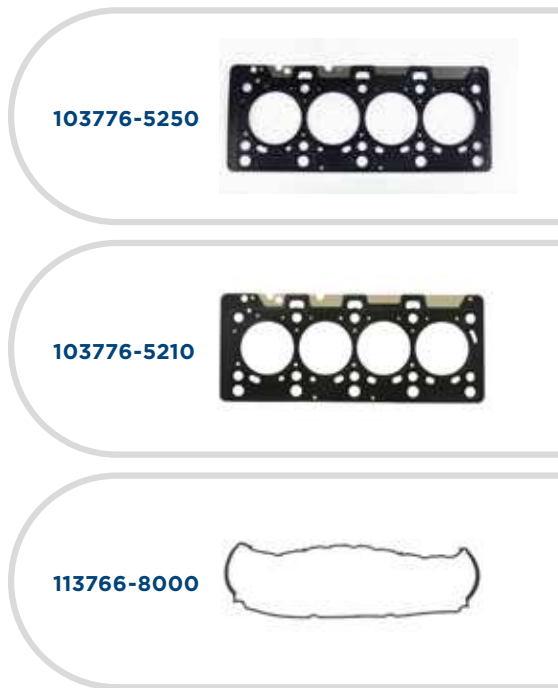

EXPERT'S NOTE - NOTA DELL'ESPERTO

Head set with cylinder head gasket made of pre-processed rubber-steel material
Serie smeriglio con guarnizione testata in materiale acciaio-gomma pre-trattato

ENGINES* | MOTORI*

DISPLACEMENT
1.5 dCi 8V

FROM ENGINE / DAL MOTORE 040520:
K9K 700 - 702 - 704 - 710 - 722
K9K 706 - 712 - 714 - 716 - 718 - 724 - 728 - 729
K9K 740 - 750 - 752 - 760 - 762 - 766 - 768 - 772 - 790 - 792 - 794 - 796
K9K 800 - 802 - 812 - 830 - G724

MODELS* | MODELLI*

DACIA

DUSTER 1.5 DCI 8V - LOGAN I-II - EXPRESS - MCV 1.5 DCI 8V - SANDERO 1.5 DCI 8V

NISSAN

ALMERA II 1.5 DCI 8V - KUBISTAR 1.5 DCI 8V - MICRA III 1.5 DCI 8V
NOTE 1.5 DCI 8V - QASHQAI / QASHQAI 2+ 1.5 DCI 8V

RENAULT

CLIO II-III 1.5 DCI 8V - FLUENCE 1.5 DCI 8V - GRAND SCENIC II-III 1.5 DCI 8V
KANGOO - BE BOP - RAPID - GRAND KANGOO 1.5 DCI 8V
LOGAN I 1.5 DCI 8V - MEGANE II-III 1.5 DCI 8V
MODUS / GRAND MODUS 1.5 DCI 8V - SCENIC II-III 1.5 DCI 8V
THALIA I 1.5 DCI 8V - TWINGO II 1.5 DCI 8V

DESCRIPTION	P/N	CROSS REFERENCES				
		OE	RNZ	EK	AJ	PY
HEAD SET WITH MLS H.G AND OIL SEALS	053783-1000 ^B	7701476729	02-36975-01			
MLS HEAD GASKET THICKNESS 0,7 MM	103776-5250 ^C	8200351353	61-36975-00	688.422	10177900	AG9490
MLS HEAD GASKET THICKNESS 1 MM	103776-5210 ^A		61-36975-10			
CYLINDER HEAD COVER	113766-8000	8200117388	71-36442-00	332.500	11092700	JM7054

^A Can be combined with unified head set without H.G. : 043776-1051, Not included in the kit

^B Interchangeable with 053794-1000 - Intercambiabile alla 053794-1000

^C Interchangeable with 103793-5250 - Intercambiabile alla 103793-5250

043776-1051

DACIA - NISSAN - RENAULT

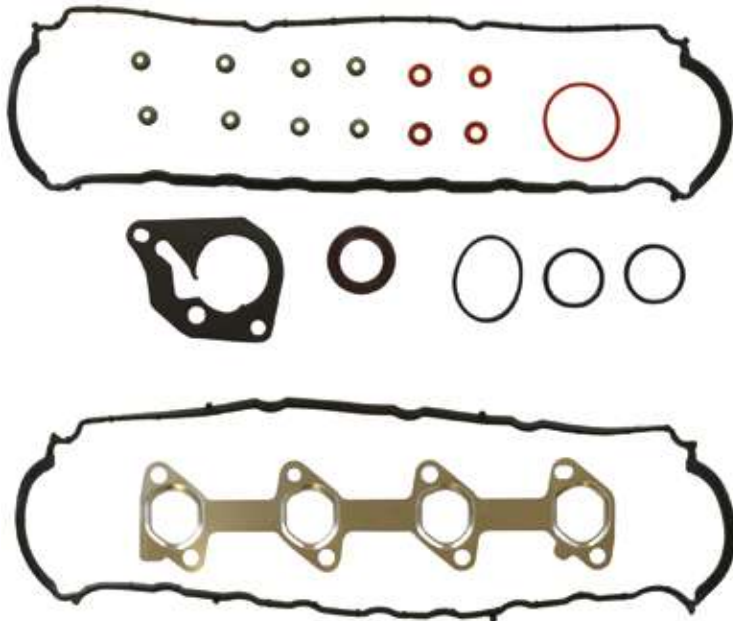

113766-8000



113776-8000



ENGINES* | MOTORI*

DISPLACEMENT
1.5 DCI 8V

—
K9K All Types/Tutti i tipi (Until/Fino al 2009)

MODELS* | MODELLI*

DACIA

—
DUSTER-LOGAN-SANDERO - 1.5 dCi 8V

NISSAN

—
ALMERA-MICRA III-NOTE - 1.5 dCi 8V

RENAULT

—
CLIO-KANGOO-MEGANE - MODUS-SCENIC - 1.5 dCi 8V

DESCRIPTION	P/N	CROSS REFERENCES				
		OE	RNZ	EK	AJ	PY
HEAD SET WITHOUT H.G. WITH OIL SEALS	043776-1051 ^A		02-36345-01 ^B 02-36975-02 ^C 02-36975-01 ^C			
CYLINDER HEAD COVER	113766-8000	8200117388	71-36442-00	332.500	11092700	JM7054
CYLINDER HEAD COVER	113776-8000	7701066400	71-38504-00	318.430	11113100	

^A Unified kit with 2 valve covers

^B with h.g. 61-36345-00

^C with h.g. 61-36975-00

103776-5210

CYLINDER HEAD GASKET - GUARNIZIONE TESTATA NISSAN - RENAULT

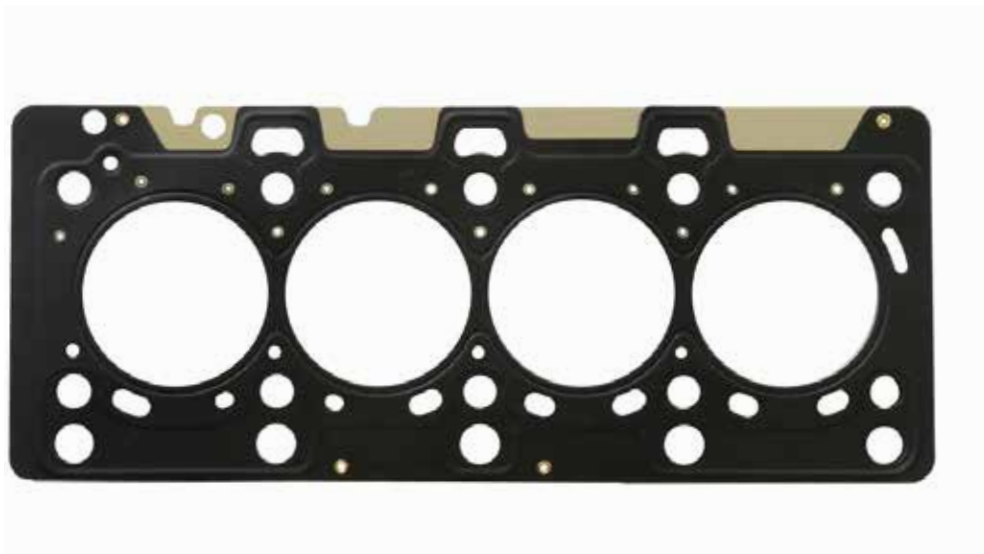

EXPERT'S NOTE - NOTA DELL'ESPERTO

Can be combined with unified head set without C.H.G. 043776-1051
Può essere abbinata al kit guarnizioni unificato senza testa cod. 043776-1051

ENGINES* | MOTORI*

DISPLACEMENT | CILINDRATA

1.5 DS 8V

CODE | CODICE

K9K 276 - 278 - 288 - 292 - 410 - 700 - 702 - 704 - 706 - 708 - 710 - 712
K9K 714 - 716 - 718 - 722 - 724 - 728 - 729 - 732 - 734 - 740 750 - 752
K9K 760 - 762 - 764 - 766 - 768 - 772 - 774 - 780 - 790 - 792 - 794 - 796
K9K 800 - 802 - 804 - 806 - 812 - 830 - 832 - 838 - 840 - F830 - G724 - P732

MODELS* | MODELLI*

DACIA

DUSTER 1.5 DCI 8V - LOGAN I-II - EXPRESS - MCV 1.5 DCI 8V -
SANDERO I-II 1.5 DCI 8V

NISSAN

ALMERA II 1.5 DCI 8V - CUBE 1.5 DCI 8V - JUKE 1.5 DCI 8V - KUBISTAR 1.5 DCI 8V
MICRA III 1.5 DCI 8V - NOTE 1.5 DCI 8V - QASHQAI - QASHQAI 2+ 1.5 DCI 8V
TIIDA 1.5 DCI 8V

RENAULT

CAPTUR I 1.5 DCI 8V - CLIO II-III 1.5 DCI 8V - FLUENCE 1.5 DCI 8V
GRAND SCENIC II-III 1.5 DCI 8V - KANGOO - BE BOP - RAPID 1.5 DCI 8V
GRAND KANGOO 1.5 DCI 8V - LAGUNA III 1.5 DCI 8V - LOGAN I 1.5 DCI 8V
MEGANE II-III 1.5 DCI 8V - MODUS - GRAND MODUS 1.5 DCI 8V
SCENIC II-III 1.5 DCI 8V - THALIA I 1.5 DCI 8V - TWINGO II 1.5 DCI 8V

+0.3 mm thickness cylinder head gasket made of pre-processed rubber-steel material.
Guarnizione testata con spessore maggiorato +0.3 mm in materiale acciaio-gomma pre-trattato.



DESCRIPTION DESCRIZIONE	P/N		CROSS REFERENCES CORRISPONDENZE			
	GA	OE	RNZ	EK	AJ	PY
CYLINDER HEAD GASKET, MLS GUARNIZIONE TESTATA, MLS	103776-5210 *A		61-36975-10			

*A This head gasket is 0,3mm thicker than the standard one - Questa guarnizione testata è 0,3mm più spessa rispetto allo standard.
Interchangeable with 103793-5210 - intercambiabile alla 103793-5210

103793-5210

CYLINDER HEAD GASKET - GUARNIZIONE TESTATA DACIA - NISSAN - RENAULT

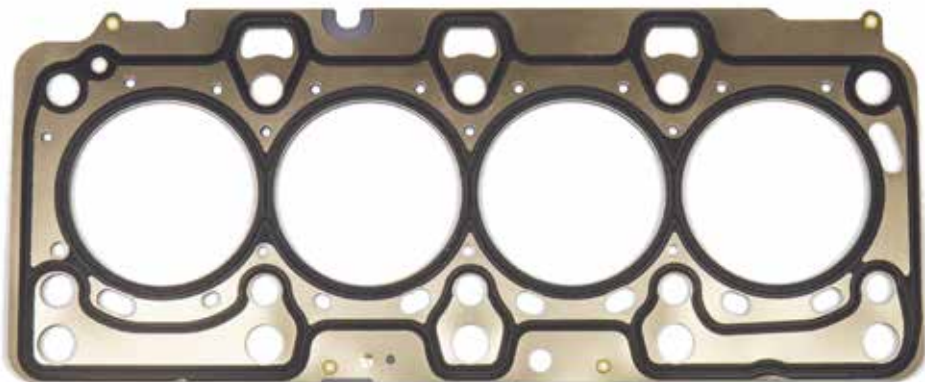

EXPERT'S NOTE - NOTA DELL'ESPERTO

Can be combined with unified head set without C.H.G. 043776-1051

Puo' essere abbinata al kit guarnizione testata unificato senza testa 043776-1051

ENGINES* | MOTORI*

DISPLACEMENT | CILINDRATA

1.5 DS 8V

CODE | CODICE

K9K 276 - 278 - 288 - 292 - 410 - 700 - 702 - 704 - 706 - 708 - 710 - 712
K9K 714 - 716 - 718 - 722 - 724 - 728 - 729 - 732 - 734 - 740 750 - 752
K9K 760 - 762 - 764 - 766 - 768 - 772 - 774 - 780 - 790 - 792 - 794 - 796
K9K 800 - 802 - 804 - 806 - 812 - 830 - 832 - 838 - 840
F830 - G724 - P732

MODELS* | MODELLI*

DACIA

DUSTER 1.5 DCI 8V - LOGAN I-II - EXPRESS - MCV 1.5 DCI 8V -
SANDERO I-II 1.5 DCI 8V

NISSAN

ALMERA II 1.5 DCI 8V - CUBE 1.5 DCI 8V - JUKE 1.5 DCI 8V - KUBISTAR 1.5 DCI 8V
MICRA III 1.5 DCI 8V - NOTE 1.5 DCI 8V - QASHQAI - QASHQAI 2+ 1.5 DCI 8V
TIIDA 1.5 DCI 8V

RENAULT

CAPTUR I 1.5 DCI 8V - CLIO II-III 1.5 DCI 8V - FLUENCE 1.5 DCI 8V
GRAND SCENIC II-III 1.5 DCI 8V - KANGOO - BE BOP - RAPID 1.5 DCI 8V
GRAND KANGOO 1.5 DCI 8V - LAGUNA III 1.5 DCI 8V - LOGAN I 1.5 DCI 8V
MEGANE II-III 1.5 DCI 8V - MODUS-GRAND MODUS 1.5 DCI 8V
SCENIC II-III 1.5 DCI 8V - THALIA I 1.5 DCI 8V - TWINGO II 1.5 DCI 8V

+0.3 mm thickness cylinder head gasket with localized rubber coating.

Guarnizione testata con spessore maggiorato +0.3 mm e deposizione localizzata.



DESCRIPTION DESCRIZIONE	P/N		CROSS REFERENCES CORRISPONDENZE			
	GA	OE	RNZ	EK	AJ	PY
CYLINDER HEAD GASKET, MLS GUARNIZIONE TESTATA, MLS	103793-5210 ^{^A}		61-10063-10	456.710		

^{^A} **This head gasket is 0,3mm thicker than the standard one** - Questa guarnizione testata è 0,3mm più spessa rispetto allo standard.
Interchangeable with 103776-5210 - Intercambiabile alla 103776-5210

053793-1000

CYLINDER HEAD GASKET SET - KIT GUARNIZIONI TESTATA NISSAN - RENAULT



103793-5250



113776-8000



EXPERT'S NOTE - NOTA DELL'ESPERTO

Head set with cylinder head gasket with localized rubber coating.
Serie smeriglio con guarnizione testata con deposizione localizzata.

ENGINES* | MOTORI*

DISPLACEMENT | CILINDRATA

1.5 DS 8V

CODE | CODICE

K9K 278 - 410 - 732 - 734 - 764 - 774 - 780 - 804 - 806 - 812 - 832 - P732

MODELS* | MODELLI*

NISSAN

CUBE 1.5 DCI 8V - JUKE 1.5 DCI 8V - TIIDA 1.5 DCI 8V

RENAULT

CLIO III 1.5 DCI 8V - FLUENCE 1.5 DCI 8V - GRAND SCENIC II-III 1.5 DCI 8V
KANGOO - BE BOP - RAPID - GRAND KANGOO 1.5 DCI 8V
LAGUNA III 1.5 DCI 8V - MEGANE II-III 1.5 DCI 8V
MODUS-GRAND MODUS 1.5 DCI 8V - SCENIC II-III 1.5DCI 8V

DESCRIPTION DESCRIZIONE	P/N		CROSS REFERENCES CORRISPONDENZE			
	GA	OE	RNZ	EK	AJ	PY
CYLINDER HEAD GASKET SET, WITH H.G., WITH OIL SEALS KIT GUARNIZIONI TESTATA, CON T.C., CON PARAOLI	053793-1000 ^A	7701477501 + 110446505R	02-36975-02	382.421	52279500	
CYLINDER HEAD GASKET, MLS GUARNIZIONE TESTATA, MLS	103793-5250 ^B	110446505R 11044-00QAU 11044-00QIL	61-10063-00	688.422	10177900	
CYLINDER HEAD COVER GASKET GUARNIZIONE COPRITESTATA	113776-8000	7701066400	71-38504-00	318.430	11113100	JM7163

^A: Interchangeable with **053776-1000** - Intercambiabile alla 053776-1000

^B: Interchangeable with **103776-5250** - Intercambiabile alla 103776-5250

*Find out our complete range: www.athena.eu | *Per ulteriori informazioni consultate il catalogo online nel nostro sito: www.athena.eu

053794-1000

CYLINDER HEAD GASKET SET - KIT GUARNIZIONI TESTATA DACIA - NISSAN - RENAULT



103793-5250



113766-8000



EXPERT'S NOTE - NOTA DELL'ESPERTO

Head set with cylinder head gasket with localized rubber coating.
Serie smeriglio con guarnizione testata con deposizione localizzata.

ENGINES* | MOTORI*

DISPLACEMENT | CILINDRATA

1.5 DS 8V

CODE | CODICE

K9K 700 - 702 - 704 - 710 - 722 From engine / Dal motore 040520
K9K 706 - 712 - 714 - 716 - 718 - 724 - 728 - 729
K9K 740 - 750 - 752 - 760 - 762 - 766 - 768 - 772 - 790 - 792 - 794 - 796
K9K 800 - 802 - 812 - 830
G724

MODELS* | MODELLI*

DACIA

DUSTER 1.5 DCI 8V - LOGAN I-II - EXPRESS - MCV 1.5 DCI 8V - SANDERO 1.5 DCI 8V

NISSAN

ALMERA II 1.5 DCI 8V - KUBISTAR 1.5 DCI 8V - MICRA III 1.5 DCI 8V
NOTE 1.5 DCI 8V - QASHQAI - QASHQAI 2+ 1.5 DCI 8V

RENAULT

CLIO II-III 1.5 DCI 8V - FLUENCE 1.5 DCI 8V - GRAND SCENIC II-III 1.5 DCI 8V
KANGOO - BE BOP - RAPID - GRAND KANGOO 1.5 DCI 8V
LOGAN I 1.5 DCI 8V - MEGANE II-III 1.5 DCI 8V
MODUS-GRAND MODUS 1.5 DCI 8V - SCENIC II-III 1.5 DCI 8V
THALIA I 1.5 DCI 8V - TWINGO II 1.5 DCI 8V

DESCRIPTION DESCRIZIONE	P/N		CROSS REFERENCES CORRISPONDENZE			
	GA	OE	RNZ	EK	AJ	PY
CYLINDER HEAD GASKET SET, WITH H.G., WITH OIL SEALS KIT GUARNIZIONI TESTATA, CON T.C., CON PARAOLI	053794-1000 ^A	7701476729 + 110446505R		430.330 + 688.422	52259900	
CYLINDER HEAD GASKET, MLS GUARNIZIONE TESTATA, MLS	103793-5250 ^B	110446505R 11044-00QAU 11044-00Q1L	61-10063-00	688.422	10177900	
CYLINDER HEAD COVER GASKET GUARNIZIONE COPRITESTATA	113766-8000	8200117388 8200317650	71-36442-00	332.500	11092700	JM7054

^A: Interchangeable with **053783-1000** - Intercambiabile alla 053783-1000

^B: Interchangeable with **103776-5250** - Intercambiabile alla 103776-5250

053775-1000

DACIA - MERCEDES - RENAULT NISSAN



043775-1099



103775-5250



113775-8100

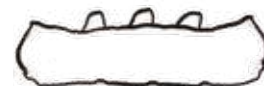

ENGINES* | MOTORI*

DISPLACEMENT

1.5 dCi 8V

CDI 1.5 D 8V

—

K9K 608-612-628-636-646-700-770

772-782-802-808-820-826-834-836-837

846-856-858-884-892-894-896-898

OM 607.951

MODELS* | MODELLI*

DACIA

—

DOKKER - DUSTER 1.5 dCi 8V - LOGAN I-II - LODGY 1.5 dCi 8V - SANDERO I-II 1.5 dCi 8V

MERCEDES

—

A160-A180 CDI-B160-180 CDI 1.5 D 8V - CLA - GLA 180 CDI 1.5 D 8V - CITAN 108-109 -111 CDI 1.5 D 8V

NISSAN

—

CUBE (Z12) - JUKE (F15) 1.5 dCi 8V - PULSAR (C13) - NOTE (E12) 1.5 dCi 8V - QASHQAI-QASHQAI+2 (J10) 1.5 dCi 8V NV 200 / EVALIA 1.5 dCi 8V

RENAULT

—

CAPTUR 1.5 dCi 90 8V - CLIO III - IV - FLUENCE 1.5 dCi 8V - KANGOO-GR. KANGOO 1.5 dCi 8V - LAGUNA-LATITUDE 1.5 dCi 8V - MEGANE III - MODUS 1.5 dCi 8V - SCENIC III-GR. - SCENIC 1.5 dCi 8V - TWINGO II 1.5 dCi 8V

DESCRIPTION	P/N	CROSS REFERENCES				
		OE	RNZ	EK	AJ	PY
HEAD SET WITH MLS H.G AND OIL SEALS	053775-1000	7701479013 + 8200862244				
HEAD SET WITHOUT H.G. WITH OIL SEALS	043775-1099	7701479013	02-37930-01	382.440		
MLS HEAD GASKET	103775-5250	8200862244	61-37930-10	688.412		
CYLINDER HEAD COVER	113775-8100	7701070607	71-40854-00	310.220		

*Find out our complete range: www.athena.eu | *Per ulteriori informazioni consultate il catalogo online nel nostro sito: www.athena.eu

103790-5250

**FIAT GROUP - MERCEDES BENZ
NISSAN - OPEL - RENAULT**

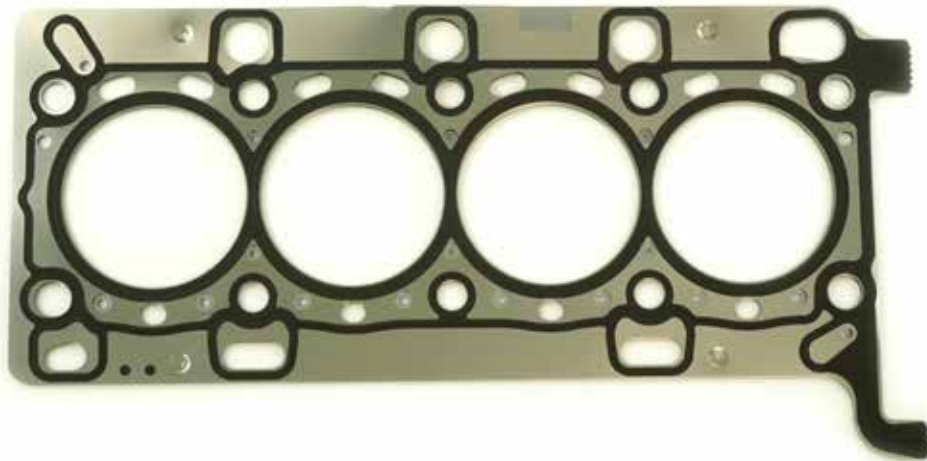

ENGINES* | MOTORI*

DISPLACEMENT
1.6 DCI 16V

R9M - R9M 402-4-8-9-13-14 - 450-2-3 - 622.951 - 626.951

MODELS* | MODELLI*

FIAT

TALENTO 1.6D 16V

MERCEDES BENZ

CLASSE C C180-C200 D - VITO 109-111 CDI 1.6 16V

NISSAN

QASHQAI II - QASHQAI +2 - X-TRAIL 1.6 DCI 16V

OPEL

VIVARO B 1.6 CDTI 16V

RENAULT

ESPACE V - KADJAR - MEGANE III 1.6 DCI 16V - SCENIC III - GRAND SCENIC III-IV - TALISMAN-TRAFIC III 1.6 DCI 16V

DESCRIPTION	P/N	CROSS REFERENCES				
		OE	RNZ	EK	AJ	PY
MLS HEAD GASKET 1,6 MM	103790-5250	6000616557 / 6260160000 / 4423059 / 110445901R	61-10136-00	598.670	10215000	

*Find out our complete range: www.athena.eu | *Per ulteriori informazioni consultate il catalogo online nel nostro sito: www.athena.eu

043758-1000

**MITSUBISHI - NISSAN - OPEL
RENAULT - VOLVO**



ENGINES* | MOTORI*

DISPLACEMENT
1.9 DID
1.9 DTI
1.9 DCI
1.9 TD
—
F9Q

MODELS* | MODELLI*

MITSUBISHI

—
CARISMA - SPACE STAR 1.9 DID

NISSAN

—
PRIMASTAR - PRIMERA 1.9 DTI

OPEL

—
MOVANO - VIVARO 1.9 DTI

RENAULT

—
CLIO II 1.9 DTI - ESCAPE III 1.9 DTI - GRAND SCENIC II 1.9 DCI - KANGOO 1.9 DTI -
LAGUNA 1.9 DTI-DCI - MEGANE I-II 1.9 - DTI-DCI-DCI - SCENIC I-II 1.9 DTI-DCI-DCI
- MASTER II 1.9 DTI

VOLVO

—
S40 - V40 1.9 TD

DESCRIPTION	P/N	CROSS REFERENCES				
		OE	RNZ	EK	AJ	PY
HEAD SET WITHOUT H.G. WITH OIL SEALS	043758-1000	7701470288	02-34409-01	851.021 - 497.890	53010300	
CYLINDER HEAD COVER	113758-8000	7700859651	71-34409-00	851.060	11075000	JM5086

*Find out our complete range: www.athena.eu | *Per ulteriori informazioni consultate il catalogo online nel nostro sito: www.athena.eu

043785-1000

NISSAN - OPEL - RENAULT



ENGINES* | MOTORI*

DISPLACEMENT
2.0 DCI - CDTI 16V

M9R - 610 - 630 - 700 - 721 - 740 - 780 - 800 - 830 etc.

MODELS* | MODELLI*

NISSAN

PRIMASTAR (X83) - X TRAIL (T31) 2.0 DCI 16V QASHQAI - QASHQAI +2 (J10-JJ10) 2.0 DCI 16V

OPEL

VIVARO 2.0 CDTI 16V

RENAULT

ESPACE IV - KOLEOS - LAGUNA II - III
LATITUDE 2.0 DCI 16V - MEGANE II - SCENIC II - GRAND SCENIC II - VEL SATIS 2.0 DCI 16V - TRAFIC II 2.0 DCI 16V

DESCRIPTION	P/N	CROSS REFERENCES				
		OE	RNZ	EK	AJ	PY
HEAD SET WITHOUT CYLINDER HEAD GASKET	043785-1000	4434188 (OPEL) 7701478183 (RENAULT) 10101-00Q0J (NISSAN)				

*Find out our complete range: www.athena.eu | *Per ulteriori informazioni consultate il catalogo online nel nostro sito: www.athena.eu

053785-1000 **NEW**

CYLINDER HEAD GASKET SET - KIT GUARNIZIONI TESTATA NISSAN - RENAULT - MITSUBISHI - OPEL



103785-5250

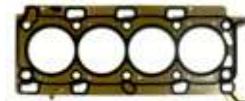

ENGINES* | MOTORI*

DISPLACEMENT | CILINDRATA

—
2.0L 16V

CODE | CODICE

—
M9R B (96-131KW)

MODELS* | MODELLI*

NISSAN

—
PRIMASTAR - QASHQAI - X-TRAIL II 2.0L DCI

OPEL

—
VIVARO (X83) 2.0 CDTI

RENAULT

—
ESPACE IV - SCENIC III - GRAND SCENIC III - KOLEOS I 2.0L DCI
LAGUNA II / III - MEGANE II - TRAFIC II - VEL SATIS 2.0L DCI

DESCRIPTION DESCRIZIONE	P/N		CROSS REFERENCES CORRISPONDENZE			
	GA	OE	RNZ	EK	AJ	PY
CYLINDER HEAD GASKET SET, WITH H.G., WITH OIL SEALS KIT GUARNIZIONI TESTATA, CON T.C., CON PARAOLI	053785-1000	101019367R 7701478184 7701477451 8200498869	02-37000-01	279.770	52260300	
CYLINDER HEAD GASKET, MLS GUARNIZIONE TESTATA, MLS	103785-5250	8200929929 82 00 498 869 11 04 491 99R	61-37000-10	174.425	10190300	

*Find out our complete range: www.athena.eu | *Per ulteriori informazioni consultate il catalogo online nel nostro sito: www.athena.eu

053786-1000 **NEW**

CYLINDER HEAD GASKET SET - KIT GUARNIZIONI TESTATA NISSAN - RENAULT - MITSUBISHI - OPEL



103786-5250

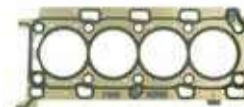

ENGINES* | MOTORI*

DISPLACEMENT | CILINDRATA

2.0L 16V

CODE | CODICE

M9R A (66-110KW)

MODELS* | MODELLI*

NISSAN

PRIMASTAR - QASHQAI - X-TRAIL II 2.0L DCI

OPEL

VIVARO (X83) 2.0 CDTI

RENAULT

ESPACE IV - SCENIC III - GRAND SCENIC III - KOLEOS I 2.0L DCI
LAGUNA II / III - MEGANE II - TRAFIC II - VEL SATIS 2.0L DCI

DESCRIPTION DESCRIZIONE	P/N		CROSS REFERENCES CORRISPONDENZE			
	GA	OE	RNZ	EK	AJ	PY
CYLINDER HEAD GASKET SET, WITH H.G., WITH OIL SEALS KIT GUARNIZIONI TESTATA, CON T.C., CON PARAOLI	053786-1000	4434188 7701478183 7701477450 8200399103	02-37375-01	279.780	52363100	CG9760
CYLINDER HEAD GASKET, MLS GUARNIZIONE TESTATA, MLS	103786-5250	4452368 110448588R 82 00 929 931	61-37375-10	381.752	10190300	AG9760

*Find out our complete range: www.athena.eu | *Per ulteriori informazioni consultate il catalogo online nel nostro sito: www.athena.eu

103785-5250

NISSAN - RENAULT**ENGINES* | MOTORI***

DISPLACEMENT
2.0 DCI 16V

—
M9R 610 - 760 - 800 - 820 - 830 - ETC.

MODELS* | MODELLI*

NISSAN

—
X TRAIL (T31) 2.0 DCI 16V

RENAULT

—
ESPACE IV - KOLEOS - LAGUNA II - III - LATITUDE MEGANE II - III - SCENIC II - III -
VEL SATIS 2.0 DCI 16V

DESCRIPTION	P/N	CROSS REFERENCES				
		OE	RNZ	EK	AJ	PY
MLS HEAD GASKET NOTCH 8 MM	103785-5250	110449199 R 8201073205	61-37000-10	174.425	10178600	

*Find out our complete range: www.athena.eu | *Per ulteriori informazioni consultate il catalogo online nel nostro sito: www.athena.eu

103786-5250

NISSAN - OPEL - RENAULT

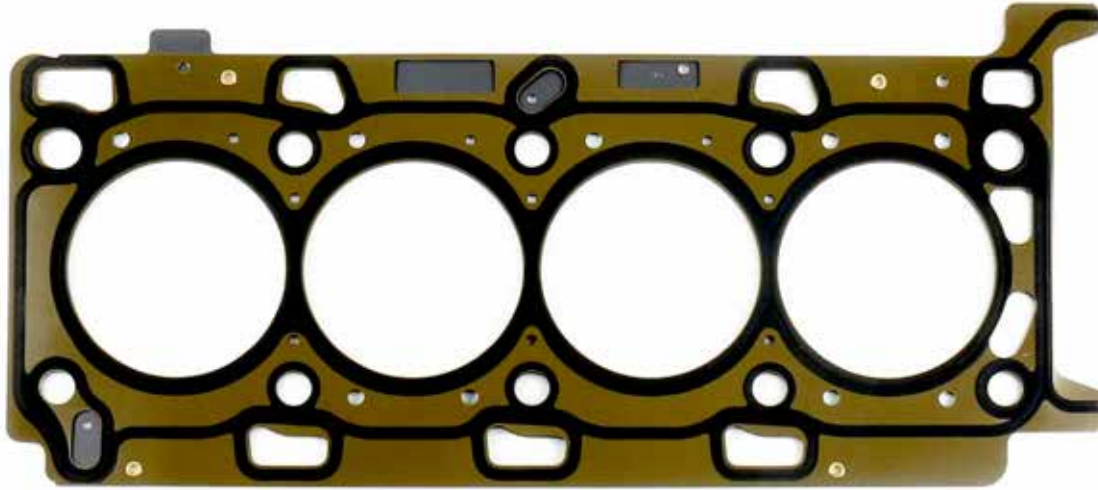

ENGINES* | MOTORI*

DISPLACEMENT
2.0 DCI 16V

M9R 630 - 700 - 740 - 750 - 780 - etc.

MODELS* | MODELLI*

NISSAN

QASHQAI - QASHQAI +2 (J10-JJ10) 2.0 DCI 16V X TRAIL (T31-32) - PRIMASTAR (X83)
2.0 DCI 16V

OPEL

VIVARO 2.0 CDTI 16V

RENAULT

ESPACE IV - LAGUNA II - III - MEGANE II SCENIC II - GRAND SCENIC II
TRAFIC 2.0 DCI 16V

DESCRIPTION	P/N	CROSS REFERENCES				
		OE	RNZ	EK	AJ	PY
MLS HEAD GASKET NOTCH 16 MM	103786-5250	110448588R (RENAULT) 4449223 (OPEL)	61-37375-10	381.752	10190300	AG9760

053772-1000

NISSAN - OPEL - RENAULT

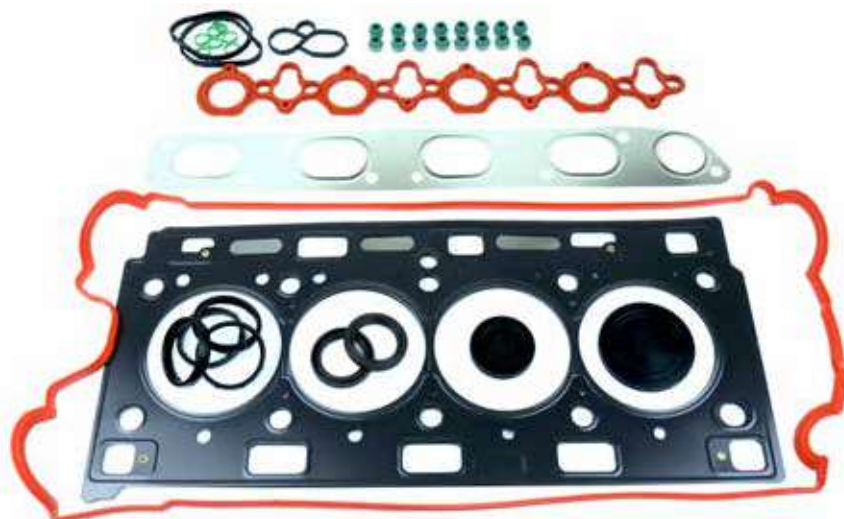

ENGINES* | MOTORI*

DISPLACEMENT
2.5 dCi 16V
2.5 DTI 16V
 —
 G9U 650-720-724
 G9U 730-750-754

MODELS* | MODELLI*

NISSAN
 —
 INTERSTAR 100-120 2.5 dCi 16V - PRIMASTAR 140 2.5 dCi 16V

OPEL
 —
 MOVANO 2.5 DTI 16V - VIVARO 2.5 DTI 16V

RENAULT
 —
 MASTER II-III 2.5 dCi 16V - TRAFIC II-III 2.5 dCi 16V

DESCRIPTION	P/N	CROSS REFERENCES				
		OE	RNZ	EK	AJ	PY
HEAD SET WITH MLS H.G AND OIL SEALS	053772-1000	4433416 + 4403869 (OPEL) 93198084 + 9111869 (OPEL) 7701477813 + 8200406743 (RENAULT)	02-37682-01 + 61-36540-00	399.601 + 517.411	52262000	CE5210
CYLINDER HEAD COVER SET 13 PCS	113764-0000	4506060 9201488 (OPEL) 7701472450 (RENAULT)	15-37682-01	375.500	56032200	HM5290

*Find out our complete range: www.athena.eu | *Per ulteriori informazioni consultate il catalogo online nel nostro sito: www.athena.eu

053789-1000

NISSAN - OPEL - RENAULT



ENGINES* | MOTORI*

DISPLACEMENT
2.3 dCi 16V

M9T 670 672 - 676 - 678 - 680 - 686 - 690 - 692 - 694 - 696 - 698
M9T 870 - 876 - 880 - 890 - 896 - 898

MODELS* | MODELLI*

NISSAN

NV 400 100-125-145 (X62-B) 2.3 dCi 16V

OPEL

MOVANO B (X62) -FWD 2.3 CDTI 16V

RENAULT

MASTER III 100-125-145-150 (JV-EV-FV-HU-UV) 2.3 dCi 16V

DESCRIPTION	P/N	CROSS REFERENCES				
		OE	RNZ	EK	AJ	PY
HEAD SET WITH MLS H.G AND OIL SEALS	053789-1000	4420676+4422084 / 7701479334+8200805657	02-42140-01	521.150		
MLS HEAD GASKETS	103789-5250	4422084 / 8200805657	61-42140-10	718.690		

*Find out our complete range: www.athena.eu | *Per ulteriori informazioni consultate il catalogo online nel nostro sito: www.athena.eu

083785-9970

CRANKCASE GASKET SET - KIT GUARNIZIONI MONOBLOCCO MERCEDES BENZ - NISSAN - OPEL - RENAULT



EXPERT'S NOTE - NOTA DELL'ESPERTO

Unified gasket set for passenger cars and commercial vehicles
Serie unificata per auto e veicoli commerciali

ENGINES* | MOTORI*

DISPLACEMENT | CILINDRATA

2.0 - 2.3 DCI 16V

CODE | CODICE

OM 699.300 - OM 699.301 - MID - M9R - M9T - YS23DDT - YS23DDTT

MODELS* | MODELLI*

MERCEDES BENZ

CLASSE X (470) X220D - X250D 2.3 D 16V

NISSAN

NP 300 NAVARA PICK-UP 2.3 DCI 16V
QASHQAI - QASHQAI +2 - X-TRAIL 2.0 DCI 16V
NV 400 100-110-125-130-140-145-160-165-170 2.3 DCI 16V
PRIMASTAR 90-115-120 2.3 DCI 16V

OPEL

MOVANO B 2.3 CDTI 16V - VIVARO A 2.0 CDTI 16V

RENAULT

ALASKAN 163-190 2.3 DCI 16V
ESPACE IV - KOLEOS I-II - LAGUNA II-III - LATITUDE 2.3 DCI 16V
MEGANE II-III - SCENIC II-III - GRAND SCENIC II-III 2.0 DCI 16V
VEL SATIS 2.0 DCI 16V
TRAFIC II 90-115 2.0 DCI 16V
MASTER III 100-110-125-135-145-150-165-170 2.3 DCI 16V

DESCRIPTION DESCRIZIONE	P/N		CROSS REFERENCES CORRISPONDENZE			
	GA	OE	RNZ	EK	AJ	PY
CRANKCASE GASKET SET KIT GUARNIZIONI MONOBLOCCO	083785-9970	101013580R	08-38518-01	384.340	54155400/54189800 + 71012300	EG9760

*Find out our complete range: www.athena.eu | *Per ulteriori informazioni consultate il catalogo online nel nostro sito: www.athena.eu

103792-5250

CYLINDER HEAD GASKET - GUARNIZIONE TESTATA
MERCEDES - NISSAN - OPEL - RENAULT

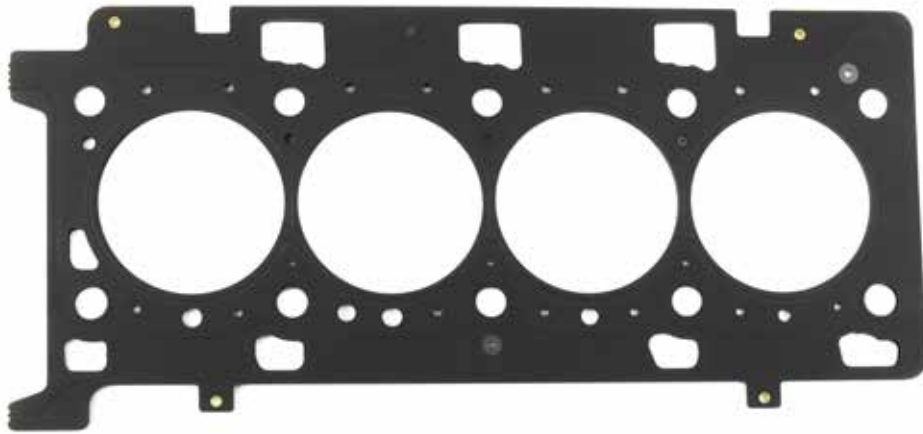

ENGINES* | MOTORI*

DISPLACEMENT | CILINDRATA

2.3 DS 16V

CODE | CODICE

M9T 700 - M9T 702 - M9T 704 - M9T 706 - M9T 708 - M9T 710 - M9T 716
 OM 699.300 - OM 699.301 - YS 23 DDT

MODELS* | MODELLI*

MERCEDES

CLASSE X 220D 2.3 D 16V - CLASSE X 250D 2.3 D 16V

NISSAN

NP 300 NAVARA 2.3 DCI 16V
 NV 400 130 - 135 - 145 - 150 - 160 - 165 - 175 2.3 DCI 16V

OPEL

MOVANO B 2.3 CDTI FWD 16V

RENAULT

ALASKAN 2.3 DCI 16V
 MASTER III 110 - 130 - 135 - 145 - 150 - 165 - 170 2.3 DCI 16V

DESCRIPTION DESCRIZIONE	P/N		CROSS REFERENCES CORRISPONDENZE			
	GA	OE	RNZ	EK	AJ	PY
CYLINDER HEAD GASKET, MLS GUARNIZIONE TESTATA, MLS	103792-5250	11044-0228R 11044-48995R 11044-00Q1M	61-10268-00	925.750	10224200	

*Find out our complete range: www.athena.eu | *Per ulteriori informazioni consultate il catalogo online nel nostro sito: www.athena.eu

054517-1052
SMART-MCC



104517-5250

ENGINES* | MOTORI*

DISPLACEMENT
 1.0
 —
 M132.910

MODELS* | MODELLI*

SMART-MCC
 —
 FORTWO CABRIO (W451) 1.0 - FORTWO COUPE (W451) 1.0

DESCRIPTION	P/N	CROSS REFERENCES					
		OE	RNZ	EK	AJ	PY	FM
HEAD SET WITH MLS H.G	054517-1052 ^A			743.520 ^B			
MLS HEAD GASKET	104517-5250 ^C	1320160120	61-37560-00	380.830	10180100		AH6000

^A Cancels and supercedes p/n 054517-1000. with rubber Cylinder Head Cover, OE 1320160021, our 114517-8000.

^B Without cylinder head cover gasket

^C Cancels and supercedes p/n 104517-3850.

053923-1000

SUZUKI

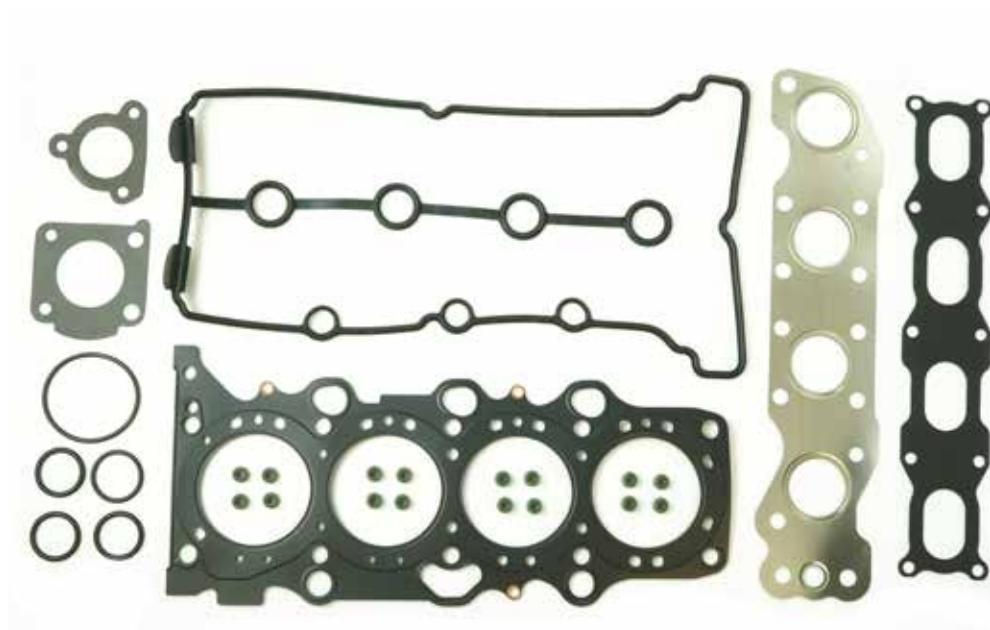

ENGINES* | MOTORI*

DISPLACEMENT

1.3 - 1.6 16V

—

M13A - M16A

MODELS* | MODELLI*

SUZUKI

—

VITARA - GRAND VITARA II (JB416-APK416) 1.6 16V - IGNIS I (RG413) 1.3 16V -
 LIANA (RH413) 1.3 16V-(RH416) 1.6 16V -
 SX4 (RW416) 1.6 VVT 16V
 SX4 S-CROSS (AKK416) 1.6 16V - SWIFT III-IV (RS413-RS416) 1.3-1.6 16V

DESCRIPTION	P/N	CROSS REFERENCES				
		OE	RNZ	EK	AJ	PY
HEAD SET WITH MLS H.G	053923-1000	11400-69853	02-53640-02	302.680	52292300	

054416-1000

TOYOTA



104416-5303



ENGINES* | MOTORI*

DISPLACEMENT
1.0 16V
—
1SZ-FE

MODELS* | MODELLI*

TOYOTA
—
ECHO - VITZ - YARIS 1.0 16V

DESCRIPTION	P/N	CROSS REFERENCES				
		OE	RNZ	EK	AJ	PY
HEAD SET WITH MLS H.G	054416-1000	04112-23040	02-53155-01	182.150	52231800	CD5380
MLS H.G.	104416-5303	11115-23090	61-53155-00	N.A.	N.A.	N.A.

*Find out our complete range: www.athena.eu | *Per ulteriori informazioni consultate il catalogo online nel nostro sito: www.athena.eu

054417-1000
TOYOTA

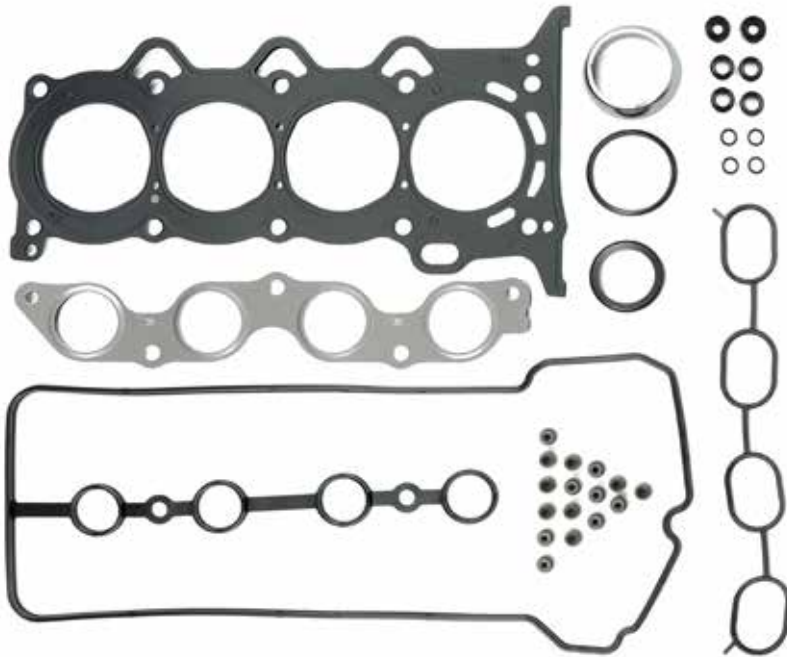

ENGINES* | MOTORI*

DISPLACEMENT
1.3 - 1.5 16V
—
1NZ-FE 2NZ-FE

MODELS* | MODELLI*

TOYOTA
—
ECHO - VITZ - YARIS 1.3 - 1.5 16V

DESCRIPTION	P/N	CROSS REFERENCES				
		OE	RNZ	EK	AJ	PY
HEAD SET WITH MLS H.G.	054417-1000	04112-21040	02-53135-01	170.010	52163000	CB5750
MLS H.G.	104417-5250	1115-21040 1115-21050 1115-21080 1115-21090 1115-21091	61-53135-00	169.750	N.A.	AB5750

*Find out our complete range: www.athena.eu | *Per ulteriori informazioni consultate il catalogo online nel nostro sito: www.athena.eu

054459-1000

DAIHATSU - TOYOTA**ENGINES* | MOTORI***DISPLACEMENT
1.3 16V—
KE3 - VE - VET - VEZ - 2SZ - FE**MODELS* | MODELLI*****DAIHATSU**

—

COPEN - EXTOL - MATERIA - SIRION - TERIOS - YRV 1.3 16V

TOYOTA

—

YARIS (P1-P9) 1.3 VVT-i 16V

DESCRIPTION	P/N	CROSS REFERENCES				
		OE	RNZ	EK	AJ	PY
HEAD SET WITH MLS H.G	054459-1000	04112-0J080 04112-97401	02-53275-01	486.000	52211200	

*Find out our complete range: www.athena.eu | *Per ulteriori informazioni consultate il catalogo online nel nostro sito: www.athena.eu

054420-1000

TOYOTA



104420-5250



ENGINES* | MOTORI*

DISPLACEMENT
1.4 - 1.6 - 1.8 16V

—
1ZZ-FE - 3ZZ-FE - 4ZZ-FE

MODELS* | MODELLI*

TOYOTA

—
AURIS 1.4 16V - AVENSIS 1.6 - 1.8 16V - CELICA 1.8 16V - COROLLA 1.4 - 1.6 16V - CO-ROLLA VERSO 1.6 - 1.8 16V - MR2 1.8 16V - RAV 4 II 1.8 16V

DESCRIPTION	P/N	CROSS REFERENCES				
		OE	RNZ	EK	AJ	PY
HEAD SET WITH MLS H.G AND OIL SEALS	054420-1000	04112-22060	02-53140-01	169.740	52163500	CB5760
MLS H.G.	104420-5250	1111522041 111150D010 1111522050	61-53140-00	141.970	10122100	N.A.

044431-1000 MINI - TOYOTA



104431-5251



104431-5252



104431-5253



ENGINES* | MOTORI*

DISPLACEMENT
1.4 D 8V

MINI W17D14A - TOYOTA 1ND-TV

MODELS* | MODELLI*

MINI

ONE D 1.4 D 8V

TOYOTA

VERSO 1.4 D 8V - YARIS 1.4 D 8V

DESCRIPTION	P/N	CROSS REFERENCES				
		OE	RNZ	EK	AJ	PY
HEAD SET WITHOUT H.G.	044431-1000	04112-33021	02-53558-01	715.800	53016400	CG7600
MLS HEAD GASKET TH. 0,85 MM - 3 NOTCHES	104431-5251	11115-33021C0	61-53375-00	574.200	10151800	AG7600
MLS HEAD GASKET TH. 0,90 MM - 4 NOTCHES	104431-5252	11115-33021D0	61-53375-10	574.210	10151810	AG7610
MLS HEAD GASKET TH. 0,95 MM - 5 NOTCHES	104431-5253	11115-33021E0	61-53375-20	574.220	10151820	AG7620

*Find out our complete range: www.athena.eu | *Per ulteriori informazioni consultate il catalogo online nel nostro sito: www.athena.eu

044447-1000

TOYOTA



104447-5212



ENGINES* | MOTORI*

DISPLACEMENT
2.0 TD 16V
—
ICD - FTV

MODELS* | MODELLI*

TOYOTA
—
AVENSIS 2.0 TD - D4D 2.0 TD 16V - COROLLA 2.0 TD 16V - PREVIA 2.0 TD - D4D 2.0 TD 16V - RAV 4 II 2.0 TD 16V

DESCRIPTION	P/N	CROSS REFERENCES				
		OE	RNZ	EK	AJ	PY
HEAD SET WITHOUT H.G. WITH OIL SEALS	044447-1000	04112-0B010	02-53098-02	478.930	53014500	CG7491
MLS HEAD GASKET TH. 1,2 MM - 5 NOTCHES	104447-5212	11115-27010-E0	61-53145-40	428.550	10123340	AG7510

044462-1000

TOYOTA

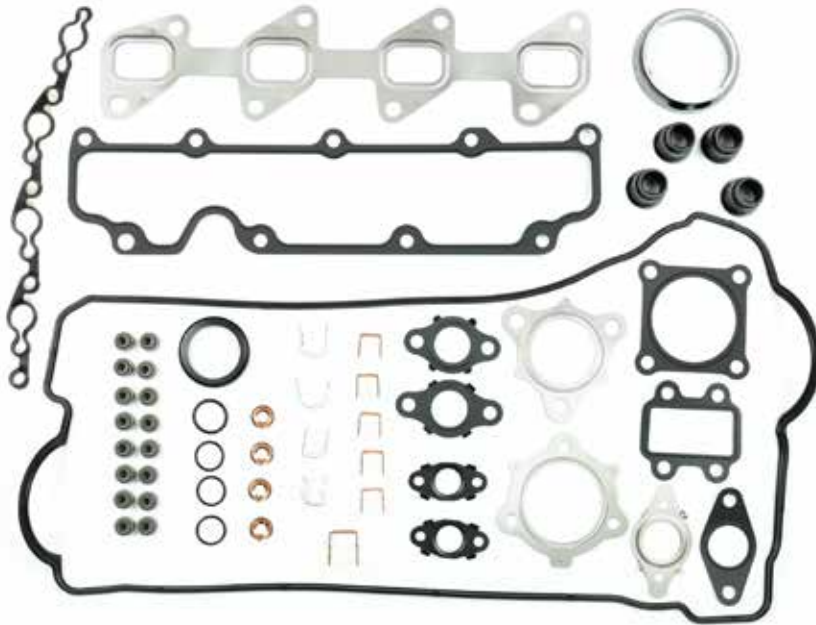

104462-5212



ENGINES* | MOTORI*

DISPLACEMENT
2.0 - 2.2 D 16V

—
1AD-FTV - 2AD-FHV-FTV

MODELS* | MODELLI*

TOYOTA

—
AURIS - AVENSIS 2.0 D-4D 16V - 2.2 D-4D-CAT 16V COROLLA - RAV 4 III 2.2 D-4D-CAT
16V - RAV 4 IV 2.0 D4-D 4WD

DESCRIPTION	P/N	CROSS REFERENCES				
		OE	RNZ	EK	AJ	PY
HEAD SET WITHOUT H.G.	044462-1000	04112 - OR031 OR111 - OR140 ECC	02-53930-01	308.520	53026000	
MLS HEAD GASKET TH. 1,2 MM - 5 NOTCHES	104462-5212	11115-26051EO 11115-26052EO	61-53930-40	286.760	10180740	AH6990

*Find out our complete range: www.athena.eu | *Per ulteriori informazioni consultate il catalogo online nel nostro sito: www.athena.eu

044465-1099

TOYOTA



ENGINES* | MOTORI*

DISPLACEMENT
3.0 D ID 16V
—
1KD-FTV

MODELS* | MODELLI*

TOYOTA
—
DYNA 3.0 D4D 16V- HILUX VII 3.0 D-4D-4WD 16V
LAND CRUISER 90 3.0 D-4D-4WD 16V - LAND CRUISER PRADO 3.0 D-4D 16V

DESCRIPTION	P/N	CROSS REFERENCES				
		OE	RNZ	EK	AJ	PY
HEAD SET WITHOUT H.G. WITH OIL SEALS	044465-1099	04112-30331-2	02-54011-01		53017000	CG7520

104465-5251

TOYOTA



ENGINES* | MOTORI*

DISPLACEMENT
3.0 D ID 16V
 —
 1KD-FTV

MODELS* | MODELLI*

TOYOTA
 —
 DYNA 3.0 D4D 16V - HILUX VII 3.0 D-4D-4WD 16V - LAND CRUISER 90 3.0 D-4D-4WD
 16V - LAND CRUISER PRADO 3.0 D-4D 16V

DESCRIPTION	P/N	CROSS REFERENCES				
		OE	RNZ	EK	AJ	PY
MLS HEAD GASKET TH. 0,85 MM 1 NOTCH	104465-5251	11115-0L020AO	61-53980-00	588.820	10159700	AG7520
MLS HEAD GASKET TH. 0,90 MM 2 NOTCHES	104465-5252	11115-0L020BO	61-53980-10	588.830	10159710	AG7530
MLS HEAD GASKET TH. 0,95 MM 3 NOTCHES	104465-5253	11115-0L020CO	61-53980-20	354.270	10159720	AG7540
MLS HEAD GASKET TH. 1 MM 3+1 NOTCHES	104465-5254	11115-0L020DO	61-53980-30	588.840	10159730	AG7550
MLS HEAD GASKET TH. 1,05 MM 3+2 NOTCHES	104465-5255	11115-0L020EO	61-53980-40	588.850	10159740	AG7560

*Find out our complete range: www.athena.eu | *Per ulteriori informazioni consultate il catalogo online nel nostro sito: www.athena.eu

054786-1052 **NEW**

CYLINDER HEAD GASKET SET - KIT GUARNIZIONI TESTATA VW GROUP



104786-5250



ENGINES* | MOTORI*

DISPLACEMENT | CILINDRATA

1.2 12V

CODE | CODICE

AZQ - BME - BXV - BZG - CEVA - CGPA - CGPB - CGPC - CHTA - CJLA - CJLB

MODELS* | MODELLI*

SEAT

CORDOBA (6L2) 1.2 12V - IBIZA III (6L1) 1.2 12V - IBIZA IV (6P1) 1.2 12V
IBIZA IV SPORTCOUPE (6P5) 1.2 12V - TOLEDO IV (KG3) 1.2 12V

SKODA

FABIA I (6Y2-3-5) 1.2 12V - FABIA II (542-545) 1.2 12V
RAPID (NH1-3) 1.2 12V - ROOMSTER (5J) 1.2 12V

VOLKSWAGEN

POLO (9N-6R1-6C1) 1.2 12V

DESCRIPTION DESCRIZIONE	P/N		CROSS REFERENCES CORRISPONDENZE			
	GA	OE	RNZ	EK	AJ	PY
CYLINDER HEAD GASKET SET, WITH H.G. KIT GUARNIZIONI TESTATA, CON T.C.	054786-1052 ^{*A}		02-36045-01	515.202	52227700	CF5990
CYLINDER HEAD GASKET, MLS GUARNIZIONE TESTATA, MLS	104786-5250 ^{*B}	03E103383F 03E103383H	61-36045-00	461.831	10162200	AF5990

^{*A} Cancels and supercedes 054786-1000 - annulla e sostituisce 054786-1000

^{*B} Cancels and supercedes 104786-3850 - annulla e sostituisce 104786-3850

054788-5251

VW GROUP

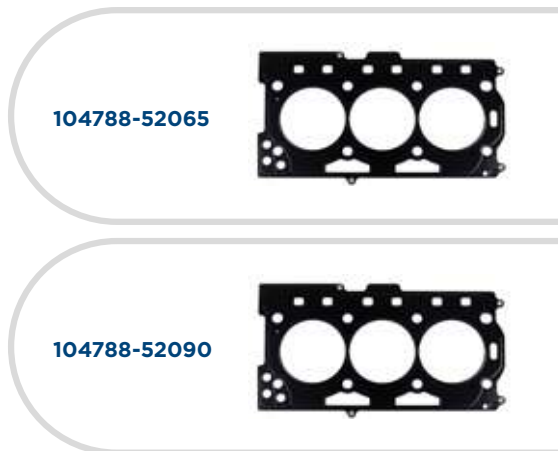
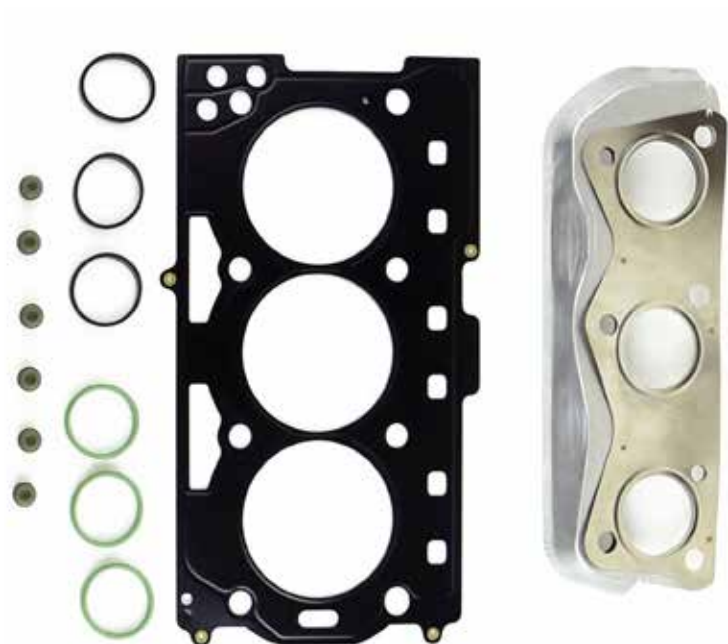

ENGINES* | MOTORI*

DISPLACEMENT
1.2 6V

AWY - BBM - BMD - CHFA - CHF13

MODELS* | MODELLI*

SEAT

IBIZA IV 1.2 6V

SKODA

FABIA 1.2 6V

VW

FOX II 1.2 6V - POLO 1.2 6V

DESCRIPTION	P/N	CROSS REFERENCES				
		OE	RNZ	EK	AJ	PY
HEAD SET WITH MLS H.G - UNIFIED	054788-5251 ^A		02-36050-01	546.070 546.080	52228000	CG8840
MLS HEAD GASKET THICKNESS 0,65 MM	104788-52065 ^B	03D 103 383G	61-36050-00	877.232	10162500	AG8840
MLS HEAD GASKET THICKNESS 0,90 OVERSIZED + 0,25 MM	104788-52090 ^C					

^A Cancels and supercedes p/n 054788-1000

^B Cancels and supercedes p/n 104788-3850

^C Not included in the set

054773-1052

VW GROUP

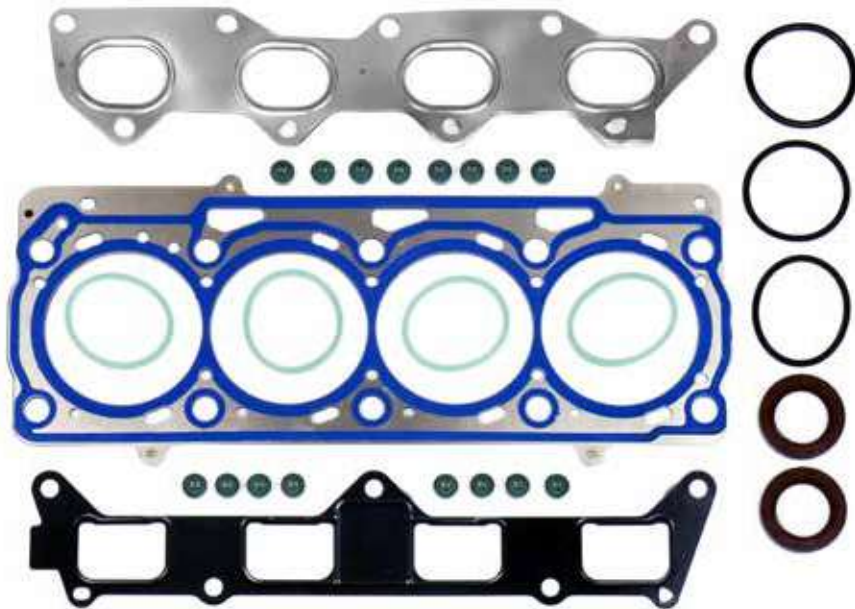

ENGINES* | MOTORI*

DISPLACEMENT
1.4I 16V

AFK - AHW - AKQ - ANM - AUA - BBY - BCA CGGA - CMAA

MODELS* | MODELLI*

AUDI

A2 1.4I 16V

SEAT

ALTEA AROSA CORDOBA IBIZA
LEON 1.4I 16V

SKODA

FABIA OCTAVIA ROOMSTER 1.4I 16V

VW

BORA GOLF LUPO POLO 1.4I 16V

DESCRIPTION	P/N	CROSS REFERENCES				
		OE	RNZ	EK	AJ	PY
HEAD SET WITH MLS H.G AND OIL SEALS	054773-1052 ^A		02-34075-01	167.770	52237400	CB5700
MLS HEAD GASKET	104773-5250 ^B	036103383AJ-AM	61-34075-00	148.331	10131000	AB5701

^A Interchangeable with p/n 054773-1000

^B Interchangeable with p/n 104773-3850

084773-1000 VW GROUP



ENGINES* | MOTORI*

DISPLACEMENT
1.4i - 1.6i 16V

AFK - AHW - AKQ - ANM - AUA - BBY - BCA - CGGA - CMAA

MODELS* | MODELLI*

AUDI

A2 1.4i 16V

SEAT

ALTEA - CORDOBA - IBIZA IV-V 1.4i 16V - LEON II -
TOLEDO II 1.4i - 1.6i 16V

SKODA

FABIA - OCTAVIA I-II - ROOMSTER 1.4i 16V

VW

GOLF IV-V - LUPO - POLO - TOURAN 1.4i-1.6i 16V -
NEW BEETLE 1.4i 16V

DESCRIPTION	P/N	CROSS REFERENCES				
		OE	RNZ	EK	AJ	PY
CRANKCASE GASKET SET	084773-1000 ^A	036198011	08-34320-01 ^B	303.951 ^B	54139200 ^B	EB5700 ^B

^A With rear Integrated crankshaft oil seal p/n 997013-6900

^B Rear integrated crankshaft oil seal not included

054217-1000 VW GROUP

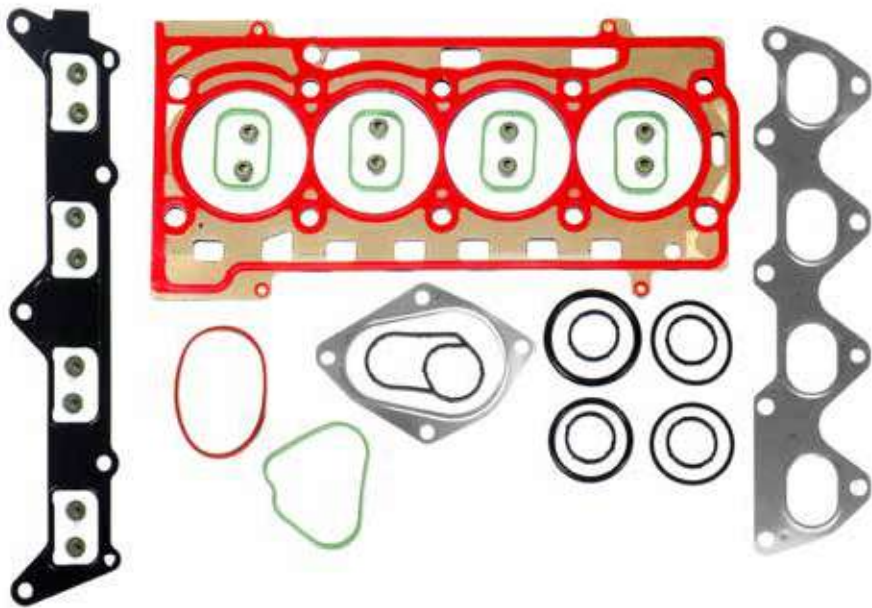

ENGINES* | MOTORI*

DISPLACEMENT
1.4 TSI-TFSI 16V

—
BLG - BMY - CAVD - CAXA - CAXC - CMSA
CMSB - CNVA - CTHD

MODELS* | MODELLI*

AUDI

—
A1 - A3 1.4 TFSI 16V

SEAT

—
ALTEA - LEON - TOLEDO III-IV 1.4 TSI 16V

SKODA

—
OCTAVIA - RAPID - SUPERB - YETI 1.4 TSI 16V

VW

—
EOS - GOLF V-VI-PLUS - JETTA III-IV - PASSAT SCIROCCO 1.4 - TSI 16V - TIGUAN 1.4
TSI 16V FINO 06.2011

DESCRIPTION	P/N	CROSS REFERENCES				
		OE	RNZ	EK	AJ	PY
HEAD SET WITH MLS H.G. (ORIGINAL PROD.)	054217-1000			741.800		
HEAD SET WITH MLS H.G. (ORIGINAL PROD.) AND TIMING COVER GASKET	054217-1042			741.800 + 660.300		
MLS HEAD GASKET (ORIGINAL PROD.)	104217-3850 ^A	03C103383AM-R		492.641		
TIMING COVER GASKET	424783-8500	03C109287F-G	71-36772-00	660.300		

^A Head gasket with 8-point knurl.

054227-1000/52

VW GROUP

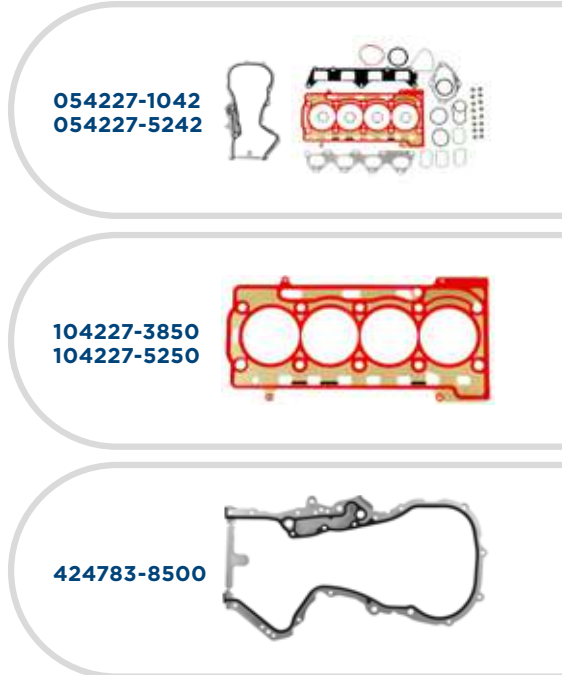
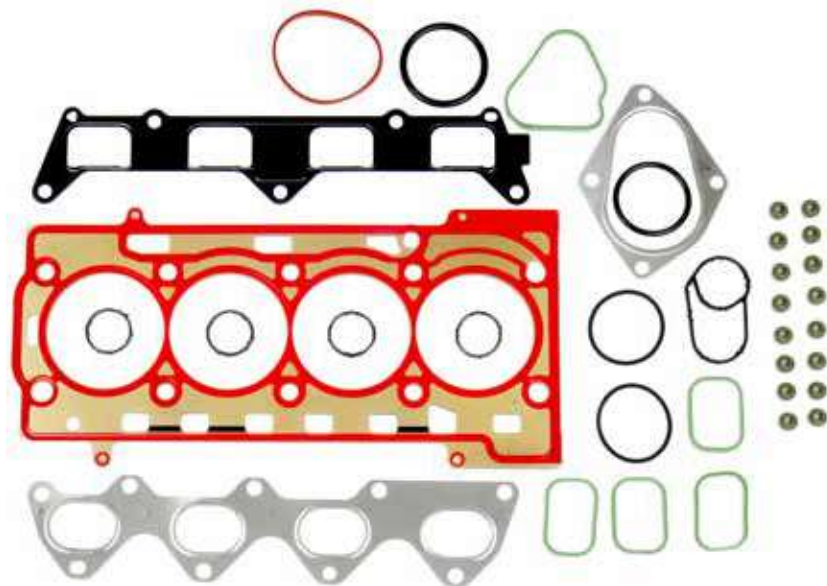

ENGINES* | MOTORI*

DISPLACEMENT

1.4 TSI - TFSI-TSI MULTIFUEL 16V

—
BLG - BMY - BWK - CAVA - CAVB - CAVC- CAVE CAVF - CAVG - CAXA -CNUB - CNWA -
CNWB CTHA-B-C-D-E-F-G - CTJA-B-C - CTKA

MODELS* | MODELLI*

AUDI

—
A1 1.4 TFSI 16V

SEAT

—
ALHAMBRA - IBIZA V 1.4 TSI 16V

SKODA

—
FABIA 1.4 TSI 16V

VW

—
BEETLE - EOS - GOLF V-VI-PLUS - PASSAT JETTA III-IV - POLO - SCIROCCO - SHARAN -
TIGUAN 4MOTION 1.4 TSI 16V DAL 06.2011

DESCRIPTION	P/N	CROSS REFERENCES				
		OE	RNZ	EK	AJ	PY
HEAD SET WITH MLS H.G. (ORIGINAL PROD.)	054227-1000			236.760		
HEAD SET WITH MLS H.G 104227-5250	054227-1052			236.760		
HEAD SET WITH MLS H.G. (ORIGINAL PROD.) AND TIMING COVER GASKET	054227-1042			236.760 + 660.300		
HEAD SET WITH MLS H.G 104227-5250 AND TIMING COVER GASKET	054227-5242			236.760 + 660.300		
MLS HEAD GASKET (ORIGINAL PROD.)	104227-3850	03C103383AE-AH	61-37045-10	732.841		
MLS HEAD GASKET	104227-5250	03C103383AE-AH	61-37045-10	732.841		
TIMING COVER GASKET	424783-8500	03C109287F-G	71-36772-00	660.300		

*Find out our complete range: www.athena.eu | *Per ulteriori informazioni consultate il catalogo online nel nostro sito: www.athena.eu

084227-1000
VW GROUP

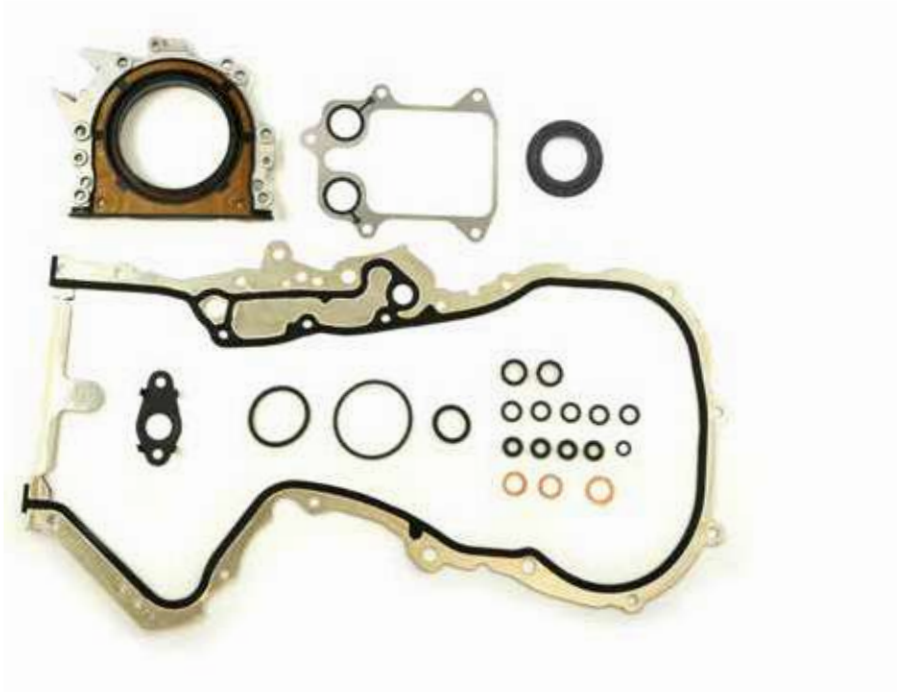

ENGINES* | MOTORI*

DISPLACEMENT
1.4 TSI - TFSI 16V

—
BLG - BMY - BWK - CAVA - CAVB - CAVC - CAVE - CAVF - CAVG - CAXA - CNUB -
CNWA - CNWB - CTHA - CTJA - CTKA

MODELS* | MODELLI*

AUDI

—
A1 - A3 1.4 TFSI 16V

SEAT

—
ALHAMBRA - ALTEA - IBIZA V - LEON - TOLEDO III-IV 1.4 TSI 16V

SKODA

—
FABIA II - OCTAVIA - RAPID - SUPERB II - YETI 1.4 TSI 16V

VW

—
BEETLE - GOLF V-VI - JETTA III-IV 1.4 TSI 16V
PASSAT - POLO - SHARAN - TIGUAN 1.4 TSI 16V

DESCRIPTION	P/N	CROSS REFERENCES				
		OE	RNZ	EK	AJ	PY
CRANKCASE GASKET SET	084227-1000			246.680	54155000 / 54162700	

With rear integrated crankshaft oil seal p/n 997021-8500

054783-1000

VW GROUP

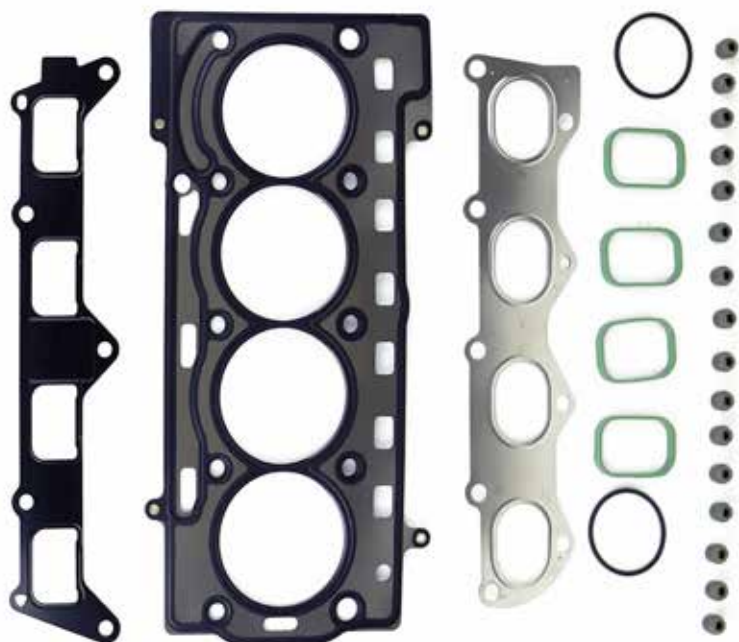

054783-1052



104783-3850



104783-5250



ENGINES* | MOTORI*

DISPLACEMENT
1.4 - 1.6 FSI 16V

AXU - BAG - BKG - BLF - BLN - BLP

MODELS* | MODELLI*

AUDI

A3 1.6I FSI 16V

SKODA

OCTAVIA 1.6I FSI 16V

VW

EOS - GOLF V 1.4I - 1.6I FSI 16V
GOLF PLUS 1.4I - 1.6I FSI 16V - JETTA III 1.6 FSI 16V - PASSAT 1.6I FSI 16V - POLO 1.4I FSI 16V
- TOURAN 1.6I FSI 16V

DESCRIPTION	P/N	CROSS REFERENCES				
		OE	RNZ	EK	AJ	PY
HEAD SET WITH MLS H.G. (ORIGINAL PROD.)	054783-1000		02-34280-01	517.171	52241300 52229600	CG8850
HEAD SET WITH MLS H.G.	054783-1052		02-34280-01	517.171	52241300 52229600	CG8850
MLS HEAD GASKET (ORIGINAL PROD.)	104783-3850	03C 103 383 C-D	61-34280-00	497.810	10162900	AG8850
MLS HEAD GASKET	104783-5250	03C 103 383 C-D	61-34280-00	497.810	10162900	AG8850

*Find out our complete range: www.athena.eu | *Per ulteriori informazioni consultate il catalogo online nel nostro sito: www.athena.eu

084232-1000
VW GROUP



ENGINES* | MOTORI*

DISPLACEMENT
1.6 FSI 16V
—
BAG - BLF - BLP

MODELS* | MODELLI*

AUDI

—
A3 1.6 FSI 16V (UNTIL 8P-4-103-000)

SKODA

—
OCTAVIA II 1.6 FSI 16V AUTOMATIC TRANSMISSION

VW

—
EOS (UNTIL 1T-4-270.000) - GOLF V (UNTIL 1K-4-600.000) 1.6 FSI 16V
PASSAT 1.6 FSI 16V AUTOMATIC TRANSMISSION
TOURAN 1.6 FSI 16V (UNTIL 1T-4-270.000)

DESCRIPTION	P/N	CROSS REFERENCES				
		OE	RNZ	EK	AJ	PY
CRANKCASE GASKET SET	084232-1000 ^A			748.030	54134900 ^B	

^A With rear integrated crankshaft oil seal p/n 997013-6900

^B IOS seal not included

054763-1052

VW GROUP



ENGINES* | MOTORI*

DISPLACEMENT
1.6i 8V
 —
 AEH - AKL

MODELS* | MODELLI*

AUDI
 —
 A3 1.6i 8V

SEAT
 —
 CORDOBA - IBIZA - LEON - TOLEDO 1.6i 8V

SKODA
 —
 OCTAVIA 1.6i 8V

VW
 —
 BORA - GOLF IV - POLO 1.6i 8V

DESCRIPTION	P/N	CROSS REFERENCES				
		OE	RNZ	EK	AJ	PY
HEAD SET WITH MLS H.G AND OIL SEALS	054763-1052 ^A	06A198012	02-31280-01		52139900	CY980

^A Interchangeable with p/n 054763-1000

*Find out our complete range: www.athena.eu | *Per ulteriori informazioni consultate il catalogo online nel nostro sito: www.athena.eu

054777-1052
VW GROUP



ENGINES* | MOTORI*

DISPLACEMENT
1.6i 8V

AVU - AYD - BFQ - BFS - BGU - BSE - BSF
CCSA - CHGA - CMXA

MODELS* | MODELLI*

AUDI

—
A3 1.6i 8V

SEAT

—
ALTEA - LEON II - TOLEDO III 1.6i 8V

SKODA

—
OCTAVIA II 1.6i 8V

VW

—
BORA - GOLF IV-V - JETTA 1.6i 8V - NEW BEETLE - PASSAT - TOURAN CADDY 1.6i 8V

DESCRIPTION	P/N	CROSS REFERENCES				
		OE	RNZ	EK	AJ	PY
HEAD SET WITH MLS H.G AND OIL SEALS	054777-1052 ^A		02-31280-05	041.731	52211900	CC5222

^A Cancels and supercedes p/n 054777-1000

054778-1052

VW GROUP

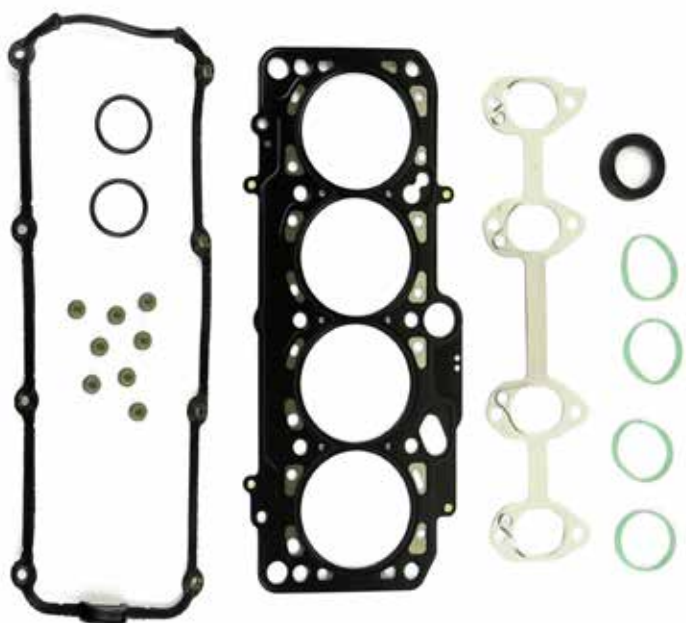

ENGINES* | MOTORI*

DISPLACEMENT
1.6i 8V
 —
 APF - AUR - AWH

MODELS* | MODELLI*

AUDI
 —
 A3 1.6i 8V

SEAT
 —
 CORDOBA - IBIZA 1.6i 8V

SKODA
 —
 OCTAVIA II 1.6i 8V

VW
 —
 BORA - GOLF IV - NEW BEETLE - POLO 1.6i 8V

DESCRIPTION	P/N	CROSS REFERENCES				
		OE	RNZ	EK	AJ	PY
HEAD SET WITH MLS H.G AND OIL SEALS	054778-1052 ^A		02-31280-04		52162700	CC5221

^ACancels and supercedes p/n 054778-1000

*Find out our complete range: www.athena.eu | *Per ulteriori informazioni consultate il catalogo online nel nostro sito: www.athena.eu

054795-1052
VW GROUP



ENGINES* | MOTORI*

DISPLACEMENT
1.6i 8V
 —
 AHL - ANA - ARM

MODELS* | MODELLI*

AUDI
 —
 A4 1.6i 8V

VW
 —
 PASSAT 1.6i 8V

DESCRIPTION	P/N	CROSS REFERENCES				
		OE	RNZ	EK	AJ	PY
HEAD SET WITH MLS H.G AND OIL SEALS	054795-1052 ^A		02-31280-02	698.430		CC5220

^A Cancels and supercedes p/n 054795-1000

054799-1052
VW GROUP

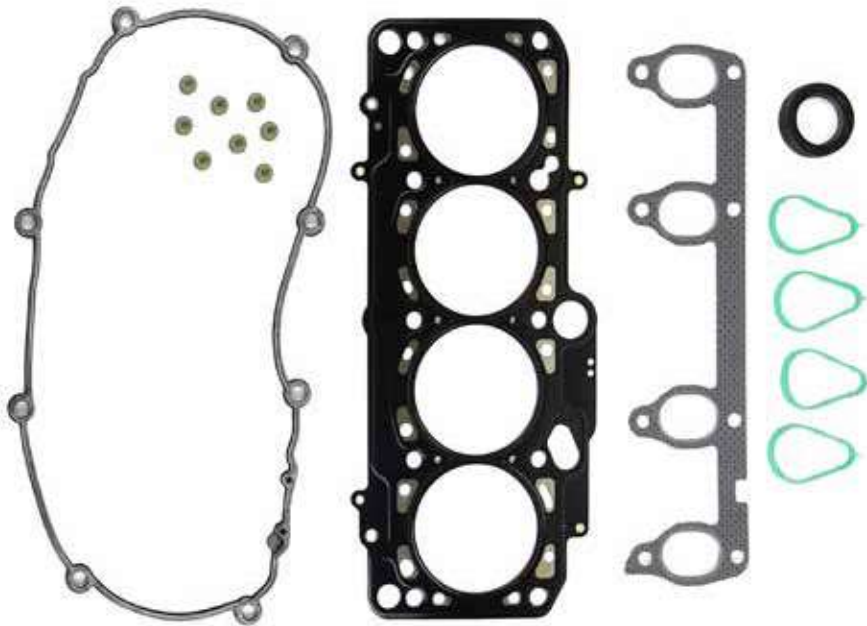

ENGINES* | MOTORI*

DISPLACEMENT
1.6i 8V
 —
 ALZ Until/Fino a T. 8E-4-090000

MODELS* | MODELLI*

AUDI
 —
 A4 1.6i 8V
VW
 —
 PASSAT 1.6i 8V

DESCRIPTION	P/N	CROSS REFERENCES				
		OE	RNZ	EK	AJ	PY
HEAD SET WITH MLS H.G AND OIL SEALS	054799-1052 ^A		02-31280-03	497.800	52212000	CC5223

^ACancels and supercedes p/n 054799-1000

*Find out our complete range: www.athena.eu | *Per ulteriori informazioni consultate il catalogo online nel nostro sito: www.athena.eu

084763-1000

VW GROUP



ENGINES* | MOTORI*

DISPLACEMENT
1.6i 8V

AEH - AHL - AKL - ALZ - ANA - APF - ARM - AUR - AVU - AWH - AYD
BFQ - BFS - BGU - BSE - BSF - CCSA - GHGA - CMXA

MODELS* | MODELLI*

AUDI

A3 - A4 - AVANT 1.6i 8V

SEAT

ALTEA - CORDOBA - IBIZA - LEON-II - TOLEDO II-III 1.6i 8V

SKODA

OCTAVIA I-II 1.6i 8V

VW

GOLF IV-V - JETTA - NEW BEETLE - PASSAT - POLO - TOURAN 1.6i 8V

DESCRIPTION	P/N	CROSS REFERENCES				
		OE	RNZ	EK	AJ	PY
CRANKCASE GASKET SET	084763-1000 ^A	06A198011	08-35053-01 ^B	339.610	54128000 ^B	EC080 ^B

^A With rear Integrated crankshaft oil seal p/n 997014-6900

^B Rear integrated crankshaft oil seal not included

104763-5250
VW GROUP



ENGINES* | MOTORI*

DISPLACEMENT
1.6i 8V

—
 AEH - AKL - APF - BGU - BSE - CCSA - CHGA CMXA ETC.

MODELS* | MODELLI*

AUDI

—
 A3 - A4 1.6i 8V

SEAT

—
 ALTEA - CORDOBA - IBIZA - LEON - TOLEDO 1.6i 8V

SKODA

—
 OCTAVIA 1.6i 8V

VW

—
 BORA - GOLF IV - V 1.6i 8V - JETTA III - NEW BEETLE -
 PASSAT 1.6i 8V - POLO - TOURAN - CADDY 1.6i 8V

DESCRIPTION	P/N	CROSS REFERENCES				
		OE	RNZ	EK	AJ	PY
MLS HEAD GASKET	104763-5250 ^A	06B103383D-G-H	61-31280-00	475.920	10102600	AY980

^A Interchangeable with p/n 104763-3850

*Find out our complete range: www.athena.eu | *Per ulteriori informazioni consultate il catalogo online nel nostro sito: www.athena.eu

054115-1000
VW GROUP



ENGINES* | MOTORI*

DISPLACEMENT
1.6 8V
 —
 BAH

MODELS* | MODELLI*

SEAT
 —
 CORDOBA - IBIZA III 1.6

DESCRIPTION	P/N	CROSS REFERENCES				
		OE	RNZ	EK	AJ	PY
HEAD SET WITH MLS H.G AND OIL SEALS	054115-1000		02-37485-01	582.820	52249400	

*Find out our complete range: www.athena.eu | *Per ulteriori informazioni consultate il catalogo online nel nostro sito: www.athena.eu

054769-1052

VW GROUP



104769-5250

ENGINES* | MOTORI*

DISPLACEMENT
1.6 - 1.8i 8V

AAM - ABM - ABS - ACC - ADA - ADZ

MODELS* | MODELLI*

AUDI

80 - 80 AVANT 1.6 8V

SEAT

CORDOBA - IBIZA II - TOLEDO 1.8i 8V

VW

GOLF III - PASSAT - POLO - VENTO 1.8i 8V

DESCRIPTION	P/N	CROSS REFERENCES				
		OE	RNZ	EK	AJ	PY
HEAD SET WITH MLS H.G AND OIL SEALS	054769-1052 ^A	051 198 012D	02-31175-01	183.870	52181200	DZ910
MLS HEAD GASKET	104769-5250 ^B	050103383A-B	61-31175-00	137.285	10133800	BZ910

^A Cancels and supercedes p/n 054769-1000

^B Cancels and supercedes p/n 104769-3850

054767-1052

VW GROUP

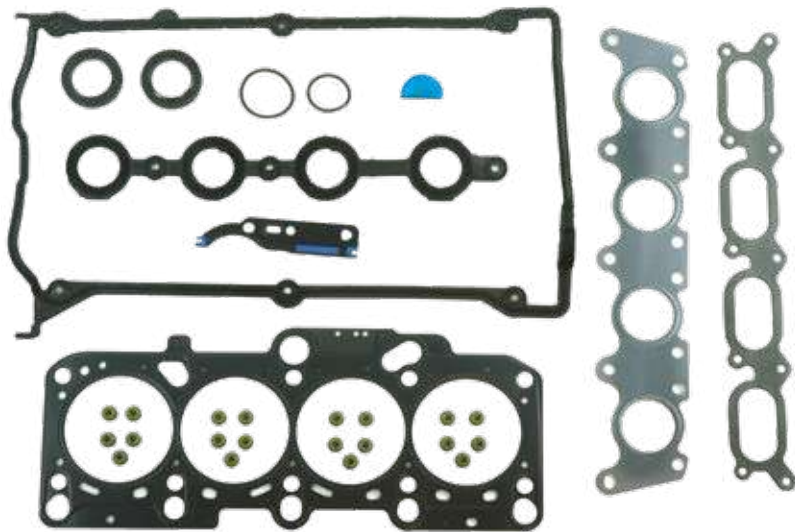

ENGINES* | MOTORI*

DISPLACEMENT
1.8i 20V

ADR-AEB-AFY-AGN-AGU-AJH-AJL-AMK-ANB
ARG-BBU-CFMA

MODELS* | MODELLI*

AUDI

A3 - A4 - A6 - TT 1.8i 20V

SEAT

ALHAMBRA - CORDOBA - IBIZA - LEON TOLEDO 1.8i 20V

SKODA

OCTAVIA - SUPERB 1.8i 20V

VW

BORA - GOLF IV - PASSAT - POLO - SHARAN 1.8i 20V

DESCRIPTION	P/N	CROSS REFERENCES				
		OE	RNZ	EK	AJ	PY
HEAD SET WITH MLS H.G AND OIL SEALS	054767-1052 ^A	058198012 058198025A	02-31955-01	264.730	52145000	CY970
MLS HEAD GASKET	104767-5250 ^B	058103383M-K	61-31955-10	366.670	10102700	AY970

^A Interchangeable with p/n 054767-1000

^B Interchangeable with p/n 104767-3850

054792-1052

VW GROUP

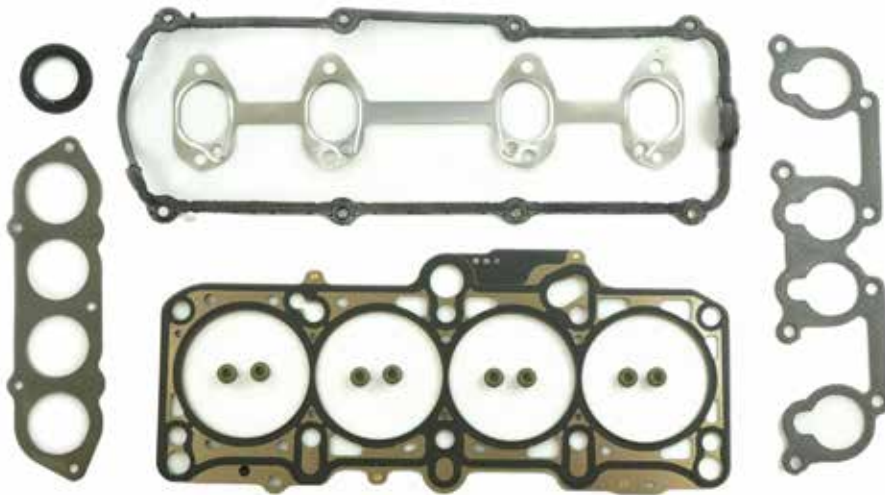

104792-5250



ENGINES* | MOTORI*

DISPLACEMENT
2.0i 8V
—
APK - AQY - AZH

MODELS* | MODELLI*

SKODA
—
FABIA - OCTAVIA 2.0i 8V
VW
—
BORA - GOLF IV - NEW BEETLE 2.0i 8V

DESCRIPTION	P/N	CROSS REFERENCES				
		OE	RNZ	EK	AJ	PY
HEAD SET WITH MLS H.G AND OIL SEALS	054792-1052 ^A		02-34140-02	169.410	52228800	
MLS HEAD GASKET	104792-5250 ^B	06A103383L-AN-AS	61-34140-10	235.831	10121500	AB5370

^A Cancels and supercedes p/n 054792-1000

^B Cancels and supercedes p/n 104792-3850

054221-1052

NEW

CYLINDER HEAD GASKET SET - KIT GUARNIZIONI TESTATA VW GROUP

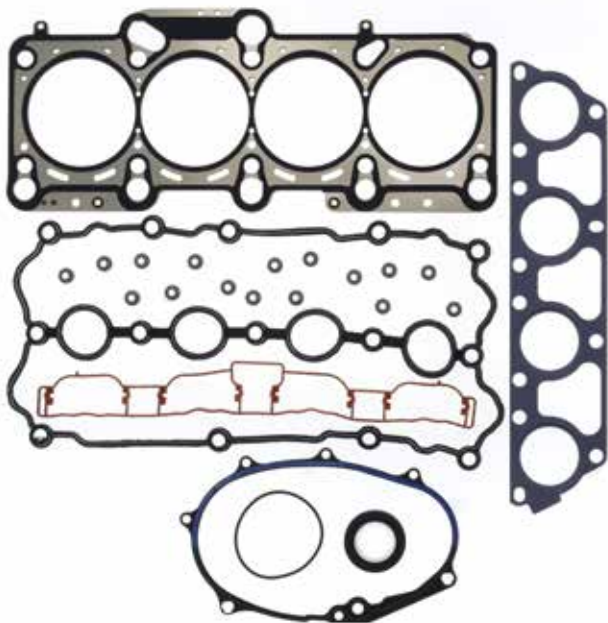

104221-5250



114221-8000

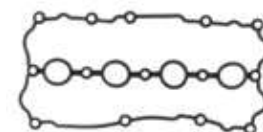

ENGINES* | MOTORI*

DISPLACEMENT | CILINDRATA

2.0 16V

CODE | CODICE

BLR - BLX - BLY - BVX - BVY - BVZ

MODELS* | MODELLI*

AUDI

A3 2.0 FSI 16V

SEAT

ALTEA 2.0 FSI 16V - LEON (1P1) 2.0 FSI 16V - TOLEDO (5P2) 2.0 FSI 16V

SKODA

OCTAVIA II 2.0 FSI 16V

VOLKSWAGEN

EOS 2.0 FSI 16V - GOLF V 2.0 FSI 16V - JETTA III 2.0 FSI 16V
PASSAT (B6) 2.0 FSI 16V - TOURAN (1T1 / 1T2) 2.0 FSI 16V

DESCRIPTION DESCRIZIONE	P/N		CROSS REFERENCES CORRISPONDENZE			
	GA	OE	RNZ	EK	AJ	PY
CYLINDER HEAD GASKET SET, WITH H.G., WITH OIL SEALS KIT GUARNIZIONI TESTATA, CON T.C., CON PARAOLI	054221-1052 ^{*A}		02-36030-02	718.430	52239200 52259300	
CYLINDER HEAD GASKET, MLS GUARNIZIONE TESTATA, MLS	104221-5250 ^{*B}	06D103383L	61-36030-00	149.720	10166800	AG9600
CYLINDER HEAD COVER GASKET GUARNIZIONE COPRITESTATA	114221-8000	06D103483E	71-36047-00	502.990	11105400	JM7078

*A: **Cancels and supercedes 054221-1000** - Annulla e sostituisce 054221-1000

*B: **Cancels and supercedes 104221-3850** - Annulla e sostituisce 104221-3850

054230-1052

VW GROUP

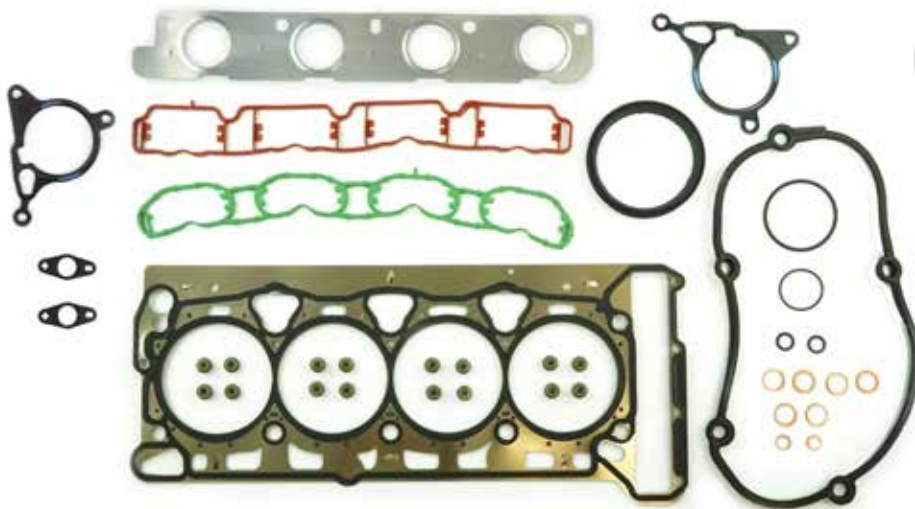

ENGINES* | MOTORI*

DISPLACEMENT
1.8 - 2.0 TSI - TFSI 16V

CAWA - CAWB - CCZA - CDAA - CDNB - CDZA etc.

MODELS* | MODELLI*

AUDI

A3 - A4 - A5 1.8-2.0 TFSI 16V - A6 - Q3 - Q5 2.0 TFSI 16V

SEAT

ALHAMBRA - ALTEA XL - EXEO - LEON 1.8 TSI 16V - 2.0 TFSI 16V

SKODA

OCTAVIA II - SUPERB II 1.8-2.0 TSI 16V

VW

AMAROK - GOLF V-VI 1.8 - 2.0 - JETTA III-IV - PASSAT 1.8 - 2.0 - TIGUAN 2.0 TSI-TFSI 16V

DESCRIPTION	P/N	CROSS REFERENCES				
		OE	RNZ	EK	AJ	PY
HEAD SET WITH MLS H.G AND OIL SEALS	054230-1052		02-37475-01	244.890	52270600	
MLS HEAD GASKET	104230-5250	06H103383AF	61-37475-00	685.662	10195800	AH5380

*Find out our complete range: www.athena.eu | *Per ulteriori informazioni consultate il catalogo online nel nostro sito: www.athena.eu

044218-1099

VW GROUP

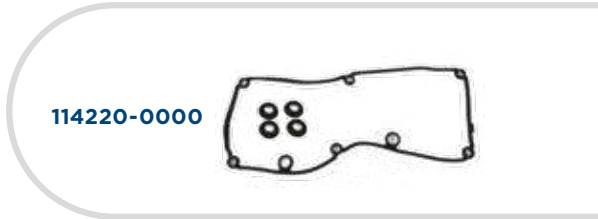

ENGINES* | MOTORI*

DISPLACEMENT
1.6 TDI 16V
—
CAYA-B-C-D-E-CLNA

MODELS* | MODELLI*

AUDI

—
A1 - A3 1.6 TDI 16V

SEAT

—
ALTEA - IBIZA V 1.6 TDI 16V - LEON II - TOLEDO IV 1.6 TDI 16V

SKODA

—
FABIA II - OCTAVIA II 1.6 TDI 16V - RAPID - ROOMSTER 1.6 TDI 16V - SUPERB - YETI 1.6 TDI 16V

VW

—
BEETLE - CADDY III 1.6 TDI 16V - GOLF VI - GOLF PLUS 1.6 TDI 16V - JETTA III-IV - PASSAT 1.6 TDI 16V - POLO - TOURAN 1.6 TDI 16V

DESCRIPTION	P/N	CROSS REFERENCES				
		OE	RNZ	EK	AJ	PY
HEAD SET WITHOUT H.G. WITH OIL SEALS	044218-1099		02-40983-01 + 15-40486-01	236.170	53036000	
CYLINDER HEAD COVER SET 5 PCS	114220-0000 ^A	03L103483C + 03L103070 (4X)	15-40486-01	380.440	11122200	

^A For Cylinder Head Cover 03L103469C-R / 03L103475C-R

104224-5250

CYLINDER HEAD GASKET - GUARNIZIONE TESTATA VW GROUP



114224-0000

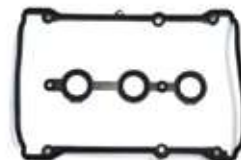

ENGINES* | MOTORI*

DISPLACEMENT | CILINDRATA

—
2.8 30V

CODE | CODICE

—
ACK / AGE / ALG / AMX / APR / AQD / ATQ / ATX / BBG
From / Dal 2015

MODELS* | MODELLI*

AUDI

—
A4 (802-B5) 2.8 - 2.8 QUATTRO / A4 AVANT (805-B5) 2.8 30V
A6 (4A2-4B2-C4) 2.8 - 2.8 QUATTRO / A6 AVANT(4A5-4B5-C4) 2.8 30V
A8 (4D2-4D8) 2.8 - 2.8 QUATTRO 30V

SKODA

—
SUPERB(3V4) 2.8 V6 30V

VOLKSWAGEN

—
PASSAT (3B2) 2.8 V6-SYNCHRO-4MOTION / PASSAT VARIANT (3B5) 2.8 V6 30V

DESCRIPTION DESCRIZIONE	P/N		CROSS REFERENCES CORRISPONDENZE			
	GA	OE	RNZ	EK	AJ	PY
CYLINDER HEAD GASKET, MLS GUARNIZIONE TESTATA, MLS	104224-5250	078103383L 078103383R	61-31875-00	632.565	10102800	
CYLINDER HEAD COVER GASKET SET KIT GUARNIZIONI COPRITESTATA	114224-0000	078198025	15-31798-01	040.050	56003500	HM5224

*Find out our complete range: www.athena.eu | *Per ulteriori informazioni consultate il catalogo online nel nostro sito: www.athena.eu

044233-1099

VW GROUP

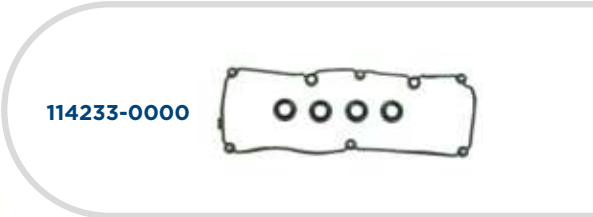

ENGINES* | MOTORI*

DISPLACEMENT
1.6Tdi 16V

CAYA - CAYB - CAYC - CAYD - CAYE - CLNA

MODELS* | MODELLI*

AUDI

A1 - A3 1.6 Tdi 16V

SEAT

ALTEA - IBIZA V - LEON II - TOLEDO IV 1.6 Tdi

SKODA

FABIA II - OCTAVIA II - RAPID - ROOMSTER - SUPERB 1.6 Tdi

VW

BEETLE - GOLF VI - JETTA III-IV - PASSAT - POLO - TOURAN 1.6 Tdi

DESCRIPTION	P/N	CROSS REFERENCES				
		OE	RNZ	EK	AJ	PY
HEAD SET WITHOUT H.G. WITH OIL SEALS	044233-1099		02-40983-01 + 15-40484-01	589.830	53036000	CH7600
CYLINDER HEAD COVER SET	114233-0000	03L 103 483H + 03L 103 070 A (4x)	15-40484-01	449.390		

For cylinder head cover 03L103469H - 03L103475H

084218-1000 VW GROUP

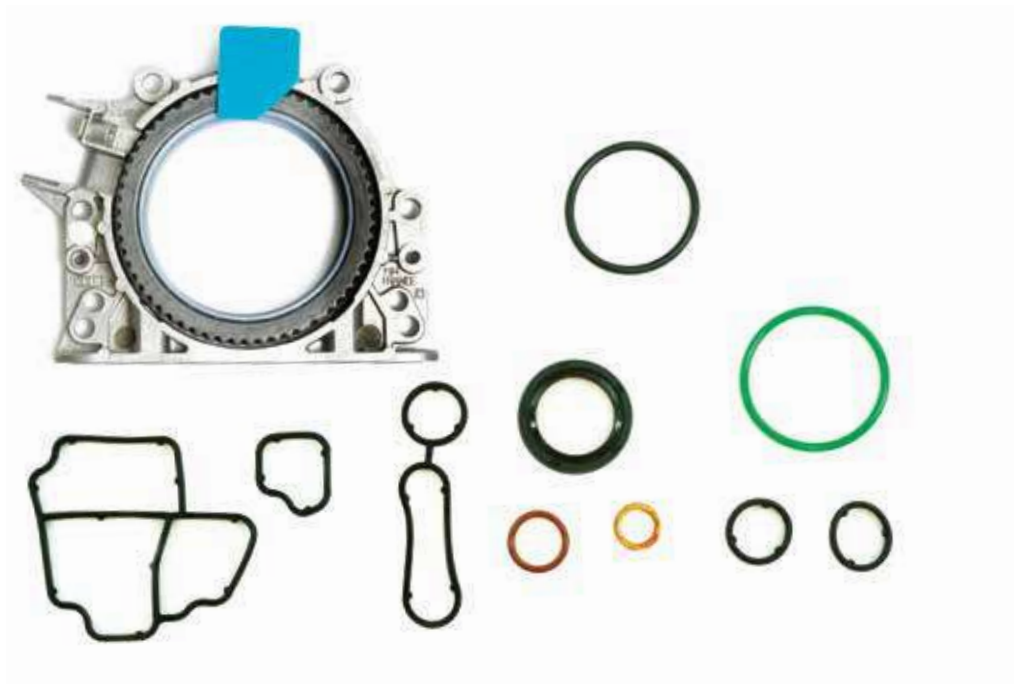

ENGINES* | MOTORI*

DISPLACEMENT
1.6 - 2.0 TDI 16V

CAYA - CAYB - CAYC - CAYD - CAYE - CLNA - CFFA - B - GB - GC - GD - CFHB - D - CGLA - LB - LC - CJCA - CB - CC - CD - CLLB - CMFA etc.

MODELS* | MODELLI*

AUDI

A1 - A3 1.6 TDI 16V

SEAT

ALTEA - IBIZA IV - LEON - TOLEDO IV 1.6 TDI

SKODA

FABIA II - OCTAVIA II - RAPID - ROOMSTER - SUPERB II 1.6 TDI

VW

BEETLE - GOLF VI - JETTA III-IV - PASSAT - POLO - TOURAN 1.6 TDI

DESCRIPTION	P/N	CROSS REFERENCES				
		OE	RNZ	EK	AJ	PY
CRANKCASE GASKET SET	084218-1000 ^A		08-40847-01 + 08-40848-01	236.040	54176000	

^A With rear Integrated crankshaft oil seal p/n 997017-6900

*Find out our complete range: www.athena.eu | *Per ulteriori informazioni consultate il catalogo online nel nostro sito: www.athena.eu

104218-5251

CYLINDER HEAD GASKET - GUARNIZIONE TESTATA VW GROUP



ENGINES* | MOTORI*

DISPLACEMENT | CILINDRATA

—
1.6TDI16V

CODE | CODICE

—
CAYA - CAYB - CAYC - CAYD - CAYE - CLNA

MODELS* | MODELLI*

AUDI

—
A1 - A3 1.6 TDI 16V

SEAT

—
ALTEA - IBIZA V 1.6 TDI 16V - LEON II - TOLEDO IV 1.6 TDI 16V

SKODA

—
FABIA II - OCTAVIA II 1.6 TDI 16V - RAPID - ROOSTER 1.6 TDI 16V
SUPERB - YETI 1.6 TDI 16V

VW

—
ALTEA - IBIZA V 1.6 TDI 16V - LEON II - TOLEDO IV 1.6 TDI 16V
BEETLE - CADDY III 1.6 TDI 16V
GOLF VI - GOLF PLUS 1.6 TDI 16V
JETTA III-IV - PASSAT 1.6 TDI 16V
POLO _ TOURAN 1.6 TDI 16V

DESCRIPTION DESCRIZIONE	P/N		CROSS REFERENCES CORRISPONDENZE			
	GA	OE	RNZ	EK	AJ	PY
CYLINDER HEAD GASKET, MLS TH. 1,55 mm 1 NOTCH GUARNIZIONE TESTATA, MLS SP. 1,55 mm 1 TACCA	104218-5251 *A	03L103383J-BQ-BT	61-36360-00	732.090	10195700	
CYLINDER HEAD GASKET, MLS TH. 1,63 mm 2 NOTCHES GUARNIZIONE TESTATA, MLS SP. 1,63 mm 2 TACCHE	104218-5252 *B	03L103383K-BR-CA	61-36360-10	732.100	10195710	
CYLINDER HEAD GASKET, MLS TH. 1,71 mm 3 NOTCHES GUARNIZIONE TESTATA, MLS SP. 1,71 mm 3 TACCHE	104218-5253 *C	03L103383L-BS-CB	61-36360-20	732.110	10195720	

*A **Cancels and supercedes p/n 104218-3851** - Annulla e sostituisce il precedente codice 104218-3851

*B **Cancels and supercedes p/n 104218-3852** - Annulla e sostituisce il precedente codice 104218-3852

*C **Cancels and supercedes p/n 104218-3853** - Annulla e sostituisce il precedente codice 104218-3853

104742-5251

VW GROUP



ENGINES* | MOTORI*

DISPLACEMENT
1.9 D-TD
 —
 1Y - AAZ - AEF

MODELS* | MODELLI*

AUDI
 —
 80 1.9 D-TD

SEAT
 —
 CORDOBA - IBIZA II - INCA - TOLEDO -1.9D-TD

SKODA
 —
 FELICIA 1.9D

VW
 —
 GOLF III - PASSAT 1.9 D-TD - POLO -VENTO - TRANSPORTER 1.9D

DESCRIPTION	P/N	CROSS REFERENCES				
		OE	RNZ	EK	AJ	PY
MLS HEAD GASKET TH. 1,53 MM - 1 HOLE	104742-5251 ^A	028103383BH	61-31225-30	914.848	10103000	BV850
MLS HEAD GASKET TH. 1,57 MM - 2 HOLES	104742-5252 ^B	028103383BJ	61-31225-40	914.856	10103010	BV860
MLS HEAD GASKET TH. 1,61 MM - 3 HOLES	104742-5253 ^C	028103383BK	61-31225-50	914.873	10103020	BV870

^A Cancels and supercedes p/n 104742-3851

^B Cancels and supercedes p/n 104742-3852

^C Cancels and supercedes p/n 104742-3853

104745-5251

VW GROUP - FORD



ENGINES* | MOTORI*

DISPLACEMENT
1.9 SDI-Tdi

IZ - AEY - AFD - AFF - AFN - AGD - AHB - AHG - AHH - AHU - AKU
AKW - ALE - ASX - AVG

MODELS* | MODELLI*

AUDI

80 - A4 - A6 1.9 Tdi

FORD

GALAXY 1.9 TD

SEAT

ALHAMBRA - CORDOBA - IBIZA II - INCA - TOLEDO -1.9 SDI-Tdi

SKODA

OCTAVIA 1.9 Tdi

VW

GOLF III-IV - LUPO - PASSAT 1.9 D-TD - POLO -VENTO - SHARAN 1.9 SDI-Tdi

DESCRIPTION	P/N	CROSS REFERENCES				
		OE	RNZ	EK	AJ	PY
MLS HEAD GASKET TH. 1,45 MM - 1 HOLE	104745-5251 ^A	028103383BP	61-33120-30	412.872	10094900	BX800
MLS HEAD GASKET TH. 1,53 MM - 2 HOLES	104745-5252 ^B	028103383BQ	61-33120-40	412.882	10094910	BX810
MLS HEAD GASKET TH. 1,61 MM - 3 HOLES	104745-5253 ^C	028103383BR	61-33120-50	412.912	10094920	BX820

^A Cancels and supercedes p/n 104745-3851

^B Cancels and supercedes p/n 104745-3852

^C Cancels and supercedes p/n 104745-3853

104768-5251

VW GROUP



ENGINES* | MOTORI*

DISPLACEMENT

1.9 SDI-Tdi

—
AGP - AGR - AHF - ALH - ANC - AQM - ARD - ASV - ASY - AVM - AYQ
BEQ - BEU - BGL - BGM - BJC - BXT - CDXA - CDXB
FROM ENGINE 140001-151001 etc.

MODELS* | MODELLI*

AUDI

—
A3 1.9 Tdi

SEAT

—
CORDOBA - IBIZA III - INCA - LEON - TOLEDO II -1.9 SDI-Tdi

SKODA

—
FABIA - OCTAVIA 1.9 SDI-Tdi

VW

—
BORA - GOLF IV - NEW BEETLE - POLO 1.9 SDI-Tdi

DESCRIPTION	P/N	CROSS REFERENCES				
		OE	RNZ	EK	AJ	PY
MLS HEAD GASKET TH. 1,55 MM - 1 HOLE	104768-5251	038103383AL-H	61-31980-00	123.992	10121200	BZ040
MLS HEAD GASKET TH. 1,63 MM - 2 HOLES	104768-5252	038103383AM-J	61-31980-10	124.002	10121210	BZ050
MLS HEAD GASKET TH. 1,71 MM - 3 HOLES	104768-5253	038103383AN-K	61-31980-20	124.012	10121220	BZ060

*Find out our complete range: www.athena.eu | *Per ulteriori informazioni consultate il catalogo online nel nostro sito: www.athena.eu

114768-8000
VW GROUP



ENGINES* | MOTORI*

DISPLACEMENT
1.9 SDI - TDI 8V

AGP - AGR - AHF - ALH - AQM - ASK - ASV - ASY - AYQ

MODELS* | MODELLI*

AUDI

A3 1.9 Tdi 8V

SEAT

CORDOBA - IBIZA II-III - INCA - LEON - TOLEDO II 1.9 Tdi 8V

SKODA

FABIA I - OCTAVIA I 1.9 SDI 8V

VW

BORA - CADDY II - FOX - GOLF IV - NEW BEETLE - POLO - 1.9 SDI-Tdi 8V

DESCRIPTION	P/N	CROSS REFERENCES				
		OE	RNZ	EK	AJ	PY
CYLINDER HEAD COVER	114768-8000					

Item not provided by the original replacement.
 Can be used on cylinder head cover n° 038103469E also combined with head set without h.g. p/n 044768-1000.

084768-1000

VW GROUP - FORD



ENGINES* | MOTORI*

DISPLACEMENT
1.9 - 2.0 TDI

AGP - AGR - AHF - ALH - ANC - AQM - ARD - ASV - ASY - AVM - AYQ
BEQ - BEU - BGL - BGM - BJC - BXT - CDXA - CDXB

MODELS* | MODELLI*

AUDI

A3 - A4 - AVANT - A6 1.9 Tdi - A4-A4 AVANT 2.0 Tdi

FORD

GALAXY 1.9 Tdi

SEAT

ALHAMBRA - ALTEA - CORDOBA - IBIZA II-IV - LEON - TOLEDO II 1.9 Tdi

SKODA

FABIA - OCTAVIA I-II - ROOMSTER 1.9 Tdi - SUPERB 1.9 - 2.0 Tdi

VW

GOLF IV - NEW BEETLE - POLO - SHARAN 1.9 Tdi - PASSAT 1.9 - 2.0 Tdi

DESCRIPTION	P/N	CROSS REFERENCES				
		OE	RNZ	EK	AJ	PY
CRANKCASE GASKET SET	084768-1000 ^A	038198011	08-31414-03 ^B 08-35038-01	530.541 189.530	54091100 ^B 53138600 ^B	EC060 ^B

^A With rear integrated crankshaft oil seal p/n 997012-6900

^B IOS seal not included

104791-5251

VW GROUP - FORD



ENGINES* | MOTORI*

DISPLACEMENT
1.9 Tdi

AJM - ANU - ARL - ASZ - ATD - ATJ - AUY - AVB - AVF - AVQ - AWX - AXB - AXC
BJB - BKC - BKE - BLS - BLT - BMT - BPX - BSV - BXE - BXF etc.

MODELS* | MODELLI*

AUDI

A3 - A4 - A6 1.9 Tdi

FORD

GALAXY 1.9 Tdi

SEAT

ALHAMBRA - ALTEA - CORDOBA - IBIZA III-IV - LEON - TOLEDO II-III -1.9 Tdi

SKODA

FABIA - OCTAVIA - ROOMSTER - SUPERB I-II 1.9 Tdi

VW

BORA - GOLF IV-V - JETTA- PASSAT - POLO - SHARAN - TOURAN 1.9 Tdi
CADDY III - TRANSPORTER V 1.9 Tdi

DESCRIPTION	P/N	CROSS REFERENCES				
		OE	RNZ	EK	AJ	PY
MLS HEAD GASKET TH. 1,45 MM - 1 HOLE	104791-5251 ^A	038103383BL-DE	61-34250-00	150.153	10177000	AF5382
MLS HEAD GASKET TH. 1,53 MM - 2 HOLES	104791-5252 ^B	038103383BM-DF	61-34250-10	150.162	10177010	AF5392
MLS HEAD GASKET TH. 1,61 MM - 3 HOLES	104791-5253 ^C	038103383BN-DG	61-34250-20	150.172	10177020	AF5402

^A Interchangeable with p/n 104791-3851

^B Interchangeable with p/n 104791-3852

^C Interchangeable with p/n 104791-3853

044797-1051 MITSUBISHI - VW GROUP

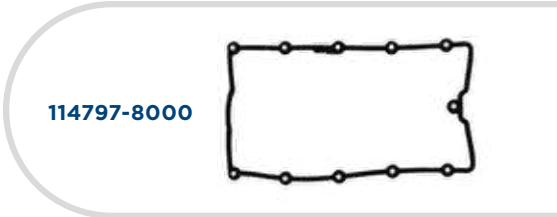
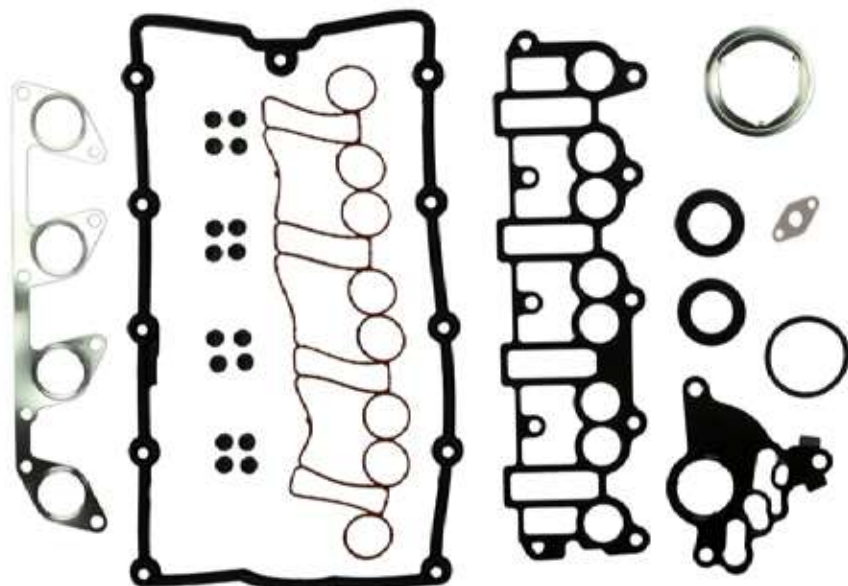

ENGINES* | MOTORI*

DISPLACEMENT
2.0 TDI 16V
2.0 DI-D 16V

—
AZV - BKD-P - BMA- BSY
BVD - BVE - BWC - BWV

MODELS* | MODELLI*

AUDI

—
A3 2.0 TDI 16V - A4 2.0 TDI 16V - A6 2.0 TDI 16V

MITSUBISHI

—
OUTLANDER II 2.0 DI-D 16V (CW8W)

SEAT

—
ALTEA 2.0 TDI 16V - LEON II - TOLEDO III 2.0 TDI 16V

SKODA

—
OCTAVIA II 2.0 TDI 16V - SUPERB 2.0 TDI 16V

VW

—
GOLF V - GOLF PLUS 2.0 TDI 16V - JETTA III - PASSAT 2.0 TDI 16V - TOURAN 2.0 TDI 16V

DESCRIPTION	P/N	CROSS REFERENCES				
		OE	RNZ	EK	AJ	PY
UNIFIED HEAD SET WITHOUT H.G. WITH OIL SEALS	044797-1051 ^A		02-36041-01	490.921 722.320	53020300 53025000	CG8410
CYLINDER HEAD COVER	114797-8000	03G103483	71-36041-00	005.910	11101700	JM7031

^A Cancels and supercedes p/n 044797-1000

*Find out our complete range: www.athena.eu | *Per ulteriori informazioni consultate il catalogo online nel nostro sito: www.athena.eu

104797-5251

VW GROUP - MITSUBISHI



ENGINES* | MOTORI*

DISPLACEMENT
2.0 Tdi 16V

AZV - BKD - BKP - BLB - BMA - BMN - BMR - BNA - BRD - BRE - BRF
BSY - BUY - BUZ - BVA - BVE - BVF - BVG - BWC - BWE

MODELS* | MODELLI*

AUDI

A3 - A4 - A6 2.0 Tdi 16V

MITSUBISHI

GRANDIS - OUTLANDER II 2.0 DI-D 16V

SEAT

ALTEA - LEON II - TOLEDO III -2.0 Tdi 16V

SKODA

OCTAVIA II - SUPERB 2.0 Tdi 16V

VW

GOLF V - JETTA III - PASSAT - TOURAN 2.0 Tdi 16V

DESCRIPTION	P/N	CROSS REFERENCES				
		OE	RNZ	EK	AJ	PY
MLS HEAD GASKET TH. 1,55 MM - 1 HOLE	104797-5251^A	03G103383AA	61-33770-00	150.380	10167000	AG8970
MLS HEAD GASKET TH. 1,63 MM - 2 HOLES	104797-5252^B	03G103383AB	61-33770-10	150.390	10167010	AG8800
MLS HEAD GASKET TH. 1,71 MM - 3 HOLES	104797-5253^C	03G103383AC	61-33770-20	150.400	10167020	AG8960

^A Interchangeable with p/n 104797-3851

^B Interchangeable with p/n 104797-3852

^C Interchangeable with p/n 104797-3853

044226-1099
VW GROUP



ENGINES* | MOTORI*

DISPLACEMENT
 1.9 - 2.0 Tdi 8V

BLS - BMM - BMP - BMT - BRM - BSU - BXJ - CBHA - CBKA

MODELS* | MODELLI*

AUDI

AUDI A3 1.9 TDI - 2.0 TDI

SEAT

ALTEA - CORDOBA - IBIZA III-IV 1.9 TDI
 ALTEA - XL - LEON - TOLEDO 2.0 TDI

SKODA

FABIA 1.9 TDI - OCTAVIA II 1.9-2.0 TDI - SUPERB 1.9-2.0 TDI

VW

CADDY III - GOLF V - JETTA III - PASSAT - TOURAN 1.9-2.0 TDI

DESCRIPTION	P/N	CROSS REFERENCES				
		OE	RNZ	EK	AJ	PY
HEAD SET WITHOUT H.G. WITH OIL SEALS	044226-1099		02-37594-01	548.181	53024200	
CYLINDER HEAD COVER	114226-8000	03G 103 483D	71-37594-00	542.000	11111500	JM7107

*Find out our complete range: www.athena.eu | *Per ulteriori informazioni consultate il catalogo online nel nostro sito: www.athena.eu

044220-1099

VW GROUP

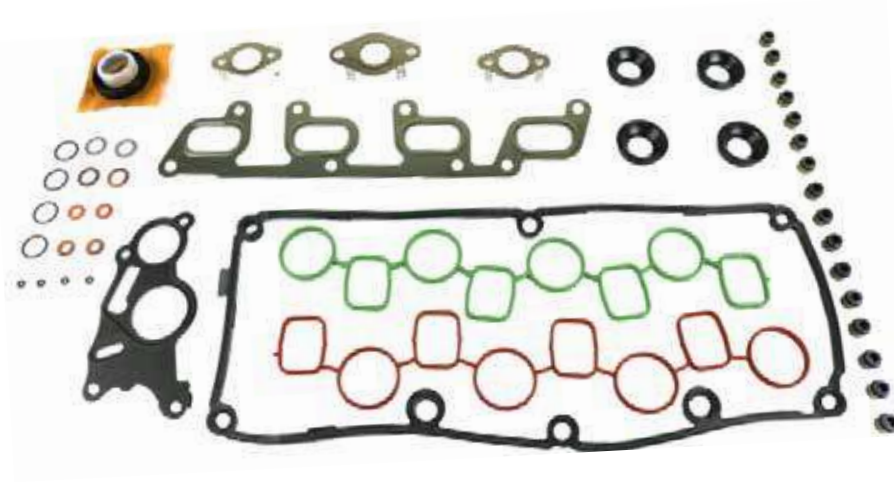

114220-0000

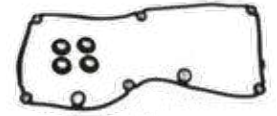

ENGINES* | MOTORI*

**DISPLACEMENT
2.0 TDI 16V**

—
 CAAA-B-C-D-E-HA-HB
 CFFA-B-D-E-HA-HB-HC-HD-HE-HF-JA
 CGLA-B-E-CJCA-B-C-D
 CLCA-B-JA-CHFA-B-GA

MODELS* | MODELLI*

AUDI

—
 A1 - A3 - A4 - A5 - A6 2.0 TDI 16V

SEAT

—
 ALHAMBRA - ALTEA 2.0 TDI 16V - EXEO - IBIZA V - LEON II 2.0 TDI 16V

SKODA

—
 OCTAVIA II 2.0 TDI 16V - SUPERB - YETI 2.0 TDI 16V

VW

—
 BEETLE-CADDY III - EOS 2.0 TDI 16V - GOLF VI - GOLF PLUS 2.0 TDI 16V - JETTA
 IV - PASSAT 2.0 TDI 16V - SCIROCCO - SHARAN 2.0 TDI 16V - TIGUAN - TOURAN
 2.0 TDI 16V

DESCRIPTION	P/N	CROSS REFERENCES				
		OE	RNZ	EK	AJ	PY
UNIFIED HEAD SET WITHOUT H.G. WITH OIL SEALS	044220-1099		02-40486-01	236.340		
CYLINDER HEAD COVER SET 5 PCS	114220-0000	03L103483C + 03L103070 (4X)	15-40486-01	380.440		

*Find out our complete range: www.athena.eu | *Per ulteriori informazioni consultate il catalogo online nel nostro sito: www.athena.eu

104220-5252

VW GROUP



ENGINES* | MOTORI*

DISPLACEMENT

2.0 TDI 16V

—

CAAA-B-C-D-E - CCHA-B - CDBA-CA - CFCA-FA-B-GB-GC-GD-HA ETC. - CGLA - CJCA - CLJA-B - CHFA-B - CLLA - CNEA-FA - CSHA-NA etc.

MODELS* | MODELLI*

AUDI

—

A1 - A3 - A4 - A5 - A6 - Q3 - Q5 2.0 TDI 16V

SEAT

—

ALHAMBRA - ALTEA - EXEO - IBIZA IV - LEON 2.0 TDI 16V

SKODA

—

OCTAVIA II - SUPERB II - YETI 2.0 TDI 16V

VW

—

BEETLE - CADDY III - EOS - GOLF VI - JETTA IV 2.0 TDI 16V PASSAT - SCIROCCO - SHARAN - TIGUAN - TOURAN 2.0 TDI 16V

DESCRIPTION	P/N	CROSS REFERENCES				
		OE	RNZ	EK	AJ	PY
MLS HEAD GASKET TH. 1,63 MM - 2 NOTCHES	104220-5252 ^A	03L103383AK-BG-BN	61-37600-10	726.840	10195910	
MLS HEAD GASKET TH. 1,71 MM - 3 NOTCHES	104220-5253 ^B	03L103383AL-BM-BP	61-37600-20	726.850	10195920	

^A Interchangeable with p/n 104220-3852

^B Interchangeable with p/n 104220-3853

044752-1000

CYLINDER HEAD GASKET SET - KIT GUARNIZIONI TESTATA VW GROUP



114752-0000



ENGINES* | MOTORI*

DISPLACEMENT | CILINDRATA

2.4 DS 10V

CODE | CODICE

3D - AAS - AAB
Up chassis/Fino telaio 70-R-160-000

MODELS* | MODELLI*

AUDI

100 - 100 AVANT (44-44Q-C3) 2.4 D 10V
100 - 100 AVANT (4A5-C4) 2.4 D 10V

VOLKSWAGEN

TRANSPORTER IV 70A - 70B - 70C - 70E - 70H - 70L - 70M - 70J - 70K 2.4 D 10V
TRANSPORTER IV 70DA - 70DB - 70DE - 70DK - 2.4 D 10V

DESCRIPTION DESCRIZIONE	P/N		CROSS REFERENCES CORRISPONDENZE			
	GA	OE	RNZ	EK	AJ	PY
CYLINDER HEAD GASKET SET, WITHOUT H.G., WITH OIL SEALS KIT GUARNIZIONI TESTATA, SENZA T.C., CON PARAOLI	044752-1000	74198012	02-28988-01 02-28988-03	915.173	53005800	DW830
CYLINDER HEAD COVER GASKET SET KIT GUARNIZIONE COPRITESTATA	114752-0000	074198025B	15-28988-01	915.580	56006500	

104751-5251

CYLINDER HEAD GASKET - GUARNIZIONE TESTATA VW GROUP - VOLVO



ENGINES* | MOTORI*

DISPLACEMENT | CILINDRATA

2.5 D. 10V

CODE | CODICE

IT - AAT - ABP - ACV - AEL - AGX - AHD - AHY - AJT - ANF - ANG - ANH - ANJ - APA -
AUF - AUR - AXG - AXL - AYC - AYY - BBE - BBF - BBR - BCT - BCU - BCV - BTW

MODELS* | MODELLI*

AUDI

100 AVANT 2.5 TDI 10V
A6 AVANT 2.5 TDI 10V

VW

LT 28-35 II - 28-46 II 2.5 SDI-TDI 10V
TRANSPORTER IV 2.5 TDI 10V

VOLVO

S70 - S80 - V70 I-II - 850 2.5 TDI 10V

DESCRIPTION DESCRIZIONE	P/N		CROSS REFERENCES CORRISPONDENZE			
	GA	OE	RNZ	EK	AJ	PY
CYLINDER HEAD GASKET, MLS TH. 1,53 mm 1 NOTCH GUARNIZIONE TESTATA, MLS SP. 1,53 mm 1 TACCA	104751-5251 *A	074103383AJ 8658621	61-31950-30	235.421	10131400	AF5310
CYLINDER HEAD GASKET, MLS TH. 1,57 mm 2 NOTCHES GUARNIZIONE TESTATA, MLS SP. 1,57 mm 2 TACCHE	104751-5252 *B	074103383AH 8658620	61-31950-40	235.381	10131410	AF5320
CYLINDER HEAD GASKET, MLS TH. 1,61 mm 3 NOTCHES GUARNIZIONE TESTATA, MLS SP. 1,61 mm 3 TACCHE	104751-5253 *C	074103383AG 8658619	61-31950-50	230.521	10131420	AF5330

*A **Cancels and supercedes p/n 104751-3851** - Annulla e sostituisce il precedente codice 104751-3851

*B **Cancels and supercedes p/n 104751-3852** - Annulla e sostituisce il precedente codice 104751-3852

*C **Cancels and supercedes p/n 104751-3853** - Annulla e sostituisce il precedente codice 104751-3853

104752-5251

CYLINDER HEAD GASKET - GUARNIZIONE TESTATA VW GROUP



ENGINES* | MOTORI*

DISPLACEMENT | CILINDRATA

2.4 DS 10V

CODE | CODICE

AAB From engine/Dal motore 110.001 - AJA

MODELS* | MODELLI*

VOLKSWAGEN

TRANSPORTER IV 70A - 70B - 70C - 70E - 70H - 70L - 70M - 70J - 70K 2.4 D 10V
TRANSPORTER IV 70DA 70DB - 70DE - 70DK - 2.4 D 10V

DESCRIPTION DESCRIZIONE	P/N		CROSS REFERENCES CORRISPONDENZE			
	GA	OE	RNZ	EK	AJ	PY
CYLINDER HEAD GASKET, MLS 1,53 mm, 1 NOTCH GUARNIZIONE, TESTATA, MLS 1,53 mm, 1 TACCA	104752-5251 ^A	074103383M	61-29471-30	632.111	10103300	AF5340
CYLINDER HEAD GASKET, MLS 1,57 mm, 2 NOTCHES GUARNIZIONE, TESTATA, MLS 1,57 mm, 2 TACCHE	104752-5252 ^B	074103383N	61-29471-40	632.121	10103310	AF5350
CYLINDER HEAD GASKET, MLS 1,61 mm, 3 NOTCHES GUARNIZIONE, TESTATA, MLS 1,61 mm, 3 TACCHE	104752-5253 ^C	074103383P	61-29471-50	632.131	10103320	AF5360

^A **Cancels and supercedes 104752-3851** - Annulla e sostituisce 104752-3851

^B **Cancels and supercedes 104752-3852** - Annulla e sostituisce 104752-3852

^C **Cancels and supercedes 104752-3853** - Annulla e sostituisce 104752-3853

044231-1099

VW GROUP



ENGINES* | MOTORI*

DISPLACEMENT
2.0 Tdi 16V

—
CDBA - CKTB - CNFA - CNFB - CSHA etc.

MODELS* | MODELLI*

VW GROUP

—
AMAROK 2.0 TDI - BITDI
CRAFTER 30-35-50 2.0 TDI

DESCRIPTION	P/N	CROSS REFERENCES				
		OE	RNZ	EK	AJ	PY
HEAD SET WITHOUT H.G. WITH OIL SEALS	044231-1099		02-40486-03	330.250		

*Find out our complete range: www.athena.eu | *Per ulteriori informazioni consultate il catalogo online nel nostro sito: www.athena.eu

104231-5252

NEW

CYLINDER HEAD GASKET - GUARNIZIONE TESTATA
VW GROUP



ENGINES* | MOTORI*

DISPLACEMENT | CILINDRATA

2.0 TDI 16V

CODE | CODICE

CKTB - CKTC - CKUB - CKUC - CNEA - CNEB - CSHA - CSLA - CSLB - CSLC - CSNA

MODELS* | MODELLI*

VOLKSWAGEN

AMAROK (S1B) 2.0 BITDI (FROM 08.2014)
CRAFTER (2E_) 2.0 TDI (FROM 11.2013)
CRAFTER (2F_) 2.0 TDI (FROM 11.2013)

DESCRIPTION DESCRIZIONE	P/N		CROSS REFERENCES CORRISPONDENZE			
	GA	OE	RNZ	EK	AJ	PY
CYLINDER HEAD GASKET, MLS TH. 1,63mm 2 NOTCH GUARNIZIONE TESTATA, MLS SP. 1,63mm 2 TACCHE	104231-5252	03L103383DD	61-10140-10	789.873	10220410	
CYLINDER HEAD GASKET, MLS TH. 1,71mm 3 NOTCH GUARNIZIONE TESTATA, MLS SP. 1,71mm 3 TACCHE	104231-5253	03L103383DE	61-10140-20	789.883	10220420	

*Find out our complete range: www.athena.eu | *Per ulteriori informazioni consultate il catalogo online nel nostro sito: www.athena.eu

094772-1000 VW GROUP



ENGINES* | MOTORI*

DISPLACEMENT

1.2 TDI - 1.4 TDI - 1.9 TDI

—

AJM - AMF - ANU - ANY - ARL - ASZ - ATD - ATJ - ATL - AVB - BLK - BMC - BMS - BMT
- BKC - BNV
BPU - BRS

MODELS* | MODELLI*

AUDI

—

A2 - A3 - A4 - A6

SEAT

—

ALHAMBRA - ALTEA - CORDOBA - IBIZA - LEON - TOLEDO

SKODA

—

FABIA - OCTAVIA - ROOMSTER - SUPERB

VW

—

CADDY III - FOX - GOLF IV - V - PLUS
JETTA III - PASSAT

DESCRIPTION	P/N	CROSS REFERENCES				
		OE	RNZ	EK	AJ	PY
INJECTION NOZZLE REPAIR KIT	094772-1000 ^A	038198051C	15-38642-03	900.650		

^A With bolt

*Find out our complete range: www.athena.eu | *Per ulteriori informazioni consultate il catalogo online nel nostro sito: www.athena.eu

094797-1000

VW GROUP



ENGINES* | MOTORI*

DISPLACEMENT
1.9 TDI

—

AZV - BKD - BLB - BNA - BRE - BRF - BVF - BVG

MODELS* | MODELLI*

AUDI

—

A3 - A4 - A6

SEAT

—

ALTEA - CORDOBA - BIZA - LEON - TOLEDO

SKODA

—

OCTAVIA - SUPERB

VW

—

GOLF V-PLUS - JETTA III - TOURAN

DESCRIPTION	P/N	CROSS REFERENCES				
		OE	RNZ	EK	AJ	PY
INJECTION NOZZLE REPAIR KIT	094797-1000 ^A	03G198051A	15-38642-04	235.590		

^A With bolt

094228-1000

VW GROUP



ENGINES* | MOTORI*

DISPLACEMENT
1.9 TDI - 2.0 TDI

—
BKP - BMA - BMN - BMR - BRD - BUY - BUZ
BVA - BVE - MWV - BXE

MODELS* | MODELLI*

AUDI

—
A3 - A4

SEAT

—
ALTEA - LEON - TOLEDO

SKODA

—
OCTAVIA

VW

—
GOLF V - JETTA III - PASSAT - TOURAN

DESCRIPTION	P/N	CROSS REFERENCES				
		OE	RNZ	EK	AJ	PY
INJECTION NOZZLE REPAIR KIT	094228-1000	03G198051D	15-42119-01	690.170		

^ With bolt

*Find out our complete range: www.athena.eu | *Per ulteriori informazioni consultate il catalogo online nel nostro sito: www.athena.eu

ATHESIL SILICONE SEALANT - SIGILLANTE SILICONICO



M813002000001

- **80 ml TUBE**
TUBETTO SINGOLO 80 ml

P300000999002

- **BOX 12 TUBES**
CONFEZIONE 12 PZ.

RTV UNIVERSAL SILICONE SEALANT FOR PROFESSIONAL USE SIGILLANTE SILICONICO UNIVERSALE RTV PER USO PROFESSIONALE

Athena proudly introduces Athesil, the new single-component RTV silicone compound Made in Germany to answer the specific needs of professional technicians and mechanics in the automotive, marine, motorcycle, heavy duty and off-road industries. Athesil bonds, seals, repairs, and secures, and is excellent for formed-in-place gasketing (FIPG).

Athesil is a room-temperature-vulcanizing (RTV) silicone, it is non-flammable, and it is MEKO-free certified: it contains no solvents or carcinogenic substances, and does not release corrosive vapors while curing.

Athena presenta Athesil, il nuovo sigillante silconico RTV monocomponente Made in Germany sviluppato secondo le esigenze specifiche di tecnici e professionisti del settore automotive, nautico, motociclistico, industriale e fuoristrada.

Athesil unisce, sigilla, ripara, corregge e fissa, e può essere utilizzato come guarnizione "formed-in-place" (FIPG).

Athesil polimerizza con l'esposizione all'umidità dell'aria, non è infiammabile ed è certificato MEKO-Free: non contiene solventi né sostanze cancerogene, e non rilascia vapori corrosivi durante la presa.

MEASURABLE VARIABLES VARIABILI MISURATE	VALUE VALORE	TEST STANDARD NORMA DI RIFERIMENTO
DENSITY DENSITÀ	1,22 g/cm ³ + 0,02	DIN EN ISO 1181
ELASTIC RECOVERY RITORNO ELASTICO	> 70%	DIN EN ISO 7389-B
MODULUS 100% MODULO DI ELASTICITÀ 100%	< 0,4 N/mm ²	DIN EN ISO 8339
ELONGATION AT BREAK ALLUNGAMENTO A ROTTURA	> 500%	DIN EN ISO 527-2
TENSILE STRENGTH RESISTENZA ALLA TRAZIONE	1,7N/mm ²	DIN EN ISO 527-2
FIRE BEHAVIOR ACCORDING COMPORTAMENTO AL FUOCO	Classe E	DIN EN ISO 13501

All technical data are based on laboratory tests. ATHENA S.p.A reserves the right to modify or update the characteristics of its product without obligation to anyone. Tutti i dati tecnici si basano su test di laboratorio. ATHENA S.p.A. si riserva il diritto di modificare o aggiornare le caratteristiche del proprio prodotto senza obbligo per nessuno.

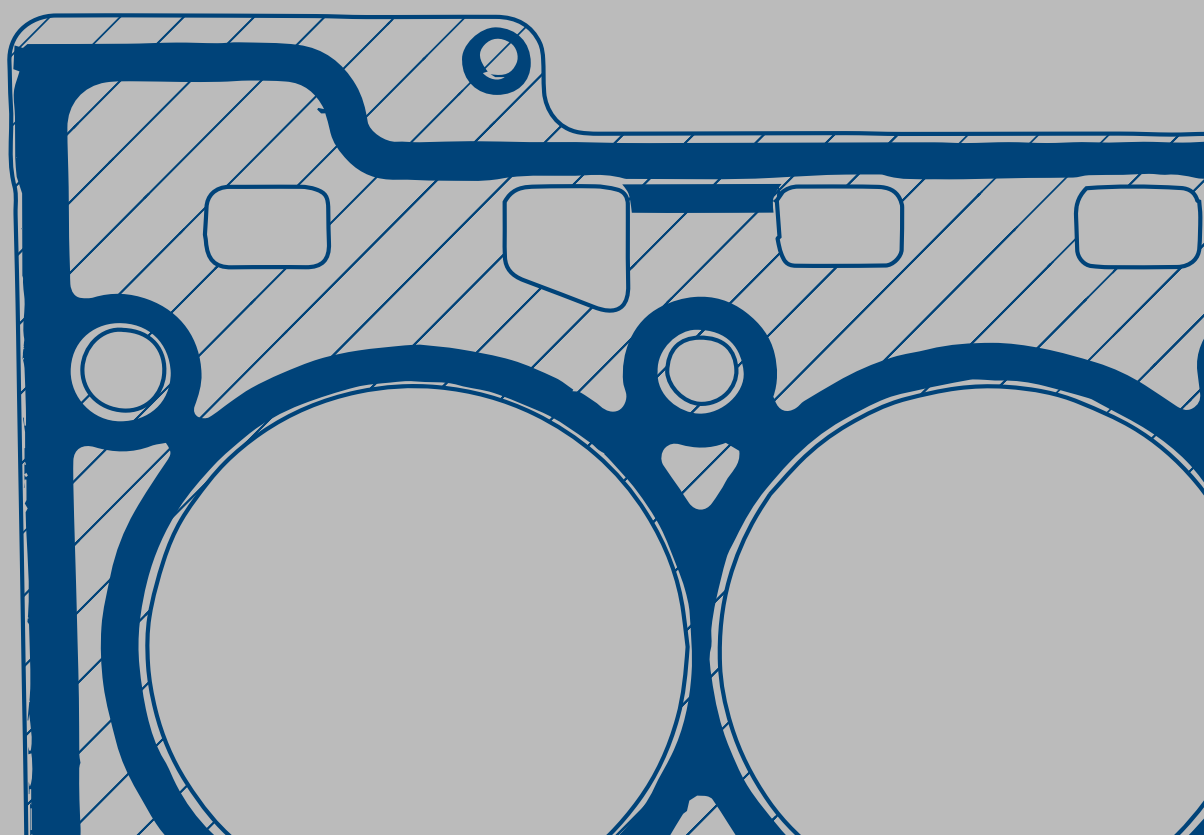

Guarnitauto of **Athena SPA**
via delle Albere 13, 36045 Alonte (VI) - Italia
tel **+39 039 6894456**
mail: auto@athena.eu
www.guarnitauto.com - athena.eu 

A BRAND OF  **ATHENA**